

Professional reference for landscape architects, designers,
specifiers, buyers and hardscape contractors. 11th Edition.



THE RCP HARDSCAPES SPEC GUIDE AND COLOR SELECTOR.

A backyard swimming pool with a brick wall and stone patio. The pool is filled with clear blue water. The patio is made of large, light-colored stone tiles. A brick wall surrounds the pool area. A small white structure is visible in the background. A potted plant with purple flowers sits on the patio near the pool.

**WELCOME TO
THE BACKYARD...**

you're going to love it out here!

WHAT'S INSIDE?

Wet Cast Landscape Tiles

Antique Travertine Landscape Tiles and Garden Wall	8, 30
Barn Plank Landscape Tiles and Garden Wall	6, 31
Slate Landscape Tiles	7, 30

Pavers & Slabs

American Brick Paver.....	14, 33
Barrington Paver	9, 32
Broadmour Pavers	11, 32
Bullnose Paver	43
Cobble Stone Paver	16, 33
Colonial Pavers/Circle Kit	12-13, 30
Holland/Holland-Eco Paver	17, 30
Flagstone Paver	16, 33
Lamont Paver/Circle Kit.....	14-15, 30
Mezzano Paver	10, 32
Minnetonka Paver	9, 32
Serano Paver	10, 32
Turfstone-Eco paver.....	17

Retaining Walls

Antique Travertine Garden Wall	8
Barn Plank Garden Wall	6, 31
Belvedere Wall	39
Classic 6 and 8 Walls	20, 34
Classic 8 DOT Wall and Caps	20, 40
Classic 8 Chiseled Face Wall	21, 35
Classic Colonial 6 and 8 Walls	21, 35
Contemporary Wall.....	19, 35
Compac Wall	23
Cottage Stone Wall	24, 34
Kodah Wall	39
Lakeland Wall	19, 34
Legend Wall	23
Outcropping Wall	38
Premier 8 Wall	22
Recon Wall	25
Riverland Wall	18, 34
Sapphire Wall	22, 34
Standard Wall.....	24
StoneHedge Wall	22
Stonegate Wall.....	23, 34
Travertine Garden Wall.....	8
Vintage 6 Wall	8, 34
Wall Caps	40

Outdoor Living Kits

Bistro, Compact Bar, Dining Table Kits	50
Fireplace Kits	46-48
Fire Ring Kits & Accessories	49
Grand Island Bar Series	50
Seat Wall and Pillar Kits	48
The Kitchen Cabinet Kits	44-45
Waterfall Kits	51
Wood-Fired/Pizza Oven, Woodbox/Stand and Toolkit	51

Accessories

Adhesive	42, 61
Bullet/Classic/Granite Edgers.....	33, 43
Bullnose Paver	43
Cap Blocks	40
Chiseled Caps and Tops	35, 42
Connection Pins (Keystone).....	24
Geo-Grid.....	42
Grand Step	37, 41
Irregular / Dimensional Steps	38
Sleeve-It	42
Snap Edge	42
Stepping Stones	35, 41
Steps (wet cast)	36, 41
Sands, Sealers Cleaners (Alliance)	61

Reference

Classic 6 & 8 Block Construction	56-58
Calculating Paver Material	54
Calculating Retaining Wall Material	55
Color Chart	26
Color Selector	30-37
KolorLast	27-29
Necessories	46
Open Graded Base Construction	10
Vintage 6 Basic Installation.....	59-60
Warranty, Terms & Conditions	62-63
New/Discontinued	4
Staff Directory	5

Planning Your Truckload

The following items can stack on top of other pallets but CANNOT be stacked upon due to pallet size and/or position of product on pallet:

- Antique Travertine Tiles and Bullnose
- Slate Landscape Tiles and Bullnose
- Fire Ring Cap
- Cottage Stone Retaining Wall
- Stepping Stones

LOADING NOTES:

- Grand Fire Ring Kits can be stacked up to three high
- For LTL purposes, each "spot" cannot weigh over 3,000 lbs. stacked
- Weight per pallet includes 50 lbs. for pallets

FREIGHT RATES:

Whether shipping LTL or full loads, dispatchers will find the most competitive freight rate available. Do you need a few pallets to complete a job but can't wait for a full truckload order? Dispatchers will work to get what you need shipped quickly via LTL carrier. LTL shipments less than 15,000 lbs. and 10 pallets are shipped at current rates throughout the Midwest at 1-3 day delivery.

www.rochesterpcp.com



Rochester
Concrete Products™

WHAT'S CHANGING?

New Colors/Products

- **Bullnose Paver**
Natural and Buff
- **3" Tumbled Cap**
Beechwood, Bluestone, Cascade, Santa Fe
- **Grand Fire Ring**
Onyx
- **Sapphire Wall**
Cascade
- **Lakeland and Riverland Walls**
Cascade
- **Mezzano, Serano, Barrington and Minnetonka and 6 x 12** (KolorLast only)

Discontinued Colors

- **Bullnose Paver**
Antique Brown
Beechwood
Charcoal
Desert Buff
Sierra Gray
- **Heritage Blend**
American Brick Paver
- **Carmel**
Colonial Paver
Holland Paver
- **Desert**
Lakeland and Riverland (except kits)
- **Santa Fe**
Grand Step
- **Western Buff**
Slate Landscape Tiles

Discontinued Products

(non-stocking)

- **Lakeland Smooth Wall** (except Lg. Onyx)
- **Country Manor Wall**
- **Big Step**
- **3" Smooth Wall Cap**
- **4" Tumbled Wall Cap**

Available until gone.

Special Order Status

- **Broadmour 10cm Paver**
- **Colonial 8cm Paver**
- **Holland 8cm Paver**
- **Turfstone Eco Paver**
- **Big Step**
- **Classic 8 Colonial Wall**
- **Keystone Standard Wall**
- **Legend Wall**
- **Premier 8 Wall**
- **StoneHedge 6 Wall**

Please Note: Our products are made from solid color concrete for lasting appearance and durability. Photographs contained herein are for representation only. Refer to actual product samples when making color selection. Product dimensions given are nominal in inches, weights in pounds.

The information presented here has been prepared for the benefit of customers interested in Rochester Concrete Products, it was reviewed carefully prior to publication. Rochester Concrete Products assumes no liability for its accuracy or completeness. Final determination of the suitability of any information or material for the use contemplated, or for its manner of use, is the sole responsibility of the user. Not all products available in all areas. Product availability and specifications subject to change without notice.

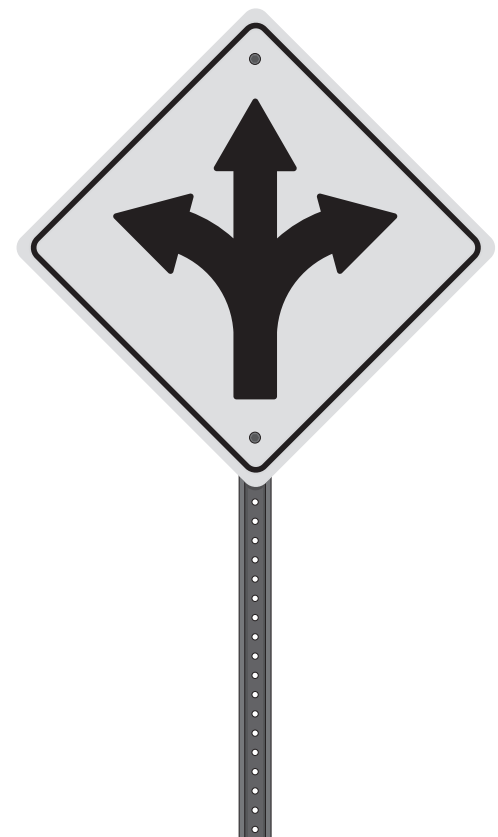

WHO'S WHO?

Sales Staff

Blaine French (Commercial Sales)
612-270-0553
bfrench@rockwoodwalls.com

Chad Peterson (WI)
262-758-2354
chad.peterson@rochesterpcp.com

Crystal Kjellesvik (IL)
630-400-4988
crystal.kjellesvik@rochesterpcp.com

Debra Hyde (WI)
507-254-4116
debra.hyde@rochesterpcp.com

Glen Nevala (MN, SD, ND)
612-702-4115
glen.nevala@rochesterpcp.com

Jeremy Bickner (MN)
612-916-7449
jeremy.bickner@rochesterpcp.com

Jim Weidner (Inside Sales)
507-951-4374
jweidner@moderra.com

John Sheahan (WI)
507-279-2950
john.sheahan@rochesterpcp.com

Kurt Glave (IL, IN)
847-401-3741
kurt.glave@rochesterpcp.com

Scott Gengler (IA, NE)
507-269-6982
scott.gengler@rochesterpcp.com

Travis Lawrence (MN)
612-801-9026
travis.lawrence@rochesterpcp.com

Chris Staszuk (Midwest & E. USA)
517-249-0777
cstaszuk@rockwoodwalls.com

Dispatchers

Cherey Justmann (Beaver Dam)
920-386-3104
cherey.justmann@rochesterpcp.com

Jaime Martinez (Rochester)
507-424-4693
jaime.martinez@rochesterpcp.com

Linda Baker (Beaver Dam)
920-386-3105
linda.baker@rochesterpcp.com

Mark Straub (Jordan)
952-492-3636
mark.straub@rochesterpcp.com

Becky Myre (Jordan)
952-492-4082
becky.myre@rochesterpcp.com

Tanya Kapfer (Thorp)
715-669-5552
tanya.kapfer@rochesterpcp.com

Production/Plants

Corp. Office/Rochester Plant
7200 N Broadway Ave.
Rochester, MN 55906
507-288-8850
507-424-4697 fax

Beaver Dam Plant
W6558 Hwy 33, Juneau, WI 53039
920-386-3333
920-386-4612 fax

Thorp Plant
N14665 Dickerson Ave., Thorp, WI 54771
715-669-5552
715-669-7135 fax

Jordan Plant
3535 Bluff Drive, Jordan, MN 55352
952-492-3636
952-492-3668 fax

Support Staff

Becky Erdman (Warranties and Samples)
507-535-1482
becky.erdman@rochesterpcp.com

Cathy Haggerty (Event Director)
507-535-3501
cathy.haggerty@rochesterpcp.com

David Spies (Marketing Director)
507-535-3507
david.spies@rochesterpcp.com

Jessica Spading (Online Marketing)
507-535-3509
jspading@rockwoodwalls.com

Justin Rueth (Web)
507-535-3524
jrueth@rockwoodwalls.com

Kim Schumacher (Acct's Receivable)
507-535-1493
kim.schumacher@glsindustries.net

Lindsay Birr (Merchandise Manager)
507-535-3512
lindsay.birr@rochesterpcp.com

Online Calculator:
www.rochesterpcp.com/calculator

Online Order Form: Contact your Regional sales representative



www.rochesterpcp.com

Barn Plank Landscape Tiles

Silver Creek Stoneworks

Features

- Deep splits and detailed grain top and sides, three faces each
- Will never rot or warp
- For paths, patios, pools, caps and overlays
- Matching step block, garden wall and fire pit kit
- Strong and durable 10,000 psi concrete

Colors

- Mahogany (color protected)
- Weathered Gray (color protected)

Notes

- Partial pallet quantities available
- To calculate pieces divide total sq. ft. by 5.2
- Exposed to the sun and Mother Nature, Barn Plank will age over time much like real wood.
- Pallets CANNOT be double stacked

Barn Plank tiles are manufactured with a surface applied protectant to help resist the harmful effects of time, Mother Nature, acid rain and stains.

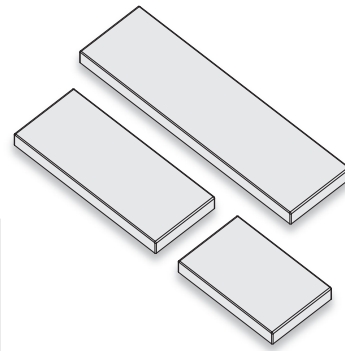

Gap tiles a minimum of 1/4"

Size/Name	Dimensions	Area (ea.)	Weight (ea.)	Units/pallet	Weight/pallet
Small	15.50 x 9.75 x 2" H	1.05 sq. ft.	24 lbs.	40 (42 sq. ft.)	1,010 lbs.
Medium	23.375 x 9.75 x 2" x H	1.59 sq. ft.	33 lbs.	20 (31.80 sq. ft.)	710 lbs.
Large	35 x 9.75 x 2" x H	2.37 sq. ft.	52 lbs.	20 (47.40 sq. ft.)	1,090 lbs.

Dimensions shown are nominal. Pallet square footage is accurate, layers and bands square footages have been rounded to nearest whole number.

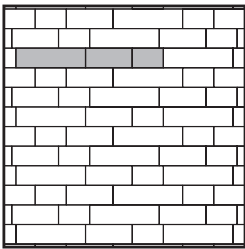

Pattern 1
Small = 20.9%
Medium = 31.6%
Large = 47.4%

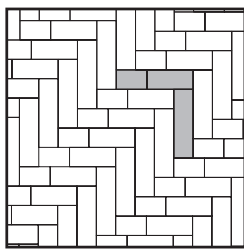

Pattern 2
Small = 20.9%
Medium = 31.6%
Large = 47.4%

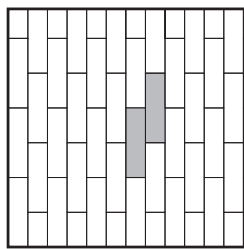

Pattern 3
Large = 100%

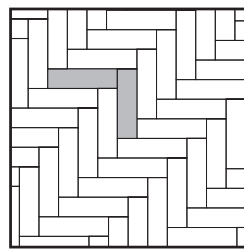

Pattern 4
Large = 100%



Barn Plank Garden Wall

Silver Creek Stoneworks

- Deep splits and detailed grain on five sides
- Smooth radius, 90° corners all sides
- Matching landscape tiles and step
- **Matching Fire Pit Kit on page 49**

Colors

- Mahogany
- Weathered Gray

Barn Plank Garden Wall is manufactured with a surface applied protectant to help resist the harmful effects of time, Mother Nature, acid rain and stains.

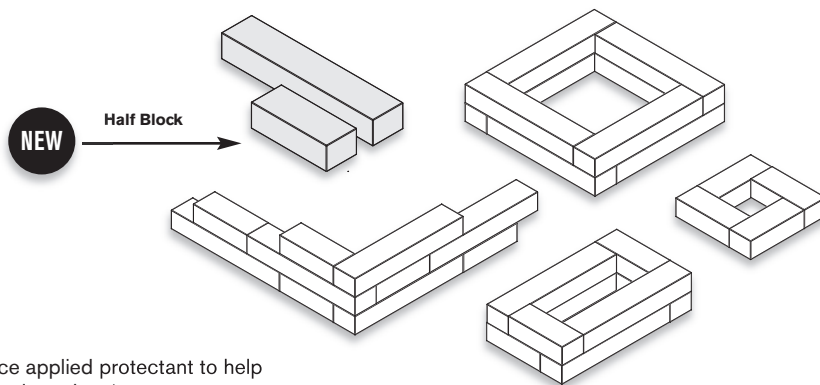

Name	Dimensions	Area (ea.)	Weight (ea.)	Units/pallet	Weight/pallet
Barn Plank Garden Wall	40 x 8 x 6" H	1.66 sq. ft.	162 lbs.	16 (26.56 sq. ft.)	2,650 lbs.
Half Block (NEW)	20 x 8 x 6" H	0.83 sq. ft.	81 lbs.	TBD	TBD

Slate Landscape Tiles

Silver Creek Stoneworks

Features

- Four sizes with 23 unique faces plus coping
- Strong and durable 10,000 psi concrete
- Detailed slate top, chiseled sides
- No spacers, easily gapped
- Unique 24" x 36" slab

Colors

- Bluestone
- Cream
- Fond du Lac
- Western Buff (discontinued)

Notes

- Partial pallet quantities available.
- Pallets CANNOT be double stacked.

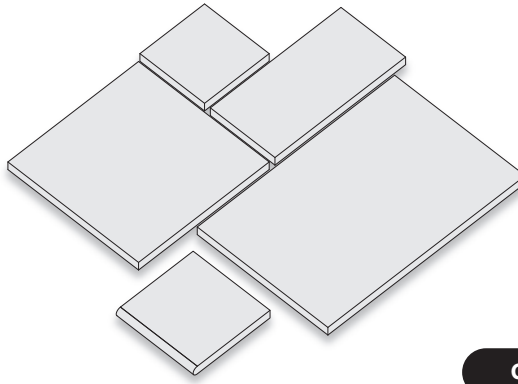

Gap tiles a minimum of 1/4"

Size/Name	Dimensions	Area (ea.)	Weight (ea.)	Units/pallet	Weight/pallet
Small Sq.	12 x 12 x 1.5" H	1 sq. ft.	19 lbs.	48 (48 sq. ft.)	938 lbs.
Rectangle	24 x 12 x 1.5" H	2 sq. ft.	38 lbs.	24 (48 sq. ft.)	962 lbs.
Large Sq.	24 x 24 x 1.5" H	4 sq. ft.	77 lbs.	24 (96 sq. ft.)	1,898 lbs.
XL	24 x 36 x 1.5" H	6 sq. ft.	106 lbs.	16 (96 sq. ft.)	1,746 lbs.
Bullnose	14 x 14 x 1.5" H	1.36 sq. ft.	25 lbs.	24 (32.66 sq. ft.)	650 lbs.

Dimensions shown are nominal. Pallet square footage is accurate, layers and bands square footages have been rounded to nearest whole number.

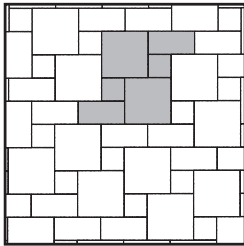

Pattern 1

Small sq. = 14%
Rectangle = 29%
Lg. Sq. = 57%

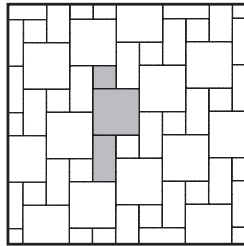

Pattern 2

Small sq. = 14%
Rectangle = 29%
Lg. Sq. = 57%

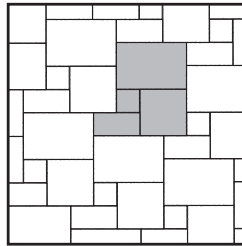

Pattern 3

Small sq. = 7.69%
Rectangle = 15.39%
Lg. Sq. = 30.77%
XL = 46.15%

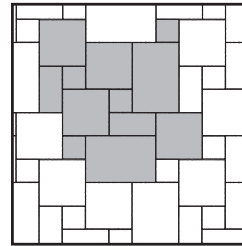

Pattern 4

Small sq. = 11.1%
Rectangle = 11.1%
Lg. Sq. = 44.4%
XL = 33.3%

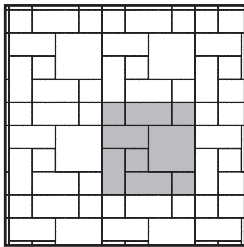

Pattern 5

Small sq. = 25%
Rectangle = 50%
Lg. Sq. = 25%

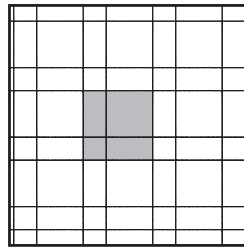

Pattern 6

Small sq. = 11.2%
Rectangle = 44.4%
Lg. Sq. = 44.4%



IMPORTANT SILVER CREEK INSTALLATION NOTES:



- Gap tiles 1/4" to aid leveling and aesthetics
- Compact with a roller packer or buffer pad to prevent scuffing
- Pull from multiple pallets and rotate tiles to enhance random appearance

Antique Travertine Landscape Tiles

Silver Creek Stoneworks

Features

- Three sizes w/eighteen unique faces
- Detailed travertine top and sides, smooth honed surface
- For paths, patios, pools and overlays
- Matching step block, garden wall, coping and fire pit kit
- Strong and durable 10,000 psi concrete

Partial pallet quantities available, pallets CANNOT be double stacked.

Colors

- Ivory
- Natural

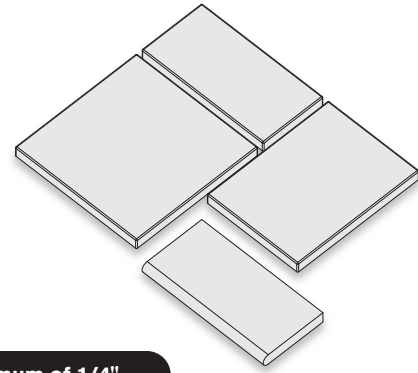

Gap tiles a minimum of 1/4"

Size/Name	Dimensions	Area (ea.)	Weight (ea.)	Units/pallet	Weight/pallet
Small	12 x 24 x 2" H	2 sq. ft.	46 lbs.	20 (40 sq. ft.)	970 lbs.
Medium	18 x 24 x 2" H	3 sq. ft.	70 lbs.	18 (54 sq. ft.)	1,310 lbs.
Large	24 x 24 x 2" H	4 sq. ft.	88 lbs.	18 (72 sq. ft.)	1,634 lbs.
Bullnose	24 x 12 x 2" H	2 sq. ft.	43 lbs.	20 (40 sq. ft.)	910 lbs.

Dimensions shown are nominal. Pallet square footage is accurate, layers and bands square footages have been rounded to nearest whole number.

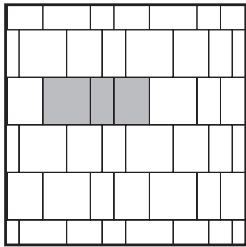

Pattern 1
Small = 22.26%
Medium = 33.33%
Large = 44.4%

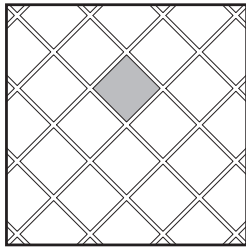

Pattern 2
Large = 100%

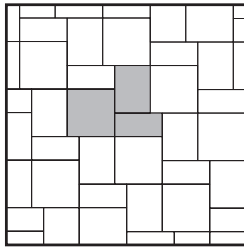

Pattern 3
Small = 22.26%
Medium = 33.33%
Large = 44.4%

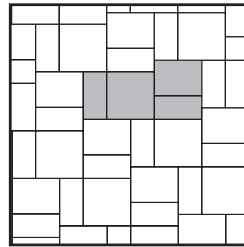

Pattern 4
Small = 36.2%
Medium = 27.3%
Large = 36.5%

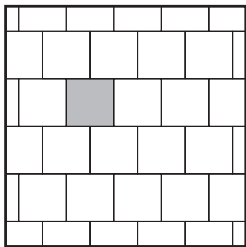

Pattern 5
Large = 100%

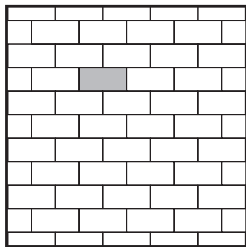

Pattern 6
Small = 100%



Antique Travertine Garden Wall

Silver Creek Stoneworks

- Soft radius all sides
- Builds a 8'-10.5" radius wall radius without cutting
- Matching landscape tiles and step
- **Matching Travertine Fire Pit Kit (pg. 49)**

Colors

- Ivory
- Natural

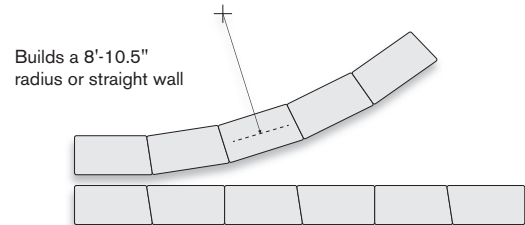
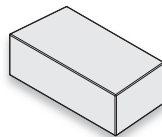

Travertine Garden Wall	Area (ea.)	Weight (ea.)	Units/pallet	Weight/pallet
18 x 9 x 6" H (front)/ 16.5 x 9 x 6" H (back)	.75 sq. ft.	80 lbs.	20 (15 sq. ft.)	1,650 lbs.

Minnetonka and Barrington Pavers/Slabs 6cm

Interlock Concrete Products

Features

- Three-piece, one-pallet systems
- Chamfered/irregular edge
- Auto spacers, 1/8" joint
- Suitable for paths, patios, pool decks
- 6 x 12" Accent pavers
- Available by pallet or layer



All colors protected with KolorLast



Colors

- Antique Brown w/KolorLast
- Beechwood w/KolorLast
- Bluestone w/KolorLast
- Cascade w/KolorLast
- Santa Fe w/KolorLast

6 x 12 Colors (Separate Pallets)

- Brown w/KolorLast
- Buff w/KolorLast
- Onyx w/KolorLast

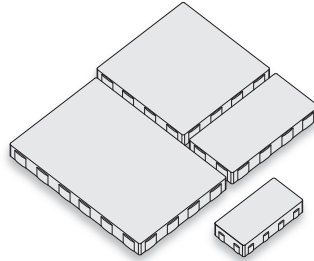

Barrington = Smooth Top

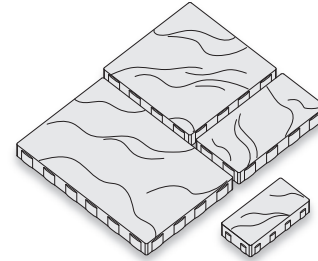

Minnetonka = Slate Top

Size/Name	Dimensions	Area (ea.)	Weight (ea.)	Units/layer	Area/layer	Layers	Units/pallet	Weight/pallet
Small	8 x 16 x 2.375" H	0.89 sq. ft.	24.5 lbs.	2	-	-	20	
Medium	16 x 16 x 2.375" H	1.78 sq. ft.	49 lbs.	2	10.2 sq. ft.	10	20 (102 sq. ft.)	3,000 lbs.
Large	16 x 24 x 2.375" H	2.67 sq. ft.	73.5 lbs.	2	-	-	20	

6 x 12	5.75 x 11.5 x 2.375" H	0.46 sq. ft.	13 lbs.	21	9.66 sq. ft.	10	210 (97 sq. ft.)	2,780 lbs
--------	------------------------	--------------	---------	----	--------------	----	------------------	-----------

Dimensions shown are nominal. Pallet square footage is accurate, layers and bands square footages have been rounded to nearest whole number.

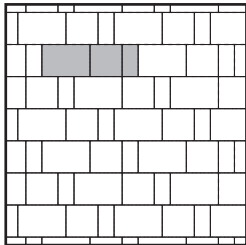

Pattern 1
Small = 16.6%
Medium = 33.33%
Large = 50.7%

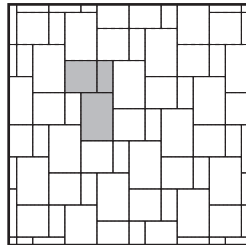

Pattern 2
Small = 16.6%
Medium = 33.33%
Large = 50.7%

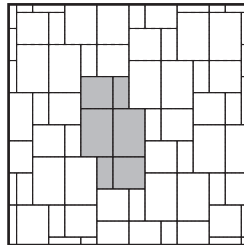

Pattern 3
Small = 16.6%
Medium = 33.33%
Large = 50.7%

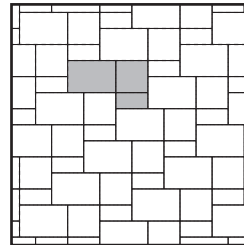

Pattern 4
Small = 16.6%
Medium = 33.33%
Large = 50.7%

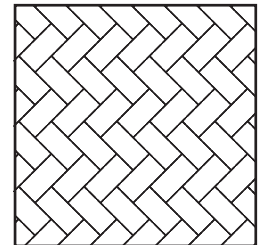

Herringbone
6 x 12 = 100%

KolorLast protected pavers live up to the damaging effects of time, Mother Nature and decades of use and abuse.

KolorLast Protected pavers are:

- Fade Resistant
- Stain Resistant
- Acid Rain Resistant
- Salt Resistant
- Spalling Resistant
- Inhibits Efflo and Poly Haze



KolorLast
Hardscape Protectant

Mezzano and Serano Pavers 6cm

Interlock Concrete Products



Features

- Three-piece, one pallet system
- Chamfered/irregular edge
- Auto spacers, 1/8" joint
- Suitable for vehicular applications
- 6 x 12" Accent pavers
- Available by pallet or layer



All colors protected with KolorLast

Colors

- Antique Brown w/KolorLast
- Beechwood w/KolorLast
- Bluestone w/KolorLast
- Cascade w/KolorLast
- Santa Fe w/KolorLast

6 x 12 Colors (Separate Pallets)

- Brown w/KolorLast
- Buff w/KolorLast
- Onyx w/KolorLast

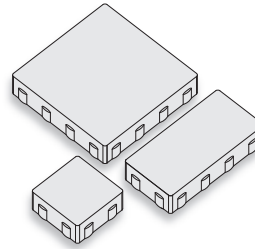

Serano = Smooth Top

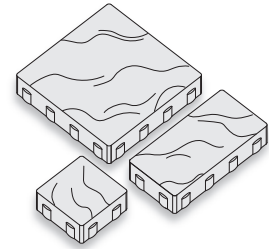

Mezzano = Slate Top

Size/Name	Dimensions	Area (ea.)	Weight (ea.)	Units/layer	Area/layer	Layers	Units/pallet	Weight/pallet
Small	5.75 x 5.75 x 2.375" H	0.23 sq. ft.	6 lbs.	6	1.38 sq. ft.	-	60	
Medium	5.75 x 11.5 x 2.375" H	0.46 sq. ft.	13 lbs.	6	2.76 sq. ft.	10	60 (97 sq. ft.)	2,685 lbs.
Large	11.5 x 11.5 x 2.375" H	0.92 sq. ft.	25 lbs.	6	5.52 sq. ft.	-	60	
6 x 12	5.75 x 11.5 x 2.375" H	0.46 sq. ft.	13 lbs.	21	9.66 sq. ft.	10	210 (97 sq. ft.)	2,780 lbs.

Dimensions shown are nominal. Pallet square footage is accurate, layers and bands square footages have been rounded to nearest whole number.

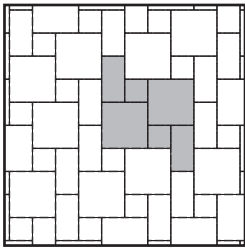

Pattern 1
Small = 14%
Medium = 29%
Large = 57%

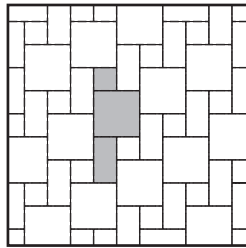

Pattern 2
Small = 14%
Medium = 29%
Large = 57%

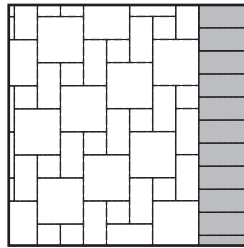

Pattern 2
Soldier Course Border

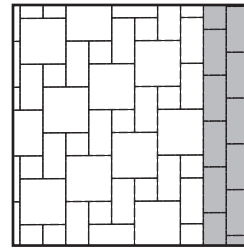

Pattern 2
Double Sailor Course Border

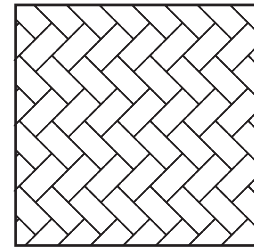

Herringbone
6 x 12 = 100%

Build fast and efficiently by using open graded base material and large format pavers.

Open graded paver base construction is wet weather friendly, costs less than conventional base and can save as much as 35 labor hours per week. In six months, you could gain as much as 840 labor hours.

Choose large format pavers and install more jobs. See the time study comparison at: www.rochesterpcp.com/efficiency

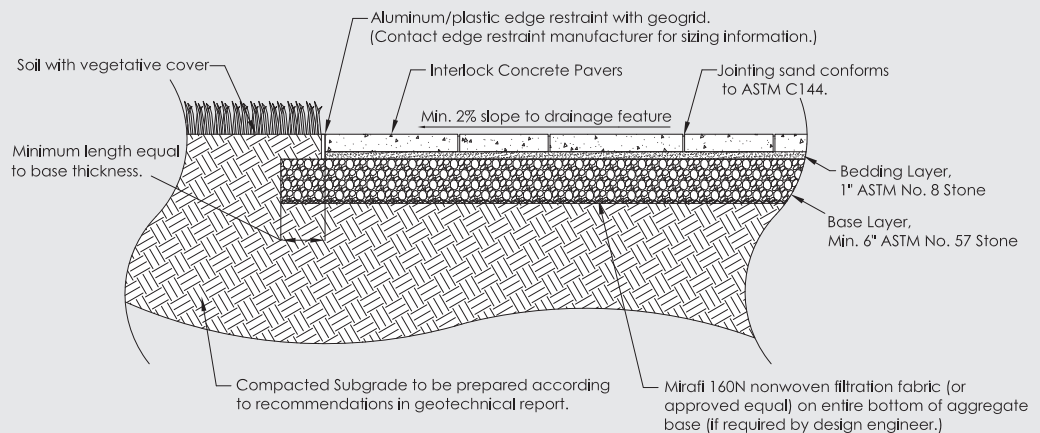

Design Notes:

1. Cross section as shown is suitable for sidewalks, residential driveways, and patios.
2. Depth of aggregate base subject to site specific conditions such as soil conditions, groundwater levels, climate conditions, etc. Contact your local sales representative.
3. Depending on the permeability of subgrade soils, drain pipes should be placed within the aggregate base. Drainage needs should be verified with the geotechnical engineer. Drain pipes must be able to daylight via gravity flow to the surface or be connected to a catch basin.
4. Jointing sand that conforms to ASTM C144 may be used in pedestrian and residential driveway applications. Contact your local sales representative.

Broadmour Pavers 6cm

Interlock Concrete Products

Features

- Smooth top, chamfered edges
- Auto spacers, narrow joint
- Lays quickly, patterned or random
- 24" x 24" x 2.375" H
- Available by pallet or layer

Colors

- Cascade
- Natural
- Onyx w/Kolorlast 6cm only

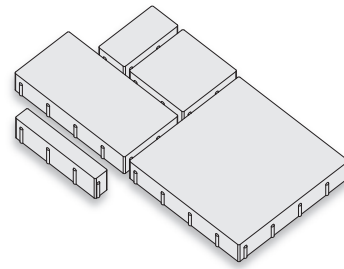

Broadmour (6cm)	Size	Face Area	Weight	Units/Layer	Layer	Layers	Units/Pallet	Pallet Weight
Small	6 x 12 x 2.375" H	0.5 sq. ft.	15.65 lbs.	24	12 sq. ft.	6	144 (72 sq. ft.)	2,304 lbs.
Medium	12 x 12 x 2.375" H	1.0 sq. ft.	30.4 lbs.	9	9 sq. ft.	10	90 (90 sq. ft.)	2,790 lbs.
Large	24 x 12 x 2.375" H	2 sq. ft.	59 lbs.	6	12 sq. ft.	8	48 (96 sq. ft.)	2,880 lbs.
Large Sq.	24 x 24 x 2.375" H	4 sq. ft.	113.5 lbs.	2	8 sq. ft.	10	20 (80 sq. ft.)	2,320 lbs.
Plank (10cm)	18 x 3 x 4" H	0.36 sq. ft.	17.3 lbs.	22	7.92 sq. ft.	6	132 (47.5 sq. ft.)	2,130 lbs.

Broadmour Plank is high flow rate permeable. Not suitable for vehicular.

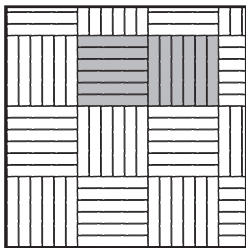

Pattern 1
Plank = 100%

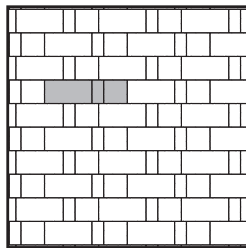

Pattern 2
Small = 14.3%
Medium = 28.57%
Large = 57.14%

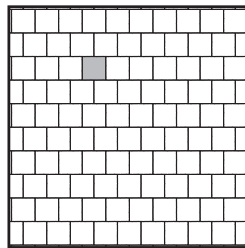

Pattern 3
Medium = 100%

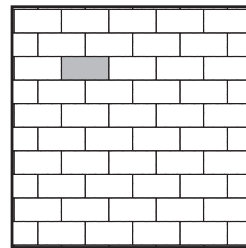

Pattern 4
Large = 100%

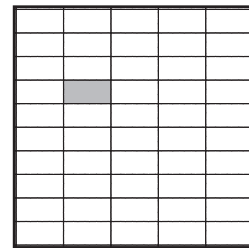

Pattern 5
Large = 100%

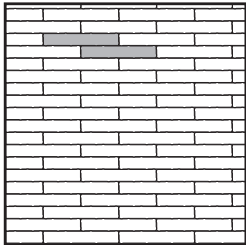

Pattern 6
Plank = 100%

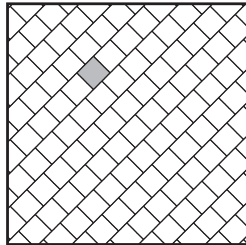

Pattern 7
Squares = 100%

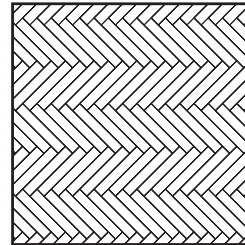

Herringbone
Plank = 100%



Broadmour Plank is a high-flow-rate, eco-friendly permeable paver.

Broadmour Pavers 10cm (special order)

10cm Broadmour pavers can be made in any color with or without KolorLast. Minimum quantity required, customer must take entire production run. Returns not allowed.

- Suitable for heavy vehicular applications

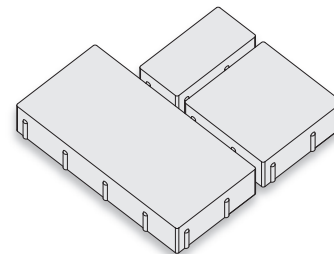

Broadmour XXL (10cm)

Small	6 x 12 x 4" H	0.5 sq. ft.	22.93 lbs.	15	7.17 sq. ft.	6	90 (43 sq. ft.)	2,050 lbs.
Medium	12 x 12 x 4" H	1.0 sq. ft.	46.22 lbs.	9	8.67 sq. ft.	6	54 (52 sq. ft.)	2,500 lbs.
Large	24 x 12 x 4" H	2 sq. ft.	92 lbs.	4	7.67 sq. ft.	6	24 (46 sq. ft.)	2,270 lbs.

Dimensions shown are nominal. Pallet square footage is accurate, layers and bands square footages have been rounded to nearest whole number.

Colonial Paver 6cm

Interlock Concrete Products



Features

- Four-piece system
- Dimpled top, radius edge
- Auto spacers, 1/16" joint
- Suitable for vehicular applications
- 6cm rectangle and 3/4 square available in Brown, Buff, Onyx
- Circle kits available
- Available by pallet or band

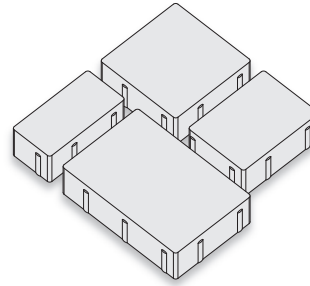

Colors

- Antique Copper
- Beechwood
- Carmel (discontinued)
- Moonlight Gray

Accent Colors (3/4 sq. and rectangle)

- Brown*
- Buff*
- Onyx* w/Kolorlast

Name	Size	Face Area	Weight	Units/Band	Bands/Pallet	Units/Pallet	Pallet Weight
Half Square	6.30 x 3.15 x 2.375" H	0.14 sq. ft.	3 lbs.	50 (6.86 sq. ft.)	7	350 (48 sq. ft.)	1,300 lbs.
3/4 Square*	6.30 x 4.65 x 2.375" H	0.20 sq. ft.	6 lbs.	56 (11.4 sq. ft.)	7	392 (80 sq. ft.)	2,180 lbs.
Square	6.30 x 6.30 x 2.375" H	0.28 sq. ft.	7 lbs.	50 (14 sq. ft.)	7	350 (98 sq. ft.)	2,690 lbs.
Rectangle*	6.30 x 9.45 x 2.375" H	0.41 sq. ft.	12 lbs.	45 (18.4 sq. ft.)	5	225 (92 sq. ft.)	2,650 lbs.

Dimensions shown are nominal. Pallet square footage is accurate, layers and bands square footages have been rounded to nearest whole number.

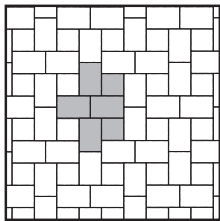

Pattern 1

Square = 25%
Rectangle = 75%

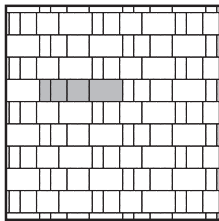

Pattern 2

Half square = 13.37%
3/4 square = 19.75%
Square = 26.75%
Rectangle = 40.13%

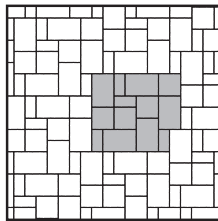

Pattern 3

Half square = 14.81%
Square = 29.63%
Rectangle = 55.56%

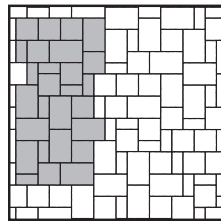

Pattern 4

Half square = 14.55%
Square = 36.36%
Rectangle = 49.09%

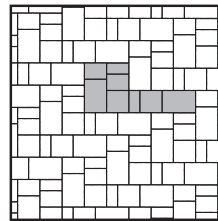

Pattern 5

Half square = 13.37%
3/4 square = 19.75%
Square = 26.75%
Rectangle = 40.13%

Colonial Paver 8cm (special order)

Interlock Concrete Products

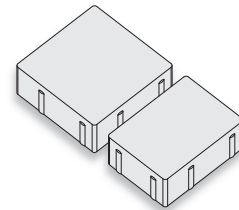

Features

- Auto spacers, 1/16" joint
- Dimpled top, radius edge
- Suitable for vehicular applications
- Available by pallet or band

8cm Colonial pavers can be made in any color with or without KolorLast. Set-up fee and minimum quantity required, customer must take entire production run. Returns not allowed.

Name	Size	Face Area	Weight	Units/Band	Bands/Pallet	Unit/Pallet	Pallet Weight
Square	6.30 x 6.30 x 3.125" H	0.28 sq. ft.	10 lbs.	35	7 (9.71 sq. ft.)	245 (68 sq. ft.)	2,560 lbs.
Rectangle	6.30 x 9.45 x 3.125" H	0.41 sq. ft.	16 lbs.	35	5 (14.4 sq. ft.)	175 (72 sq. ft.)	2,750 lbs.

Dimensions shown are nominal. Pallet square footage is accurate, layers and bands square footages have been rounded to nearest whole number.

Colonial Circle 6cm

Interlock Concrete Products

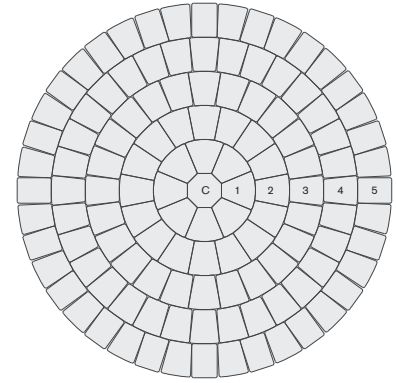

Features

- Auto spacers, 1/16" joint
- Expand to any size
- Available by pallet or band/layer
- Starter circle kit creates a 2 course, 2.64' dia. circle
- Six starter kits/pallet

Note: 13.25 ft. dia. circle* (12 courses) requires starter circle kit, plus one pallet of large circle (wedges), plus one pallet of 3/4 squares.

Colors

- Antique Copper
- Moonlight Gray
- Beechwood

Pallet	Size	Weight	Units	Layers-Bands	Units/Pallet	Pallet Weight
Starter Circle Kit**	(Center + course 1 & 2)	Mixed	30/layer	6 layers/pallet	180 (36 sq. ft.)	1,060 lbs.
Large Circle (wedges)	6.3 x 5.2 x 2.375" H	6 lbs. (0.23 sq. ft.)	40/layer	7 layers/pallet	280 (56 sq. ft.)	1,550 lbs.
3/4 Square	4.65 x 6.30 x 2.375" H	6.66 lbs. (0.20 sq. ft.)	56/band	7 bands/pallet	392 (80 sq. ft.)	2,180 lbs.

**Starter Circle pallet includes 6 starter circle kits

Course	Diameter	Area	Starter Kit*	Large Circle Pallet			3/4 Squares	
				Pallet	Units (per course)	Layers (required)	Pallets	Bands
Center	0.53 ft.	0.22 sq. ft.	1					
1*	1.58 ft.	1.97 sq. ft.	1					
2*	2.64 ft.	5.48 sq. ft.	1					
3	3.70 ft.	10.75 sq. ft.	1		26	1		
4	4.76 ft.	17.78 sq. ft.	1		34	2		
5	5.82 ft.	26.57 sq. ft.	1		21	2		1
6	6.88 ft.	37.12 sq. ft.	1		26	3		1
7	7.93 ft.	49.43 sq. ft.	1		30	4		2
8	8.99 ft.	63.50 sq. ft.	1		34	5		2
9	10.05 ft.	79.33 sq. ft.	1		38	6		3
10	11.11 ft.	96.91 sq. ft.	1	1	42			4
11	12.17 ft.	116.26 sq. ft.	1	1				5
12*	13.25 ft.	137.37 sq. ft.	1	1			1	
13	14.28 ft.	160.23 sq. ft.	1	1			1	2
14	15.34 ft.	184.86 sq. ft.	1	1			1	4
15	16.40 ft.	211.24 sq. ft.	1	1			1	6
16	17.46 ft.	239.38 sq. ft.	1	1			2	2
17	18.52 ft.	269.29 sq. ft.	1	1			2	4
18	19.58 ft.	300.95 sq. ft.	1	1			3	
19	20.63 ft.	334.37 sq. ft.	1	1			3	3
20	21.69 ft.	369.55 sq. ft.	1	1			3	6

Example: To build a 20.63' dia. circle, you'll need (1) starter kit + (1) large circle pallet + (3) 3/4 sq. pallets + (3) 3/4 sq. bands.



American Brick Paver 6cm

Interlock Concrete Products



Features

- Ideal for borders, accents and insets
- Smooth top, subtle texture surface
- Radius edges and corners
- No spacers, zero joint
- Available by layer



All colors protected with KolorLast

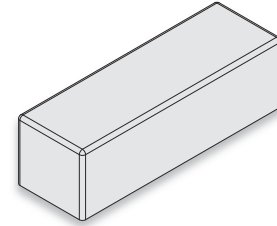

Colors

- Tuscan Red w/KolorLast
- Brown w/KolorLast
- Buff w/KolorLast
- Onyx w/KolorLast

Size	Face Area	Weight	Units/Layer	Layer	Layers	Units/Pallet	Pallet Weight
8 x 2.5 x 2.375" H	0.14 sq. ft.	3 lbs.	60	8.4 sq. ft.	10	600 (84 sq. ft.)	1,800 lbs.

Dimensions shown are nominal. Pallet square footage is accurate, layers and bands square footages have been rounded to nearest whole number

Lamont Paver 6cm

Interlock Concrete Products



Features

- Four-piece, smooth surface, tumbled system
- No auto spacers, zero joint
- Suitable for vehicular applications
- Extremely versatile – endless designs
- 4" x 8" and 6" x 8" available in Brown, Onyx or Desert Buff for accenting
- Circle kits available
- Available by pallet or band

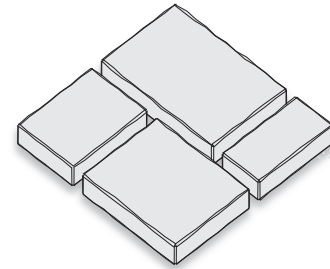

Colors

- Antique Brown
- Beechwood
- Sierra Gray
- Santa Fe



4 x 8 and 6 x 8 Colors

- Brown
- Desert Buff
- Onyx

Name	Size	Face Area	Weight	Units/Band	Bands/Pallet	Units/Pallet	Pallet Weight
4 x 8	4.13 x 8.25 x 2.375" H	0.24 sq. ft.	7 lbs.	80 (19.2 sq. ft.)	5	400 (96 sq. ft.)	2,625 lbs.
6 x 8	6.1875 x 8.25 x 2.375" H	0.35 sq. ft.	10 lbs.	50 (17.8 sq. ft.)	5	250 (89 sq. ft.)	2,450 lbs.
10 x 8	10.3 x 8.25 x 2.375" H	0.59 sq. ft.	17 lbs.	40 (23.75 sq. ft.)	4	160 (95 sq. ft.)	2,710 lbs.
12 x 8	12.375 x 8.25 x 2.375" H	0.71 sq. ft.	21 lbs.	40 (28.5 sq. ft.)	4	160 (114 sq. ft.)	3,170 lbs.

Dimensions shown are nominal. Pallet square footage is accurate, layers and bands square footages have been rounded to nearest whole number.

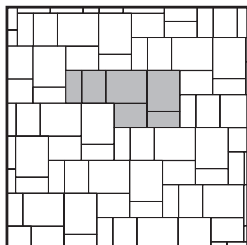

Pattern 1
4 x 8 = 20%
6 x 8 = 30%
10 x 8 = 50%

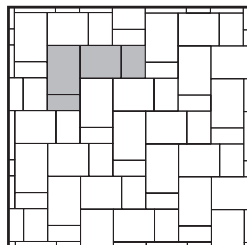

Pattern 2
4 x 8 = 12%
6 x 8 = 19%
10 x 8 = 31%
12 x 8 = 38%

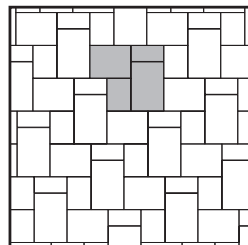

Pattern 3
4 x 8 = 12%
6 x 8 = 19%
10 x 8 = 31%
12 x 8 = 38%

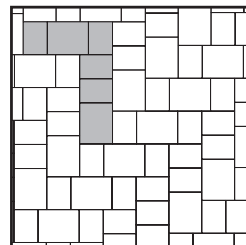

Pattern 4
6 x 8 = 45%
10 x 8 = 55%

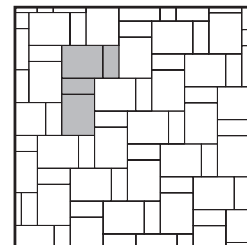

Pattern 5
4 x 8 = 29%
10 x 8 = 71%

Lamont Circle 6cm

Interlock Concrete Products

Features

- All on one pallet
- 10.33 ft. diameter circle
- No auto spacers, zero joint

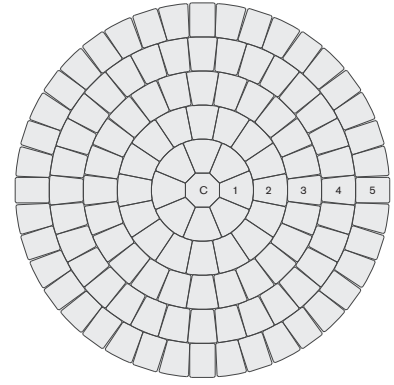

Colors

- Beechwood
- Santa Fe
- Sierra Gray

Sold as full pallets only. Circle Pallet makes 10.33 ft. diameter.

Starter Kit Pallet	Size	Face Area	Weight Ea.	Units/Pallet	Pallet	Pallet Weight
Center Piece	8.26 x 8.26 x 2.375" H	0.47 sq. ft.	13 lbs.	9	-	-
Small Circle	9.39 x 8.26 x 2.375" H	0.54 sq. ft.	15 lbs.	9	-	-
Middle Circle	7.97 x 8.26 x 2.375" H	0.59 sq. ft.	17 lbs.	18	89 sq. ft.	2,520 lbs.
Large Circle	7.21 x 8.26 x 2.375" H	0.41 sq. ft.	12 lbs.	135	-	-
6 x 8	6.187 x 8.25 x 2.375" H	0.35 sq. ft.	10 lbs.	81	-	-

Course No.	Outside Dia.	Outside Dia. (ft.)	Area (sq. ft.)	Circle Pallet					6 x 8 Units	6 x 8 Pallets	6 x 8 Bands
				Center	Small	Middle	Large	6 x 8			
Center	8.26"	0.69	0.37	1	0	0	0	0			
1	24.76"	2.06	3.34	0	8	0	0	0			
2	41.26"	3.44	9.29	0	0	16	0	0			
3	57.76"	4.81	18.20	0	0	0	24	0			
4	74.26"	6.19	30.08	0	0	0	32	0			
5	90.76"	7.56	44.93	0	0	0	20	20			
6	107.26"	8.94	62.75	0	0	0	24	24			
7	123.76"	10.33	83.54	0	0	0	28	29			
8	140.11"	11.68	107.07			1			72	2	
9	156.46"	13.04	133.52			1			80	3	
10	172.81"	14.40	162.88			1			88	1	
11	189.16"	15.76	195.16			1			97	1	
12	205.51"	17.13	230.35			1			105	1	
13	221.86"	18.49	268.46			1			113	2	
14	238.21"	19.85	309.49			1			122	2	
15*	254.56"	21.21	353.43			1			130	3	

*Example: To build a 21.2' dia. circle, you'll need (1) starter kit pallet + (3) 6 x 8 pallets + (2) 6 x 8 bands

Dimensions shown are nominal. Pallet square footage is accurate, layers and bands square footages have been rounded to nearest whole number.

IMPORTANT PAVER INSTALLATION NOTES:



Pavers with embossed surfaces are more susceptible to scuff marks from plate compactors. Always use a roller compactor or a protective mat between the plate and paver surface when compacting.

Cobble Stone Paver 8cm

Interlock Concrete Products



Features

- Four-piece, one-pallet system
- Designed for driveways, pathways and accenting applications
- Subtle texture top with soft edge detail
- Lays in a running bond
- Large auto-spacer; high flow rate eco/permeable
- Available by pallet or layer

Colors

- Beechwood
- Moonlight Gray
- Onyx w/KolorLast

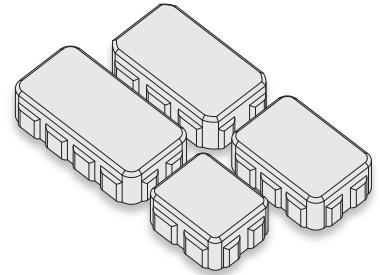

Size	Face Area	Units/Layer	Layer	Layers	Units/Pallet	Pallet Weight
7.125 x 5.875 x 3.125" H	0.29 sq. ft.	8	(Sold as sets)			
8.625 x 5.875 x 3.125" H	0.36 sq. ft.	8	12.33 sq. ft.	6	192 (74 sq. ft.)	2,575 lb
10.375 x 5.875 x 3.125" H	0.42 sq. ft.	8				
11.875 x 5.875 x 3.125" H	0.48 sq. ft.	8				

Dimensions shown are nominal. Pallet square footage is accurate, layers and bands square footages have been rounded to nearest whole number.

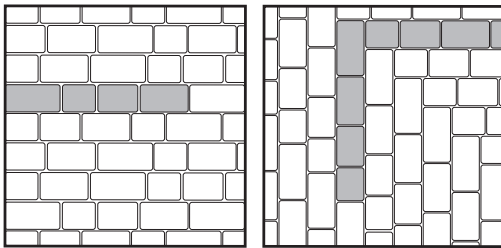

Running Bond Patterns



Flagstone Paver 6cm

Interlock Concrete Products



Features

- One shape, six unique slate embossed faces
- 2.375" H, 1.58 sq. ft. each
- Deep/wide false joint
- Simple running bond installation
- Suitable for pedestrian applications
- Available by pallet or layer
- Use a buffer pad between the plate compactor and surface to prevent scuffing

Colors

- Antique Brown
- Sierra Gray
- Santa Fe

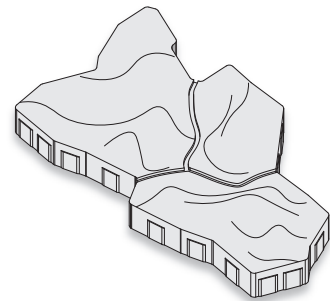

Size	Face Area	Weight	Units/Layer	Layer	Layers	Units/Pallet	Pallet Weight
Six Faces	1.58 sq. ft.	45.8 lbs.	6	9.5	10	60 (95 sq. ft.)	2,806 lbs.

Dimensions shown are nominal. Pallet square footage is accurate, layers and bands square footages have been rounded to nearest whole number.



Holland Pavers 6cm & 8cm

Interlock Concrete Products



Features

- Larger than typical Hollands (4.25" W x 8.5" H)
- Smooth top, beveled edge
- Small auto-spacer
- For patios, paths, pools and drives
- Endless design opportunities
- Available in 6cm and 8cm heights
- Available by pallet or band

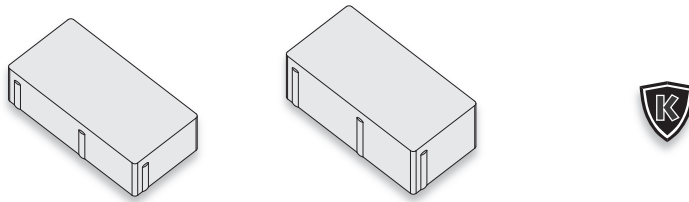

6cm Colors

- Antique Copper
- Beechwood
- Brown
- Buff
- Carmel (discontinued)
- Moonlight Gray
- Onyx w/KolorLast
- Rosewood

(8cm is special order)

8cm Holland pavers can be made in any color with or without KolorLast. Minimum quantity required, customer must take entire production run. Returns not allowed.

Size	Face Area	Weight	Units/Bands	Bands	Band	Units/Pallet	Pallet
8.5 x 4.25 x 2.375" H	0.24 sq. ft.	7 lbs.	80	5	19.6 sq. ft.	400 (98 sq. ft.)	2,785 lbs.
8.5 x 4.25 x 3.125" H	0.24 sq. ft.	9 lbs.	56	5	13.8 sq. ft.	280 (69 sq. ft.)	2,560 lbs..

Dimensions shown are nominal. Pallet square footage is accurate, layers and bands square footages have been rounded to nearest whole number.

Holland-Eco Paver 8cm

Interlock Concrete Products

Features

- 5" x 10" H and 5" x 5" x 3.125" H (can be ordered without squares)
- Large auto-spacer; high flow rate eco/permeable
- Ideal for vehicular applications
- Machine layable
- Available by pallet

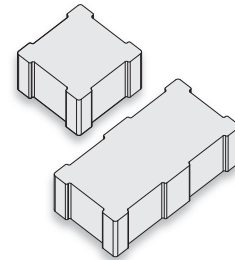

Colors

- Beechwood
- Carmel

Size	Face Area	Weight	Units/Layer	Layers	Units/Pallet	Pallet Weight
4.875 x 9.75 x 3.125" H	0.34 sq. ft.	13 lbs.	28 (10.6 sq. ft.)	8	224 (84.7 sq. ft.)	3,050 lbs.
4.875 x 4.875 x 3.125" H	0.17 sq. ft.	6.54 lbs.	7	-	-	-

Dimensions shown are nominal. Pallet square footage is accurate, layers and bands square footages have been rounded to nearest whole number.

Turfstone-Eco Paver 8cm (special order)

Interlock Concrete Products

Features

- High flow rate permeable (Voids = 0.25 cu. ft. per unit)
- Special order – set-up fee and minimum quantities apply

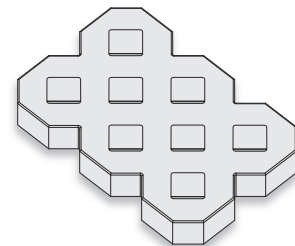

Turfstone-Eco paver can be made in any color. Minimum quantity required, customer must take entire production run. Returns not allowed.

Size	Face Area	Weight	Units/Band	Band	Bands	Units/Pallet	Pallet Weight
23.63 x 15.75 x 3.125" H	2.58 sq. ft.	64.5 lbs.	16	41 sq. ft.	2	32 (82 sq. ft.)	1,940 lbs.

Dimensions shown are nominal. Pallet square footage is accurate, layers and bands square footages have been rounded to nearest whole number.

Vintage 6 Retaining/Freestanding Wall

Rockwood Retaining Walls

Features

- Three-piece system, all sizes on one pallet
- Split-faced, tumbled vertical wall system
- Builds straight or 8' radius without cutting, freestanding or retaining walls
- End blocks are split on three sides, corner/pillar block split on two sides

Colors

- Beechwood
- Bluestone
- Cascade (Spring 2020)
- Santa Fe
- Desert Buff (discontinued)

ROCKWOOD
RETAINING WALLS
A better way.

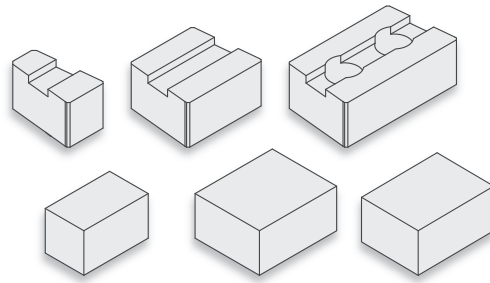

Vintage 6	Size	Face Area	Weight	Pallets	Weight
Small	6 x 10 x 6" H	0.25 sq. ft.			
Medium (Sold as sets, full pallets only)	12 x 10 x 6" H	0.50 sq. ft.	137.5 lbs.	20 sets (30 sq. ft.)	2,800 lbs.
Large	18 x 10 x 6" H	0.75 sq. ft.			
Small End block	6 x 10 x 6" H	0.42 sq. ft.			
Large End block (Sold in sets)	12 x 10 x 6" H	0.83 sq. ft.	81.50 lbs.	8 sets (10 sq. ft.)	702 lbs.
Corner/Pillar Block (Full pallets only)	12 x 9 x 6" H	0.50 sq. ft.	48 lbs.	30 (15 sq. ft.)	1,490 lbs.

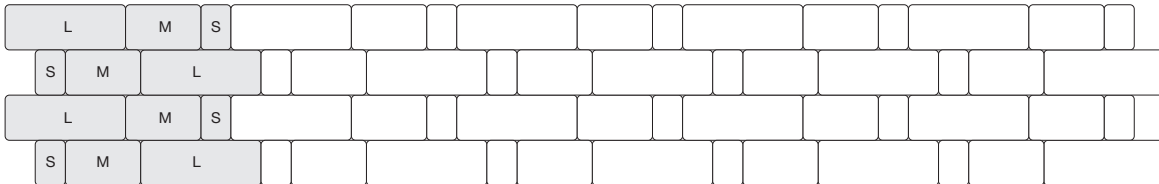

Concave 8 ft. Radius Wall Pattern (small side)

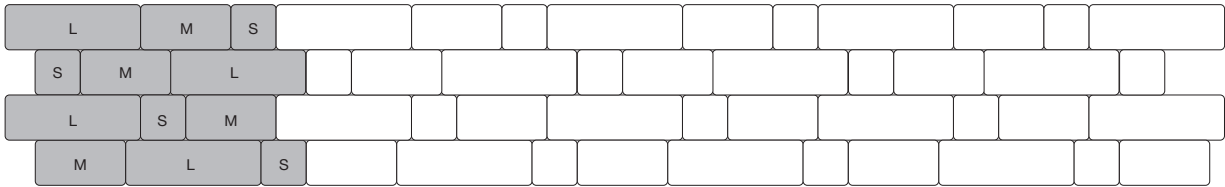

Convex Wall Pattern (large side)

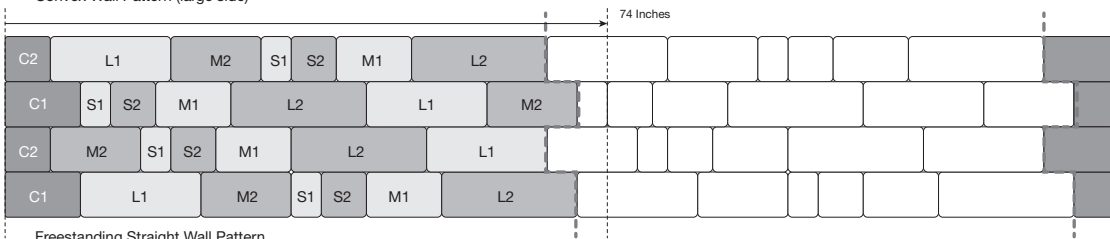

Freestanding Straight Wall Pattern

Riverland Wall

Rockwood Retaining Walls

Features

- Three-piece, tumbled, one pallet system
- Builds 7'-8" radius without cutting
- Cap with 3" or Chiseled Cap
- Available by pallet

Colors

- Beechwood
- Bluestone
- Cascade (**NEW**)
- Santa Fe
- Onyx
- Desert (discontinued except kits)

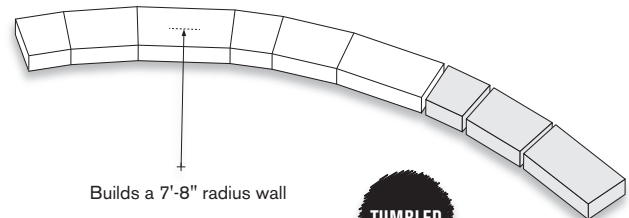

Builds a 7'-8" radius wall



Block	Size	Face Area	Weight	Layers	Sets/Layer	Sets/Pallet	Pallet Weight
Small	8 x 8 x 4" H	(3 piece sets)					
Medium	12 x 8 x 4" H	1 sq. ft.	90 lbs.	6	5	30 (30 sq. ft.)	2,750 lbs.
Large	16 x 8 x 4" H						

Lakeland Wall

Rockwood Retaining Walls

Features

- Tumbled, 3-piece, two pallet system
- Extremely versatile system builds vertical, freestanding retaining walls and outdoor living features
- Builds straight walls
- Cap with 3" or Chiseled Cap
- Available by pallet

Colors

- Beechwood
- Bluestone
- Cascade (**NEW**)
- Santa Fe
- Onyx (available non-tumbled, large only)
- Desert (discontinued except kits)

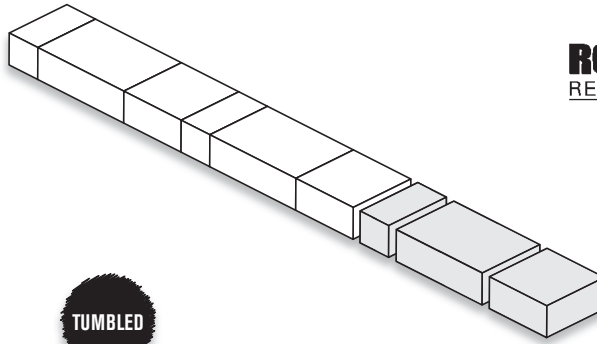

ROCKWOOD
RETAINING WALLS
A better way.™

Block	Size	Face Area	Weight	Units/Layer	Layers	Units/Pallet	Pallet Weight
Small	4 x 8 x 4" H	(2 piece sets)					
Medium	8 x 8 x 4" H	0.33 sq. ft.	31 lbs.	20	4	80 (26 sq. ft.)	2,530 lbs.
Large	12 x 8 x 4" H	0.33 sq. ft.	31 lbs.	20	4	80 (26 sq. ft.)	2,530 lbs.

To estimate number of units, divide total sq. ft. by 0.33.

Contemporary Wall

Rockwood Retaining Walls

Features

- Three-piece, one pallet system builds vertical, freestanding garden/retaining walls, planters, seat walls and outdoor living features
- Corner/Pillar block on separate pallet (Builds a 21 x 21 x 36" H pillar)
- Available by pallet only

Colors

- Beechwood
- Cascade
- Onyx

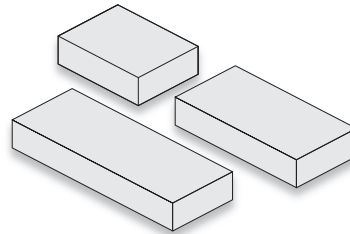

Block	Dimensions	Weight	Units/Layer	Layers	Units/Pallet	Pallets
Small	12 x 9 x 4" H	35 lbs.	3		18	
Medium	18 x 9 x 4" H	51 lbs.	2	6 (4 sq. ft. ea.)	12	2,466 lbs. (24 sq. ft.)
Large	24 x 9 x 4" H	68 lbs.	3		18	
Corner/Pillar	12 x 9 x 4" H	35 lbs.	12	3	36	1,260 lbs.

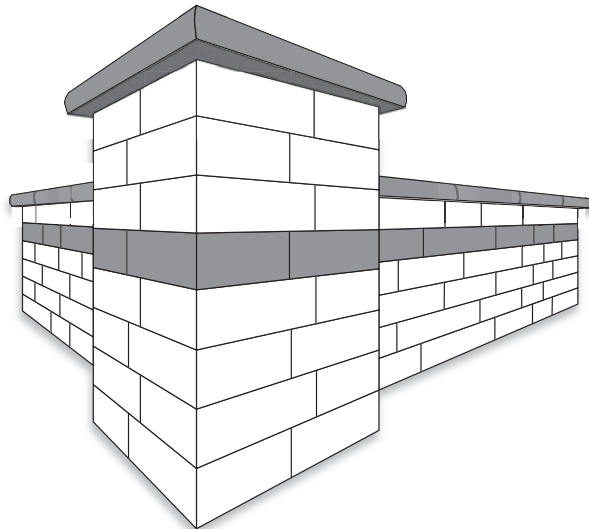

Classic® 6 and 8 Walls

Rockwood Retaining Walls

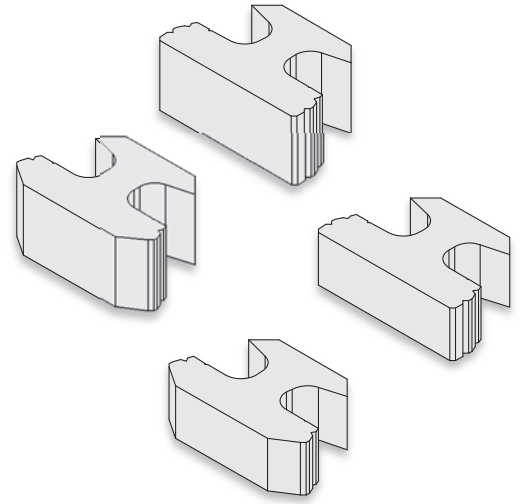

Features

- Straight face, (*beveled face is special order)
- Strong and versatile, efficient to build, one-unit system
- Matching half and corner block (2-3 day lead time req.)
- Cap with 4" Universal or Chiseled Cap
- Available by layer or pallet

Classic 6 Colors (1.0" setback)

- Bluestone (straight or beveled face)
- Charcoal (straight face)
- Gray (straight face)
- Sandstone (straight face)
- Sandstone Brown (straight or beveled face)
- Santa Fe (straight or beveled face)

Classic 8 Colors (1.0" setback)

- Brown (straight face)
- Gray (straight or beveled face)
- Sandstone (straight or beveled face)
- Sandstone Brown (straight face)
- Base block in gray only (straight face)

Classic 6	Size	Face Area	Weight	Units/Layer	Layers	Units/Pallet	Pallet Weight
Straight Face	18 x 12 x 6" H	0.75 sq. ft.	64 lbs.	12	3	36 (27 sq. ft.)	2,354 lbs.
Straight Base	18 x 12 x 6" H	0.75 sq. ft.	64 lbs.	12	3	36 (27 sq. ft.)	2,354 lb
Beveled Face	18 x 12 x 6" H	0.75 sq. ft.	60 lbs.	12	3	36 (27 sq. ft.)	2,210 lbs.
Half Block	9 x 12 x 6" H	0.38 sq. ft.	30 lbs.	12	1	12 (4.56 sq. ft.)	410 lbs.
Corner Block	13 x 5.5 x 6" H	0.54 sq. ft.	32 lbs.	12	1	12 (6.48 sq. ft.)	434 lbs.

To estimate number of units, divide total sq. ft. by 0.75 for Classic 6.

Classic 8	Size	Face Area	Weight	Units/Layer	Layers	Units/Pallet	Pallet Weight
Straight Face	18 x 12 x 8" H	1 sq. ft.	85 lbs.	12	2	24 (24 sq. ft.)	2,090 lbs.
Straight Base (gray only)	18 x 12 x 8" H	1 sq. ft.	85 lbs.	12	2	24 (24 sq. ft.)	2,090 lbs.
Beveled Face	18 x 12 x 8" H	1 sq. ft.	79 lbs.	12	2	24 (24 sq. ft.)	1,946 lbs.
Half Block	9 x 12 x 8" H	0.50 sq. ft.	39 lbs.	12	1	12 (6 sq. ft.)	518 lbs.
Solid Corner Block**	18 x 9 x 8" H	1 sq. ft.	100 lbs.	5	4	20 (20 sq. ft.)	2,050 lbs.

** Rochester and Beaver Dam only.

Classic® 8 DOT Wall Block and Caps

Rockwood Retaining Walls

- Straight face in Sandstone or Gray
- Beveled face is special order colors

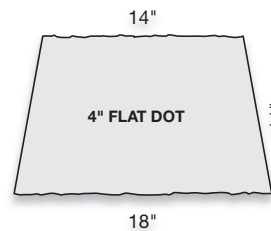
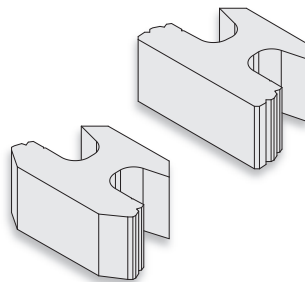

Split face front/back.
Spec'd in WI.

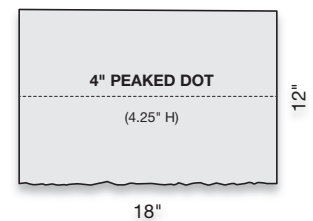

Split face front.
Spec'd in MN and IA.

Classic 8 DOT	Size	Face Area	Weight	Units/Layer	Layers	Units/Pallet	Pallet Weight
Straight Face	18 x 12 x 8" H	1 sq. ft.	87 lbs.	12	2	24 (24 sq. ft.)	2,130 lbs.
Beveled Face*	18 x 12 x 8" H	1 sq. ft.	82 lbs.	12	2	24 (24 sq. ft.)	2,018 lbs.
4" Flat Cap	18 W x 11 x 4" H (Front)						
	14 W x 11 x 4" H (Back)	1.5 ln. ft.	55 lbs.	9	4	36 (27 ln. ft.)	2,030 lbs.
4" Peaked Cap	18 W x 12 x 4" H	1.5 ln. ft.	70 lbs.	8	4	32 (21 ln. ft.)	2,290 lbs.

*Beveled face is special order.

Classic® 8 Chiseled Face Wall

Rockwood Retaining Walls

Features

- The look of handcrafted stone
- A strong and versatile, efficient to build, one-unit system
- Matching base and corner blocks
- Matching half and corner block (2-3 day lead time req.)
- 0.5" setback
- Cap with 4" Universal, 3" or Chiseled Cap

ROCKWOOD®
RETAINING WALLS
A better way.™

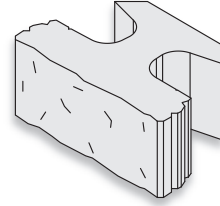

Colors

- Bluestone
- Santa Fe

Block	Size	Face Area	Weight	Units/Layer	Layers	Units/Pallet	Pallet Weight
Chiseled Face Block	18 x 12 x 8" H	1 sq. ft.	80 lbs.	12	2	24 (24 sq. ft.)	1,970 lbs.
Base Block	18 x 12 x 8" H	1 sq. ft.	80 lbs.	12	2	24 (24 sq. ft.)	1,970 lbs.
Corner Block	13 x 5.5 x 8" H	0.72 sq. ft.	40 lbs.	12	1	12 (16.6 sq. ft.)	530 lbs.

Classic Colonial® 6 Wall

Classic 8 Colonial® 8 Wall (special order)

Rockwood Retaining Walls

Features

- Multi-unit appearance, rustic face
- A strong and versatile, efficient to build, one-unit system
- Matching base, corner and half blocks
- Matching half and corner block (2-3 day lead time req.)
- Cap with 4" Universal or Chiseled Cap
- 1.0" Setback

ROCKWOOD®
RETAINING WALLS
A better way.™

Classic Colonial 6

- Available by layer or pallet
- Bluestone
- Santa Fe
- Sandstone Brown

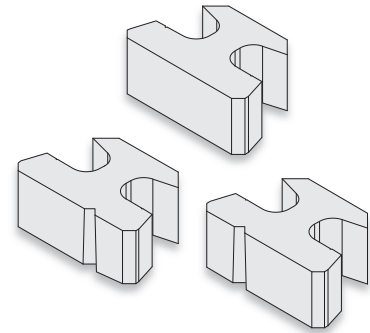
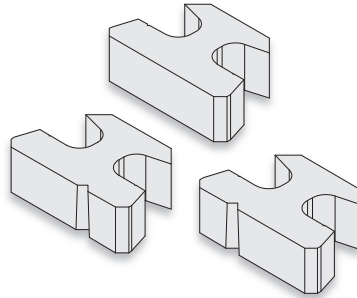

Classic Colonial 8* (special order)

- Straight split only
- Can be made in any color

Classic Colonial 6	Size	Face Area	Weight	Units/Layer	Layers	Units/Pallet	Pallet Weight
Colonial 18	18 x 12 x 6" H	0.75 sq. ft.	60 lbs.	12	3	36 (27 sq. ft.)	2,210 lbs.
Colonial 6/12	18 x 12 x 6" H	0.75 sq. ft.	60 lbs.	12	3	36 (27 sq. ft.)	2,210 lbs.
Base Block	18 x 12 x 6" H	0.75 sq. ft.	60 lbs.	12	3	36 (27 sq. ft.)	2,210 lbs.
Half Block	9 x 12 x 6" H	0.38 sq. ft.	30 lbs.	12	1	12 (4.56 sq. ft.)	410 lbs.
Corner Block	13 x 5.5 x 6" H	0.54 sq. ft.	32 lbs.	12	1	12 (6.48 sq. ft.)	434 lbs.

Colonial 6/12 and 18 palletized separately. To estimate number of Classic Colonial 6 units, divide total sq. ft. by 0.75.

Classic Colonial 8*	Size	Face Area	Weight	Units/Layer	Layers	Units/Pallet	Pallet Weight
Colonial 18	18 x 12 x 8" H	1 sq. ft.	85 lbs.	12	2	24 (24 sq. ft.)	2,090 lbs.
Colonial 6/12	18 x 12 x 8" H	1 sq. ft.	85 lbs.	12	2	24 (24 sq. ft.)	2,090 lbs.
Base Block (gray only)	18 x 12 x 8" H	1 sq. ft.	85 lbs.	12	2	24 (24 sq. ft.)	2,090 lbs.
Half Block	9 x 12 x 8" H	0.50 sq. ft.	39 lbs.	12	1	12 (6 sq. ft.)	518 lbs.
Corner Block	13 x 5.5 x 8" H	0.72 sq. ft.	40 lbs.	12	1	12 (8.64 sq. ft.)	530 lbs.

* Set-up fee and minimum quantity required, customer must take entire production run. Returns not allowed.

Premier 8 Wall (special order)

Rockwood Retaining Walls

Features

- Less weight than Classic 8
- Straight split face only
- 54 lbs, more blocks per load
- 1.0" setback
- Special order – set-up fee and minimum quantities apply

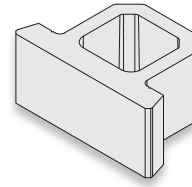

Block	Size	Face Area	Weight	Units/Layer	Layers	Units/Pallet	Pallet Weight
Straight Split	18 x 12 x 8" H	1 sq. ft.	54 lbs.	9	4	36 (36 sq. ft.)	1,994 lbs.
Solid Corner Block*	18 x 9 x 8" H	1 sq. ft.	100 lbs.	5	4	20 (20 sq. ft.)	2,050 lbs.

* Split on two sides

StoneHedge 6 Wall (special order)

Rockwood Retaining Walls

Features

- Split face front and back
- Vertical system, integrates with Classic blocks
- Creates seat walls, enclosures and privacy walls
- Special order – set-up fee and minimum quantities apply

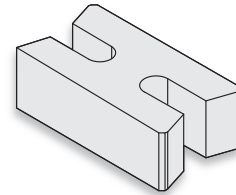

StoneHedge block can be made in any color. Set-up fee and minimum quantity required, customer must take entire production run. Returns not allowed.

Block	Size	Face Area	Weight	Units/Layer	Layers	Units/Pallet	Pallet Weight
Straight	18 x 10 x 6" H	0.75 sq. ft.	64 lbs.	8	3	24 (18 sq. ft.)	1,586 lbs.
Half Unit	6 x 10 x 6" H	0.38 sq. ft.	32 lbs.			12 (4.56 sq. ft.)	434 lbs.

To estimate number of units, divide total sq. ft. by 0.75.

Sapphire 6 Wall

Rockwood Retaining Walls

Features

- Straight face, smooth top
- Partial cores equal less weight
- Efficient to build, rear-lip system
- Cap with 3" or 4" Universal Cap
- Available by layer or pallet

Colors

- Beechwood
- Cascade (Spring 2020)
- Santa Fe
- Gray



Sapphire's radius bottom eliminates the need for cleaning courses, saving time and hassle. Its rear-lip automatically creates a 1" setback.

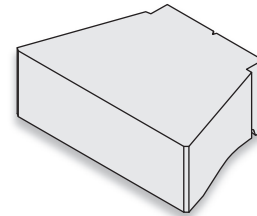

Block	Size	Face Area	Weight	Units/Layer	Layers	Units/Pallet	Pallet Weight
Straight	17.25 x 12 x 6" H	0.75 sq. ft.	68 lbs.	9	5	45 (33.75 sq. ft.)	3,100 lbs.
Corner	16 x 8 x 6" H	0.66 sq. ft.	61 lbs.	12	4	48 (32 sq. ft.)	3,002 lbs.

Corners are split on one 16" and 8" side.

Discontinued products available until gone, call for availability.



Rochester
Concrete Products™

Legend Wall (special order)

Rockwood Retaining Walls

Features

- The ultimate block for challenging applications
- Straight or beveled face options
- Efficient to build, one-unit system
- 1.0" setback

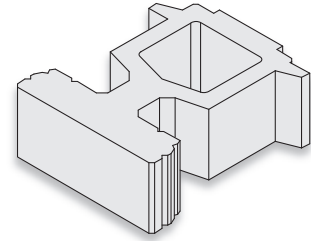

Legend block can be made in any color. Set-up fee and minimum quantity required, customer must take entire production run. Returns not allowed.

Face	Size	Face Area	Weight	Units/Layer	Layers	Units/Pallet	Pallet Weight
Straight	18 x 22 x 8" H	1 sq. ft.	131 lbs.	4	4	16 (16 sq. ft.)	2,146 lbs.
Beveled	18 x 22 x 8" H	1 sq. ft.	125 lbs.	4	4	16 (16 sq. ft.)	2,050 lbs.

Stonegate Wall

Keystone Retaining Wall Systems

Features

- Three-piece*, one-pallet system
- Vertical or adjustable setback
- Tumbled, aged appearance
- Cap with Lakeland Block or Chiseled Cap
- Available by pallet

Colors

- Beechwood
- Bluestone
- Santa Fe

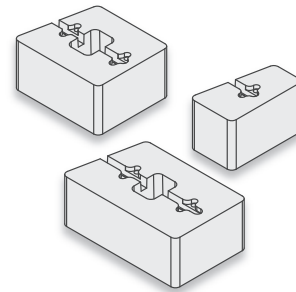

Name	Size	Back	Face Area	Weight	Sets/Layer	Layers	Sets/Pallet	Pallet Weight
Unit 16/14	16 x 10 x 6" H	14" W						
Unit 12/10	12 x 10 x 6" H	10" W	1.41 sq. ft.	140 lbs.	8	3	24 (33.84 sq. ft.)	3,250 lbs
Unit 6/4	6 x 10 x 6" H	4" W						

* Dry stack/pin connection method (1-2 SHOULDERED pins required per unit)

Compac Wall

Keystone Retaining Wall Systems

Features

- Straight-split face only
- 1.0" set back
- Cap with 4" Universal or Chiseled Cap
- Available by pallet

Colors:

- Sandstone
- Gray

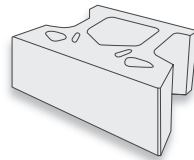

Name	Size	Face Area	Weight	Units/Layer	Layers	Units/Pallet	Pallet Weight
Block	18 x 12 x 8" H	1 sq. ft.	78 lbs.	9	4	36 (36 sq. ft.)	2,860 lbs.
Corner	18 x 9 x 8" H	1 sq. ft.	100 lbs.	10	2	20 (20 sq. ft.)	2,050 lbs.

* Dry stack/pin connection method (1-2 NON-SHOULDERED pins required per unit)

Standard Wall (special order)

Keystone Retaining Wall Systems

Features

- Adjustable setback
- Strong, structural retaining wall system
- Dry stack/pin connection method (1-2 pins required per unit)
- Cap with Rockwood Universal cap
- Available by pallet

Colors

- Sandstone
- Gray

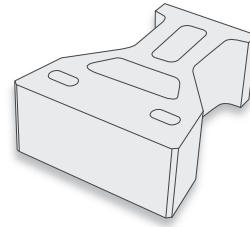

Size	Face Area	Weight	Units/Layer	Layers	Units/Pallet	Pallet Weight
18 x 21 x 8" H	1 sq. ft.	105 lbs.	9	2	18 (18 sq. ft.)	1,940 lbs.

Connection Pins (1-2 pins required per unit)

Type	Size	Pins/Box	Pins/Pallet
Shouldered Pin	.5 x 3.75" L	100	24,200
Use with Stonegate and Country Manor wall block			
Non-shouldered Pin	.5 x 5.25" L	100	24,000
Use with Standard and Compac wall block			



Cottage Stone Wall

Rockwood Retaining Walls

Features

- Beveled face, create straight or curved garden walls, tree rings and planters
- Curved bottom aids fast install
- 0.5" setback
- To estimate number of units, divide total sq. ft. by 0.33
- Cannot be double stacked
- Available by pallet

Colors

- Brown
- Charcoal
- Gray
- Sandstone
- Sandstone Brown

ROCKWOOD[®]
RETAINING WALLS
A better way.™

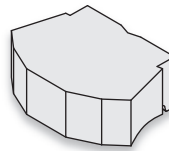

Size	Face Area	Weight	Units/Layer	Layers	Units/Pallet	Pallet Weight
12 x 8.5 x 4" H	0.33 sq. ft.	25 lbs.	16	6	96 (31.68 sq. ft.)	2,450 lbs.

ONLINE HARDSCAPES CALCULATOR

Quickly and easily calculate paver and materials requirements from your desktop or mobile device. Send yourself a PDF of the results for your project planning.

Go to: www.rochesterpc.com/estimator/

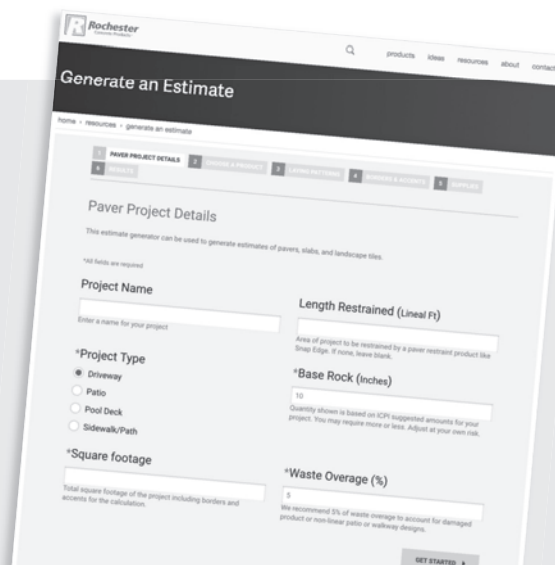

Recon Wall

Recon Wall Systems

Features

- Strong, wet cast blocks 1,457 to 4,088 lbs.
- 24" to 84" D x 48" W x 16" H
- Regular corner and cap blocks
- Half block (24" or 39" deep)
- Full fence or full high end/cap blocks
- Available in two unique faces
- Gray color (stain applied after construction)
- Passed current WI DOT requirements

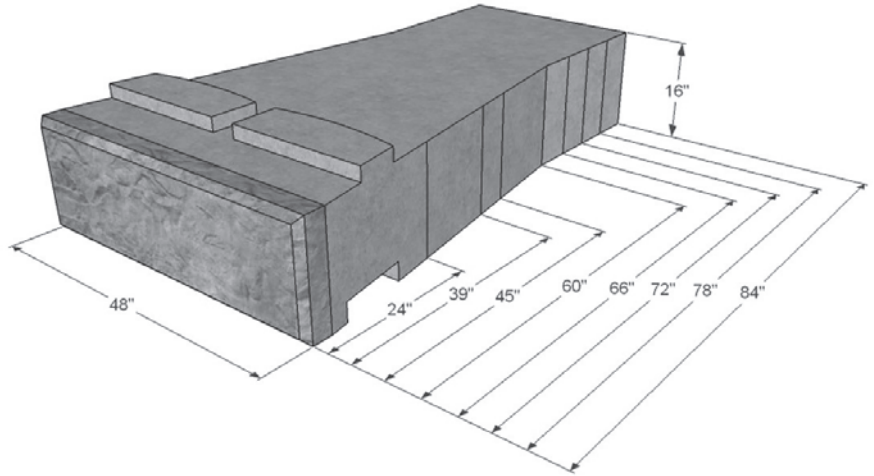

Block	Size W x D x H	Face Area	Weight
Full Base Block - 24"	48 x 24 x 16" H	5.33 sq. ft.	1,457 lbs.
Full Base Block - 39"	48 x 39 x 16" H	5.33 sq. ft.	2,201 lbs.
Full Base Block - 45"	48 x 45 x 16" H	5.33 sq. ft.	2,491 lbs.
Full Base Block - 60"	48 x 60 x 16" H	5.33 sq. ft.	3,115 lbs.
Full Base Block - 66"	48 x 66 x 16" H	5.33 sq. ft.	3,416 lbs.
Full Base Block - 72"	48 x 72 x 16" H	5.33 sq. ft.	3,660 lbs.
Full Base Block - 78"	48 x 78 x 16" H	5.33 sq. ft.	3,902 lbs.
Full Base Block - 84"	48 x 84 x 16" H	5.33 sq. ft.	4,088 lbs.
Full Top Block - 24"	48 x 24 x 16" H	5.33 sq. ft.	971 lbs.
Regular Corner	48 x 24 x 16" H	5.33 sq. ft.	1,401 lbs.
Corner Top	48 x 24 x 16" H	5.33 sq. ft.	1,103 lbs.
Half Block 24"	48 x 24 x 16" H	5.33 sq. ft.	667 lbs.
Half Block 39"	48 x 36 x 16" H	5.33 sq. ft.	973 lbs.
Capstone	48 x 26 x 6.5" H	2.16 sq. ft.	551 lbs.
Fence Middle Block	16 x 48 x 24" H	2.66 sq. ft.	1,449 lbs.
Fence Middle End Block	16 x 48 x 24" H	2.66 sq. ft.	1,476 lbs.
Half Fence Middle End Block	16 x 24 x 24" H	2.66 sq. ft.	709 lbs.
Guardrail Middle Block	16 x 48 x 24" H	2.66 sq. ft.	1,373 lbs.

Installation details at:
www.reconwalls.com



Le Sueur County Limestone

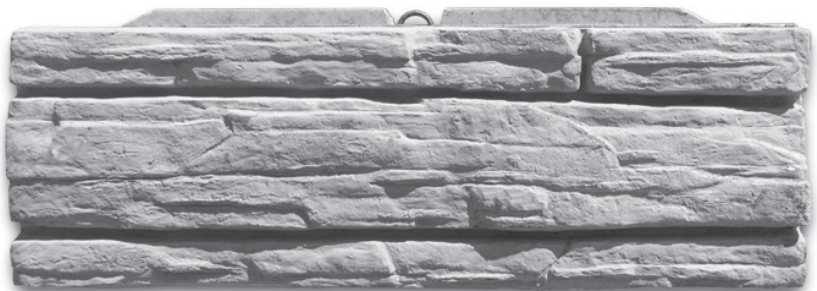

Weathered Edge

- Non-KolorLast
- With KolorLast

Pavers/Slabs	Antique Brown	Antique Copper	Beechwood	Bluestone	Brown	Buff	Carmel	Cascade	Desert Buff	Moonlight Gray	Onyx	Natural	Rosewood	Santa Fe	Sierra Gray	Tuscan Red
American Brick					●	●					●					●
Barrington	●		●	●				●						●		
Broadmour 6cm/Plank			●					○			●	○				
Broadmour 10cm			○					○			●	○				
Bullnose Paver					○	○					○	○				
Cobble Stone			○							○	●					
Colonial		○	○							○						
Colonial 4x6 and 6x9					○	○					●					
Flagstone	○													○	○	
Holland 6cm		○	○		○	○				○	●		○			
Holland-Eco			○				○									
Lamont	○		○		8x4 8x6				8x4 8x6	8x4 8x6				○	○	
Mezzano	●		●	●				●						●		
Minnetonka	●		●	●				●						●		
Serano	●		●	●				●						●		
6 x12 Accent						●		●			●					

- Special Order Pavers:**
- Broadmour 10cm (except Plank)
 - Colonial 8cm
 - Holland 8cm
 - Turfstone-Eco

- Special Order Walls:**
- Big Step
 - Classic 8 Beveled Face
 - Classic 8 Colonial
 - Keystone Standard
 - Legend
 - Premier 8
 - StoneHedge 6

*Barn Plank tiles are manufactured with a surface applied protectant to help resist the harmful effects of time, Mother Nature, acid rain and stains.

Need a special color? Paver and block custom color production runs are available. Set-up fees apply, minimum quantities required and customer must take 100% of product run. Inquire with your regional RCP Sales Representative for details.



Tiles, Steps, Caps, Garden Wall and Edging	Beechwood	Brown	Buff	Bluestone	Carmel	Charcoal	Cream	Fond du Lac	Gray	Indiana Limestone	Ivory	Mahogany*	Natural	Red Black	Sandstone	Santa Fe	Weathered Gray*
Antique Travertine											●		●				
Barn Plank												●					●
Bullet Edger	●		●		●	●											
Classic® Edger		●				●		●						●	●		
Chiselled Steps			●	●					●								
Chiselled Caps			●	●					●								
Granite Edger				●												●	
Grand Step	●		●			●							●				
Slate Tiles				●			●	●									
Stepping Stones			●	●					●								

Retaining Walls	Beechwood	Bluestone	Brown	Cascade	Charcoal	Copper Canyon	Desert	Fond du Lac	Gray	Onyx	Pacific Gray	Sandstone	Sandstone/Brown	Santa Fe
Classic 6		Str. Bev.			Str.				Str.			Str.	Str. Bev.	Str. Bev.
Classic 8			Str.						Str. Bev.			Str. Bev.	Str.	
Classic 8 DOT/Cap									Str.			Str.		
Classic 8 Chiseled		●												●
Classic Colonial		●											●	●
Contemporary	●			●						●				
Cottage Stone			●		●			●			●	●		
Lakeland/Riverland	●	●		●			Kits Only			●				●
Rosetta Walls					●			●			●			
Sapphire	●			●				●				●		●
Stonegate C. Manor	●	●		●										●
Vintage 6	●	●												●

Wall Cap	Beechwood	Bluestone	Brown	Cascade	Charcoal	Gray	Sandstone	Sandstone/Brown	Santa Fe
4" Universal		●	●		●	●	●	●	●
3" Universal	●	●				●			●
3" Tumbled	●	●		●					●
Mini Cap			●		●	●	●	●	

Product availability subject to change. Refer to actual product samples when making color selection.

If it's not KolorLast, it's just concrete!

Frequently asked questions:

Q: How long should I wait before sealing KolorLast pavers?

A: KolorLast treated pavers can be sealed immediately after installation.

Q: Do I need to use an efflorescence cleaner prior to sealing Kolorlast pavers?

A: Should efflorescence from the joint side of KolorLast pavers appear on the paver surface you will need to use efflo-clean prior to sealing.

Q: Should I use water-based or a solvent-based sealers?

A: KolorLast is compatible with most post-applied sealers, including polyurethane, acrylic and water based products. Silane/siloxane based products are not recommended (they do not penetrate).

Always follow manufacturer's instructions when using cleaning and sealing products and test in a small/inconspicuous area prior to application.



KolorLast
Hardscape Protectant





**NATURE CAN
BE ONE TOUGH
MOTHER TO YOUR
NEW PAVERS.**

PROTECT THEM!



Years later, it's easy to tell
unprotected pavers...

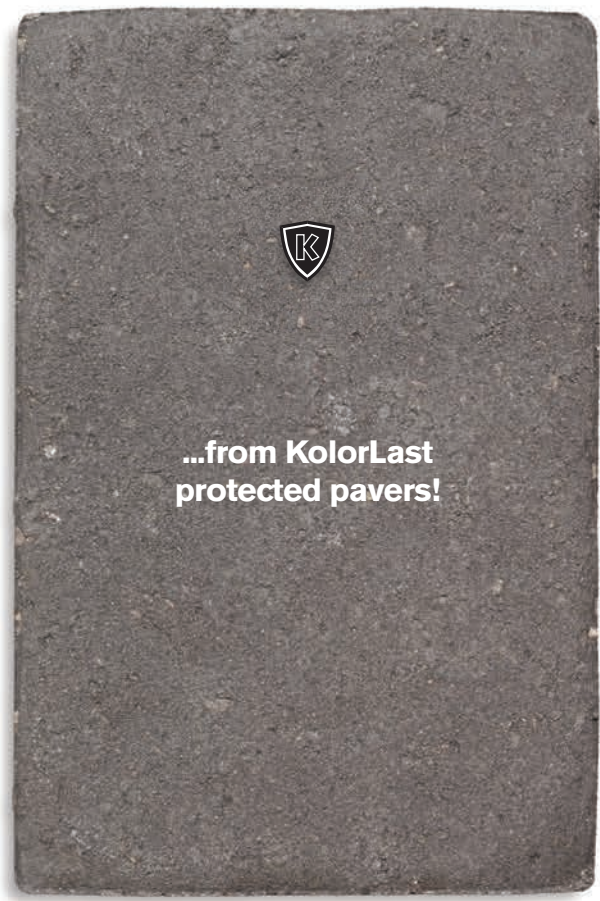

...from KolorLast
protected pavers!

KolorLast is serious protection

Concrete treated with KolorLast is highly resistant to the harmful effects of salt, chemical and acid rain exposure. And, KolorLast pavers are much easier to clean – easily remove oil, food spills, animal/pet and rust marks that would likely foul the looks ordinary pavers.

What is KolorLast?

The KolorLast manufacturing process is a simple chemical reaction between two compounds. First, a special mixture of cement, aggregates, water and a proprietary chemical additive are mixed into dry-mix concrete that is pressed into molds with extreme heat and pressure. Second, as pavers are demolded, a proprietary water-based solution is sprayed on the surface where a chemical/molecular reaction creates the KolorLast protective layer. This new protective compound penetrates into the surface of the paver – three to five millimeters deep. It can only be removed with heavy abrasion/wear.

KolorLast Protected pavers are:

- Fade Resistant
- Stain Resistant
- Acid Rain Resistant
- Salt Resistant
- Spalling Resistant
- Inhibits Efflo and Poly Haze

If it's not KolorLast – it's just concrete.



KolorLast™
Hardscape Protectant

Slate Landscape Tile

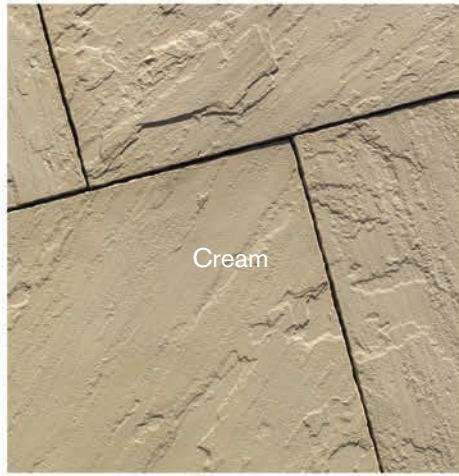
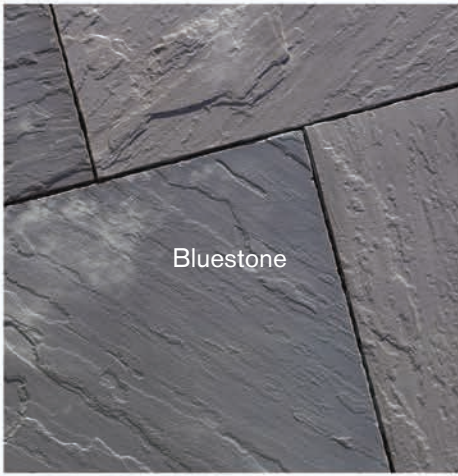

Antique Travertine Landscape Tile



Colors may vary widely between production runs. Pull product from multiple pallets to blend colors and enhance the aesthetic. Color swatches may or may not be shown with wet-look sealer. Refer to actual product samples when making color selection.

Lamont Paver

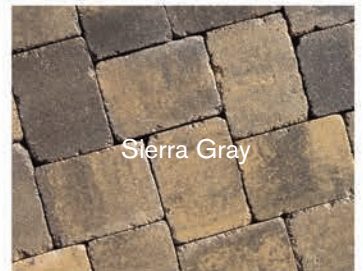
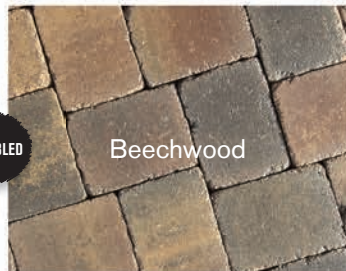
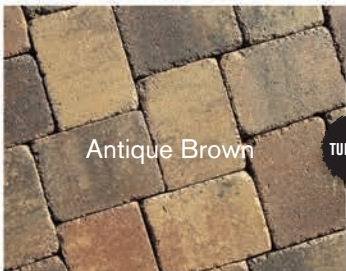

TUMBLED

Colonial Paver

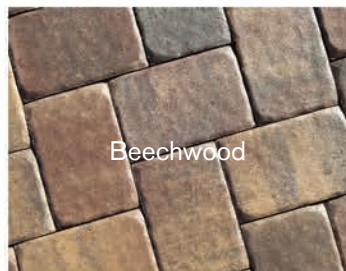
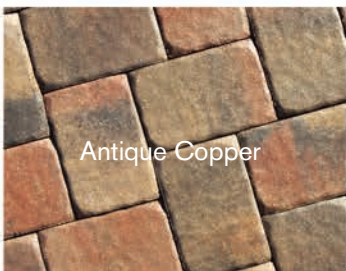

Holland Paver

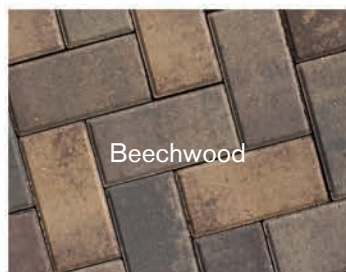

Barn Plank Landscape Tile



Weathered Gray



Mahogany



Barn Plank tiles are manufactured with a surface applied protectant to help resist the harmful effects of time, Mother Nature, acid rain and stains.

Barn Plank Garden Wall



Weathered Gray



Mahogany



Brown



Buff



Onyx



Buff



Onyx



Carmel



Beechwood



Brown



Buff



Onyx

Barrington Paver



Antique Brown

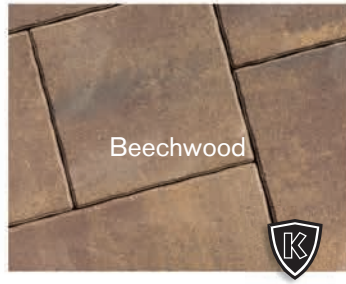

Beechwood



Bluestone



Cascade

Minnetonka Paver



Antique Brown



Beechwood



Bluestone



Cascade

Serano Paver



Antique Brown



Beechwood



Bluestone



Cascade

Mezzano Paver



Antique Brown



Beechwood



Bluestone



Cascade

Broadmour Plank Paver

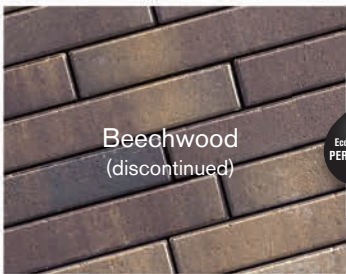

Beechwood
(discontinued)



Cascade



Natural



Onyx



Broadmour Pavers

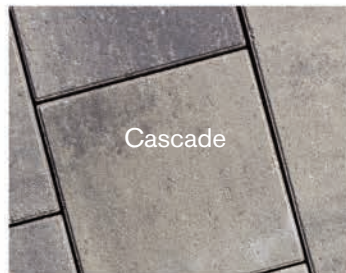

Cascade



Natural



Onyx



Colors may vary widely between production runs. Pull product from multiple pallets to blend colors and enhance the aesthetic. Color swatches may or may not be shown with wet-look sealer. Refer to actual product samples when making color selection.

6 x 12 Smooth Accent Paver



Santa Fe



Brown



Buff



Onyx



6 x 12 Slate Accent Paver



Santa Fe



Brown



Buff



Onyx



Cobble Stone Paver



Santa Fe



Beechwood



Moonlight Gray

Eco-Friendly PERMEABLE



Onyx



Flagstone Paver



Santa Fe



Antique Brown



Santa Fe



Sierra Gray



American Brick Paver



Brown



Buff



Tuscan Red



Onyx



Gray

Brown

Sandstone

Red/Black

Charcoal



Beechwood

Buff

Carmel

Charcoal

Classic 6 & 8 Walls



Cottage Stone Wall



Sapphire 6 Wall



Lakeland/Riverland Walls

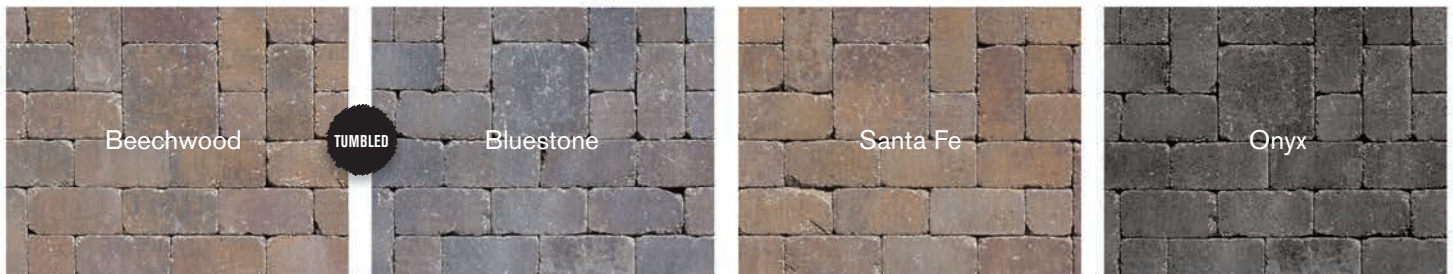

Vintage 6 Wall



Stonegate Wall



Colors may vary widely between production runs. Pull product from multiple pallets to blend colors and enhance the aesthetic. Color swatches may or may not be shown with wet-look sealer. Refer to actual product samples when making color selection.



Sandstone Brown



Sandstone



Santa Fe



Contemporary Wall



Sandstone



Beechwood w/Onyx



Cascade w/Onyx

Classic Colonial 6 Wall



Bluestone



Sandstone/Brown

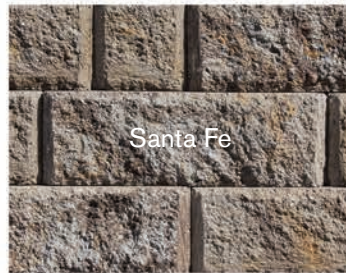

Santa Fe

Classic 8 Chiseled Face Wall

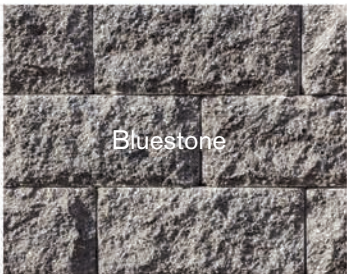

Bluestone

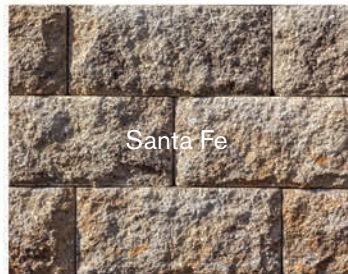

Santa Fe

Stepping Stones



Bluestone



Buff



Indiana Limestone

Cap and Tops



Bluestone



Buff



Indiana Limestone

Wet Cast Steps



Weathered Gray Barn Plank



Mahogany Barn Plank



Ivory Travertine, **Natural** (not shown)



Indiana Limestone
Chiseled 1 and 3 Sided

Buff
Chiseled 1 and 3 Sided



Bluestone
Chiseled 1 and 3 Sided



Grand Step



Buff



Natural

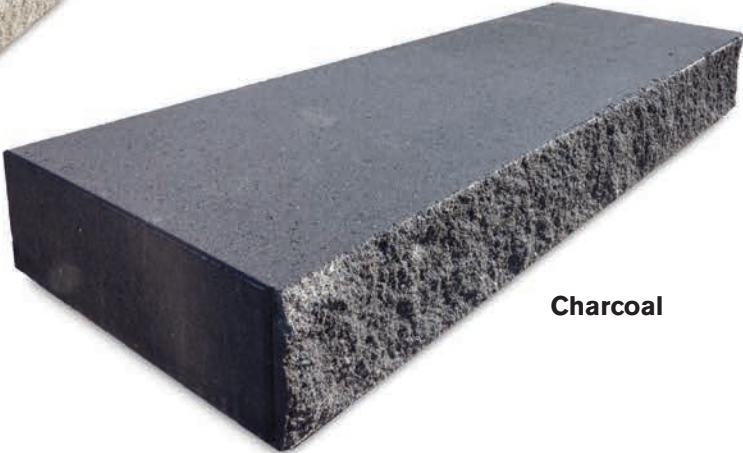

Charcoal



Beechwood

Grand Steps have a straight split riser on one side with a smooth riser and bevel top on the opposite side.



Outcropping Wall

Rosetta Hardscapes

Features

- Stong, wet cast wall blocks for serious performance and curb appeal
- 6", 12", 18" and 24" heights
- Fourteen unique shapes in 2' to 6' widths
- 15° setback (3")
- Lifting device required, available for purchase or rent (53 lbs.)
- Available by pallet

Colors

- Copper Canyon
- Fond du Lac
- Pacific Gray



Pallet	Sizes	Pallet	Pallet Weight
Pallet A	3.5' x 1', 4' x 1', 5' x 1', 5.5' x 1'	18 sq. ft.	4,000 lbs.
Pallet B	2' x .5', 3' x .5', 3' x 1', 4' x .5', 4.5' x 1', 6' x 1'	18 sq. ft.	4,000 lbs.
Pallet C	2' x .5', 3' x .5', 5' x 1.5', 4' x 2'	18 sq. ft.	4,000 lbs.
Corner	30" x 48" x 12" H (3 per pallet)	19.5 sq. ft.	3,650 lbs.

Outcropping Patterns

Each pattern is 90 sq. ft. = (2) A pallets + (2) B pallets + (1) C pallet

2' x 45' Pattern

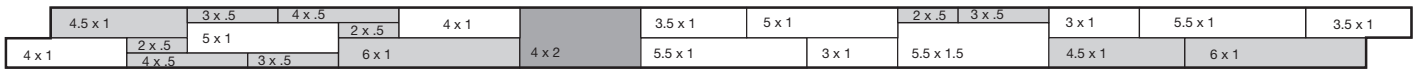

3' x 30' Pattern

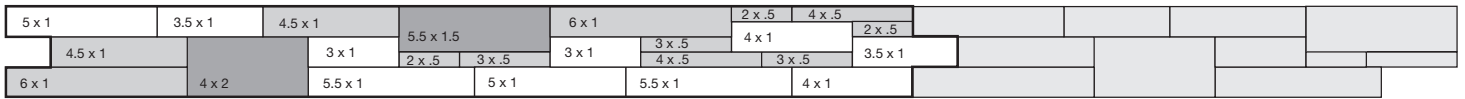

4' x 22.5' Pattern

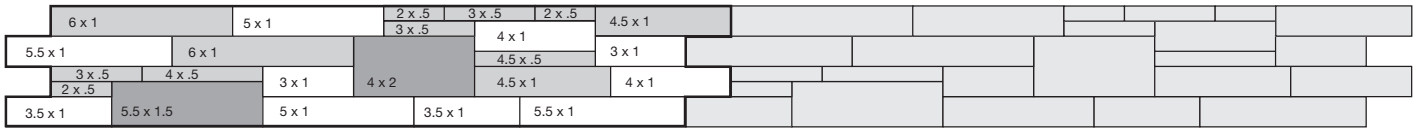

5' x 18' Pattern

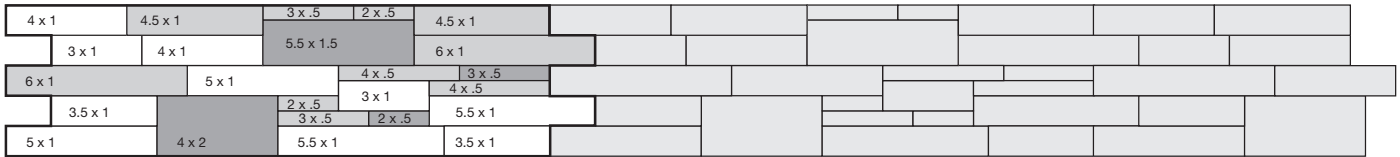

Irregular and Dimensional Steps

Rosetta Hardscapes

- Wet cast, varied appearance
- 3.5 to 6 ft. wide x 7" H
- Available by pallet

Colors

- Copper canyon
- Fond du Lac
- Pacific Gray



Size	Weight	Units/Pallet	Pallet Weight
Irregular x 7" H	493 lbs.	6	3,008 lbs.
72 x 30 x 7" H (special order)	1,320 lbs.	3	4,010 lbs.

Kodah Wall

Rosetta Hardscapes

Features

- Four-unit system, two-sided, wet cast blocks
- Builds freestanding near-vertical seat and retaining walls
- Matching corner/end blocks
- 3/4" setback
- Available by pallet

Colors

- Copper Canyon
- Fond du Lac
- Pacific Gray



Pallet	Size	Face Area	Weight	Units/Pallet	Pallet Weight
Wall Pallet	42 x 10.5 x 6" H	1.75 sq. ft.	200 lbs.	6	Sold in sets (21 sq. ft.) 2,400 lbs
	30 x 10.5 x 6" H	1.25 sq. ft.	140 lbs.	3	
	21 x 10.5 x 6" H	0.88 sq. ft.	100 lbs.	6	
	12 x 10.5 x 6" H	0.50 sq. ft.	50 lbs.	3	
Corner Pallet	21 x 10.5 x 6" H	0.88 sq. ft.	100 lbs.	24 (21 sq. ft.)	2,400 lbs.

Belvedere Wall

Rosetta Hardscapes

Features

- 64 unique stone textures create the look of naturally weathered stone
- Two-sided units create vertical pillars, freestanding walls and outdoor features
- Strong and versatile retaining wall system
- 1/2" setback
- Available by pallet

Colors

- Copper Canyon
- Fond du Lac
- Pacific Gray



RETAINING WALL PALLET

Size	Back	Face Area	Weight	Units/Pallet	Pallet Weight
6 x 9 x 3" H	4" W	0.125 sq. ft.	10 lbs.	12	Sold in sets
12 x 9 x 3" H	10" W	0.25 sq. ft.	22 lbs.	12	2,475 lbs. (27 sq. ft.)
18 x 9 x 3" H	16" W	0.375 sq. ft.	36 lbs.	12	
6 x 9 x 6" H	4" W	0.25 sq. ft.	21 lbs.	12	
12 x 9 x 6" H	10" W	0.50 sq. ft.	42 lbs.	12	
18 x 9 x 6" H	16" W	0.75 sq. ft.	67 lbs.	12	

CORNER PALLET One pallet of corner block builds a 24 x 24 x 36" pillar

Size	Back	Face Area	Weight	Units/Pallet	Pallet Weight
15 x 9 x 3" H	14" W	0.313 sq. ft.	30 lbs.	16	Sold in sets
15 x 9 x 6" H	14" W	0.625 sq. ft.	58 lbs.	16	1,520 lbs. (24 sq. ft.)

COPING (CAPS) PALLET Caps can only be purchased in 11 lineal feet increments.

Size	Back	Face Area	Weight	Units/Pallet	Pallet Weight
4 x 10.25 x 2.25" H	6" W	0.33 ln. ft.	9 lbs.	24	Sold in sets
12 x 10.25 x 2.25" H	10" W	1.0 ln. ft.	20 lbs.	24	1,552 lbs. (33 ln. ft.)
18 x 10.25 x 2.25" H	16" W	1.5 ln. ft.	30 lbs.	12	
18 x 10.25 x 2.25" H Right End	17" W	1.5 ln. ft.	29 lbs.	6	
18 x 10.25 x 2.25" H Left End	17" W	1.5 ln. ft.	34 lbs.	6	
27 x 27 x 2.5" H Pillar Cap		5.06 sq. ft.	150 lbs.	10	1,550 lbs. (50.6 sq. ft.)

Rosetta Tech Guides available online. www.rosettahardscapes.com

Retaining Wall Caps

Rockwood Retaining Walls

ROCKWOOD[®]
RETAINING WALLS
A better way.[™]

• Available by pallet or layer

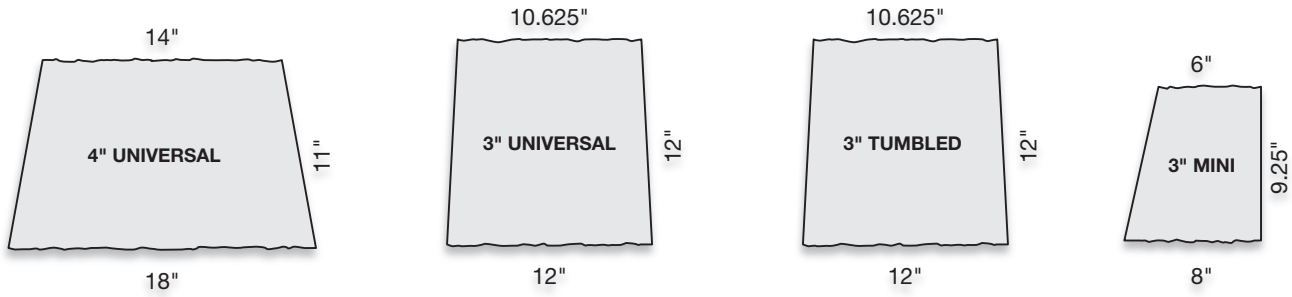

4" Universal Cap Colors

- Bluestone
- Brown
- Charcoal
- Gray
- Sandstone
- Sandstone Brown
- Santa Fe

3" Universal Cap Colors

- Beechwood
- Bluestone
- Desert Buff (discontinued)
- Gray
- Santa Fe

3" Tumbled Cap Colors

- Beechwood
- Bluestone
- Cascade (Spring 2020)
- Santa Fe

Mini Cap Colors

- Brown
- Charcoal
- Gray
- Sandstone
- Sandstone Brown



Cap	Size	Face	Weight	Units/Layer	Layers	Units/Pallet	Pallet Weight
4" Universal	18 W x 11 x 4" H (Front)	1.5 ln. ft.	54 lbs.	9	4	36 (54 ln. ft.)	1,994 lbs.
	14 W x 11 x 4" H (Back)						
<i>To estimate Universal Cap, divide wall length by 1.33</i>							
3" Universal and Tumbled	12 x 12 x 3" H (Front)	1 ln. ft.	26 lbs.	12	4	48 (48 ln. ft.)	1,298 lbs.
	10.625 x 12 x 3" H (Back)						
Mini Cap	8 x 9.25 x 3" H (Front)	0.67 ln. ft.	15.2 lbs.	52	2	104 (69 ln. ft.)	1,630 lbs.
	6 x 9.25 x 3" H (Back)						
<i>To estimate Mini Cap, divide wall length by 0.58</i>							

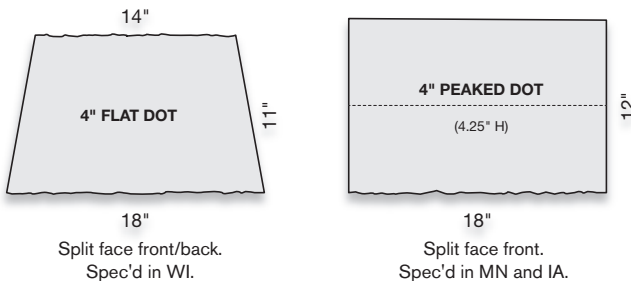

ROCKWOOD[®]
RETAINING WALLS
A better way.[™]

DOT Cap Sandstone or Gray color

4" Flat Cap	18 W x 11 x 4" H (Front)	1.5 ln. ft.	55 lbs.	9	4	36 (27 ln. ft.)	2,030 lbs.
	14 W x 11 x 4" H (Back)						
4" Peaked Cap	18 W x 12 x 4" H	1.5 ln. ft.	70 lbs.	8	4	32 (21 ln. ft.)	2,290 lbs.

Wet Cast Steps

Silver Creek Stoneworks

Barn Plank Step Colors

- Mahogany
- Weathered Gray

Travertine Step Colors

- Ivory
- Natural

Chiseled Step Colors

- Bluestone
- Buff
- Indiana Limestone

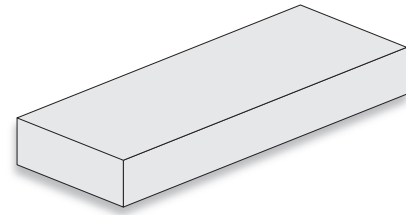

Name	Size	Weight	Units/Pallet	Pallet Weight	Details
Barn Plank Step	48 x 18 x 5.75" H	450 lbs.	4	1,850 lbs.	Detailed grain on 5-sides
Travertine Step	48 x 18 x 5.75" H	450 lbs.	4	1,850 lbs.	Detailed texture, honed surfaces
Chiseled Step	48 x 18 x 5.75" H	450 lbs.	4	1,850 lbs.	One sided/smooth top or three sides/rough top

Notes: Available by pallet only. One and three sided steps CANNOT be used together.

Grand Step

Interlock Concrete Products

- Smooth riser w/front bevel on one side, straight split on the other.

Colors

- Beechwood
- Buff
- Charcoal
- Natural

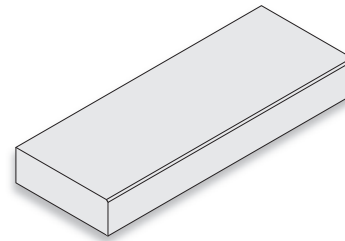

Size	Area	Weight	Units/Pallet	Pallet Weight
48 x 18 x 6" H	6.0 sq. ft.	409 lbs.	6 (32 sq. ft.)	2,504 lbs.

Stepping Stones

Silver Creek Stoneworks

- Strong, wet cast reproductions of handcrafted limestone originals
- 1.75" H, average 3.75 sq. ft. ea.
- Four unique shapes, chiseled edge
- Full pallets only, CANNOT be double stacked

Colors

- Bluestone
- Indiana Limestone
- Buff

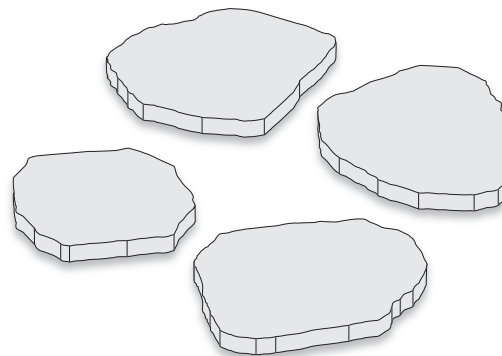

Sets	Weight	Sets/Pallet	Pallet Weight
5 each of 4 sets (20)	208 lbs.	5 (75 sq. ft.)	1,090 lbs.

Chiseled Caps and Tops

Silver Creek Stoneworks

• Available by pallet or piece

Colors

- Bluestone
- Indiana Limestone
- Buff

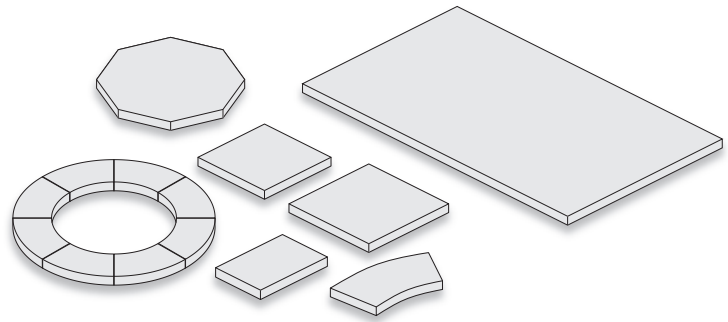

Name	Size	Face Area	Weight	Units/Pallet	Pallet Weight
25" Pillar Cap	25 x 25 x 2.25" H	4.34 sq. ft.	110 lbs.	6 (26.04 sq. ft.)	710 lbs.
30" Pillar Cap	30 x 30 x 2.25" H	6.25 sq. ft.	125 lbs.	6 (37.50 sq. ft.)	800 lbs.
12" Radius Seat Wall Cap	18.75 x 12 x 2.25" H	1.56 sq. ft.	39 lbs.	15 (23.40 sq. ft.)	635 lbs.
12" Straight Seat Wall Cap, 2-sided	24 x 12 x 2.25" H	2 sq. ft.	53 lbs.	15 (30 sq. ft.)	845 lbs.
12" Straight Seat Wall Cap, 3-sided	24 x 12 x 2.25" H	2 sq. ft.	53 lbs.	15 (30 sq. ft.)	845 lbs.
2-sided Bar Top	36 x 48 x 2.25" H	12 sq. ft.	327 lbs.	1 (12 sq. ft.)	377 lbs.
3-sided Bar Top	36 x 48 x 2.25" H	12 sq. ft.	327 lbs.	1 (12 sq. ft.)	377 lbs.
Octagon Top	36 x 36 x 2.25" H	-	238 lbs.	1	238 lbs.
Fire Ring Cap	10 W x 2.25" H	-	298 lbs.	-	-

CANNOT be double stacked.

Super-Stik Adhesive

Product	Item#	Details
10.5 oz. tube	1140001	12/case, 108 cases/pallet
29 oz. tube	1140002	12/case, 44 cases/pallet

Geo-Grid

Strata Systems

Product	Item#	Roll Size	Weight	Coverage
Strata Dealer Rolls	1178100	4 x 50'	-	22.22 sq. yd.
Strata 200	1178010	6 x 300'	95 lbs.	200 sq. yd.
Strata 350	1178300	6 x 300'	100 lbs.	200 sq. yd.

Sleeve-It

Strata Systems (pre-engineered fence post anchoring solution)

Product	Item#	Minimum	Pallet
Sleeve-It SD1	SI-1124R	5 units (1 pkg.)	45 units

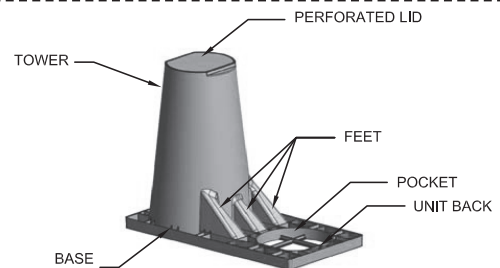

Snap-Edge Paver Restraint

SEK Surebond

Product	Item #	Details	Pallets
Paver Edge Restraint 8' piece	IESEPR96-672	24/bundle	28 bundles
Low Profile 6' 8"	ESELP80-672	24/bundle	28 bundles
10" spikes	SSBR10-150-048	150/box	48 boxes

Bullnose Paver

Interlock Concrete Products

- Smooth surface, full radius front
- Available by pallet or layer

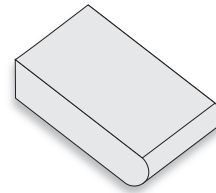

Colors

- Buff
- Brown
- Natural
- Onyx

Size	Face Area	Weight	Units/Layer	Layers	Units/Pallet	Pallet	Pallet Weight
12 x 6 x 2.375" H	0.50 sq. ft.	13.06 lbs.	48	3	144	72 sq. ft.	1,930 lbs.

Bullet Edger

Interlock Concrete Products

- Available by pallet



Colors

- Beechwood
- Buff
- Carmel
- Charcoal

Size	Unit In. ft.	Weight	Units/Layer	Layers	Units/Pallet	Pallet In. ft.	Pallet Weight
4 x 12.25 x 4" H	0.9375 In. ft.	14 lbs.	36	5	180	168.75 In. ft.	2,570 lbs.

To estimate number of units, divide In. ft. by 0.9375.

Classic Edger

Rockwood Retaining Walls

- Patented T-lock design helps prevent frost heave
- Available by pallet



Colors

- Brown
- Charcoal
- Gray
- Red/Black
- Sandstone

Size	Unit In. ft.	Weight	Units/Layer	Layers	Units/Pallet	Pallet In. ft.	Pallet Weight
4 x 10 x 2.75" H	0.83 In. ft.	9 lbs.	48	4	192	160 In. ft.	1,778 lbs.

Estimate the Classic Edger, divide lineal ft. by 0.83.

Tumbled Granite Edger

Rockwood Retaining Walls

- Smooth sides, split face, tumbled, available by pallet

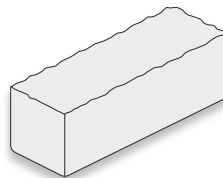

Colors

- Bluestone
- Desert (discontinued)
- Santa Fe

Size	Weight	Units/Layer	Layers	Units/Pallet	Pallet	Pallet Weight
12 x 4 x 4" H	16 lbs.	32	5	160	160 In. ft.	2,610 lbs.

Kitchen Cabinet Kits

Rockwood Retaining Walls

A collection of granite-topped cabinets for backyard baking, grilling, dining and entertaining. Elegant, functional and affordable, these quality components and cabinets are ready to assemble in any configuration you can imagine.

Features

- Easy-to-read, step-by-step instructions
- Premium stainless steel grills and components
- Concrete precut and reinforcements sized to fit
- VOC-compliant adhesive and gloves
- High-grade, 3cm Solid Granite Top Colors in Black Pearle or Viscon White

Cabinet Colors

- Beechwood
- Bluestone
- Desert
- Santa Fe

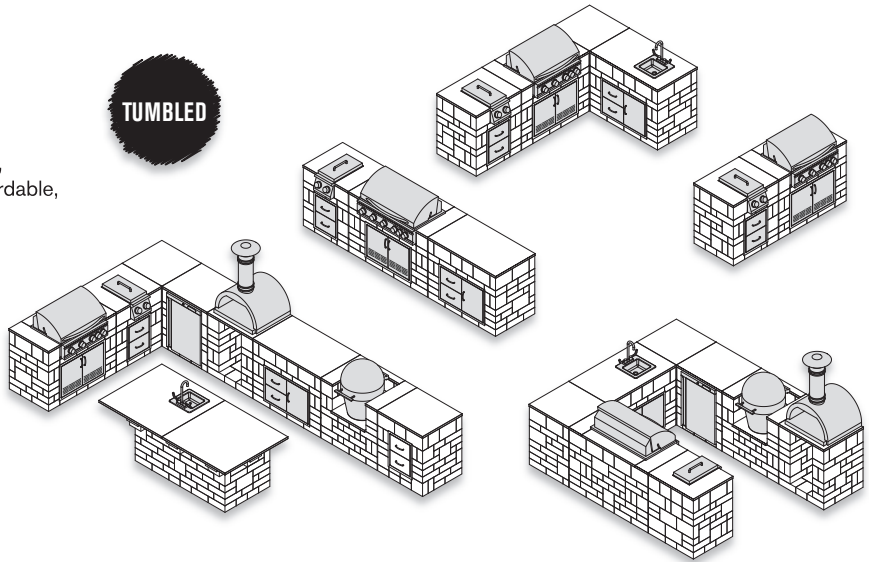

Full specifications available online at: www.kitchen.outdoorlivingkits.com

Kit	Size	Pallets	Weight	Build Time
40" Grill Cabinet (5 burner) Summerset Sizzler 40" Grill, 30" vented double doors, grill cover, 12,000 max Btu	56 x 28 x 37" H	2	2,890 lbs.	6 hrs.
32" Grill Cabinet (4 burner) Summerset Sizzler 32" Grill, 30" vented double doors, grill cover, 12,000 max Btu	48 x 28 x 37" H	2	2,535 lbs.	5 hrs.
Side Burner Cabinet #304 stainless steel construction. Push-to-turn knob ignition, easy-glide drawers, 30,000 Btu/hr solid brass burners. 19.5" x 10.5" cooking surface.	32 x 28 x 37" H	2	1,905 lbs.	4 hrs.
Prep Center Cabinet Double drawer/door combo.	48 x 28 x 37" H	2	2,270 lbs.	5 hrs.
Prep Center Cabinet w/Sink Double drawer/door combo, sink and fixture.	48 x 28 x 37" H	2	2,295 lbs.	6 hrs.
Refrigerator Cabinet (refrigerator sold separately*) *UL Certified for outdoor use. #304 stainless steel construction. 5.5 cu. ft. capacity, reversible door with lock and key, digital temperature display.	32 x 28 x 37" H	1	1,035 lbs.	4 hrs.
Two Drawer Cabinet Easy-glide stainless steel drawers. Fully enclosed stainless steel outside.	32 x 28 x 37" H	2	1,985 lbs.	5 hrs.
Trash Cabinet Easy-glide pullout drawer. Accommodates a 12-gallon trash can.	28 x 28 x 37" H	2	1,110 lbs.	3 hrs.
Smoker Cabinet (smoker not available or included)	40 x 28 x 37" H	1	2,120 lbs.	4 hrs.
Woodbox/Stand Cabinet	32 x 28 x 37" H	1	1,830 lbs.	4 hrs.
Outdoor Wood Fired Oven (Nonno Peppe) Sold separately. 24 x 24 cooking surface, color Hammered Copper.	30 x 32 x 40" H	1	155 lbs.	1 hrs.
Corner Cabinet	28 x 28 x 37" H	1	1,935 lbs.	4 hrs.
Island Cabinet Double drawer/door combo. Base size 65 W x 32.50" D.	90 x 45.5 x 37" H	4	4,320 lbs.	8 hrs.
Island Cabinet w/Sink Double drawer/door combo, sink and fixture.	90 x 45.5 x 37" H	4	4,335 lbs.	9 hrs.
Deluxe Rotisserie Kit (optional) #304 stainless steel, heavy-duty motor and 25 lb. capacity.				
Grill Cover (replacement)				

Build time assumes two people with limited skills and base work is complete prior to construction. **Kits cannot be returned.**



WARNING! Kits are not designed for commercial installations and applications.

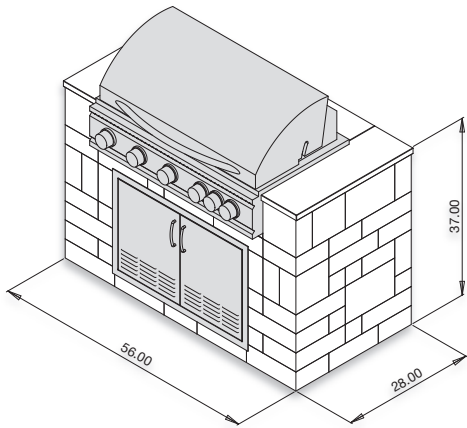

40" Grill Cabinet

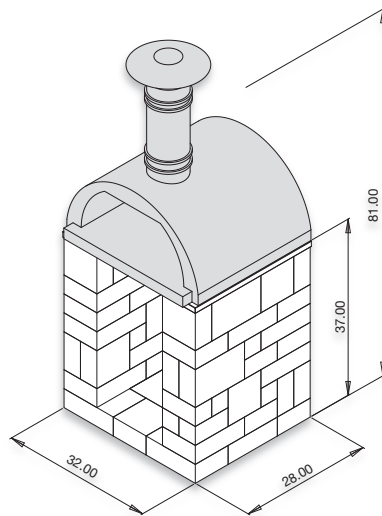

Wood-Fired Outdoor Oven Woodbox/Stand Cabinet

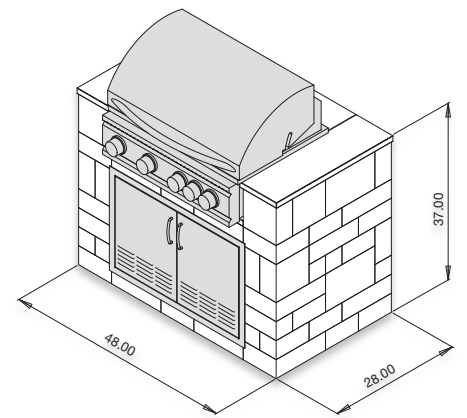

32" Grill Cabinet

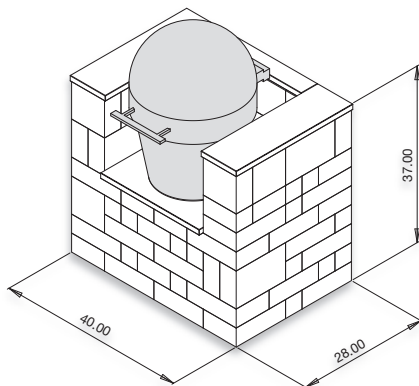

Smoker Cabinet
(Smoker not included)

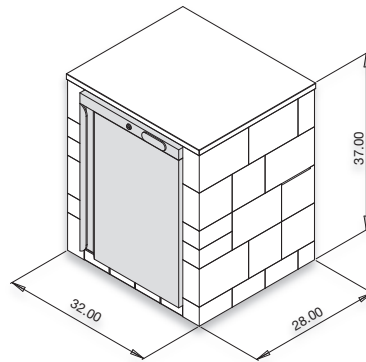

Refrigerator Cabinet
(Optional refrigerator)

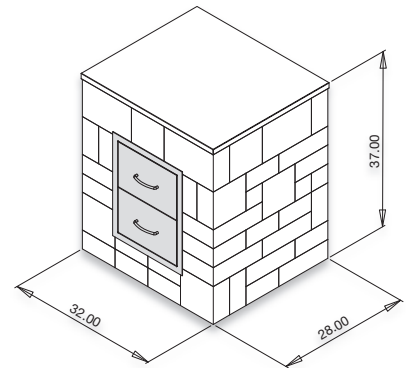

Two Drawer Cabinet

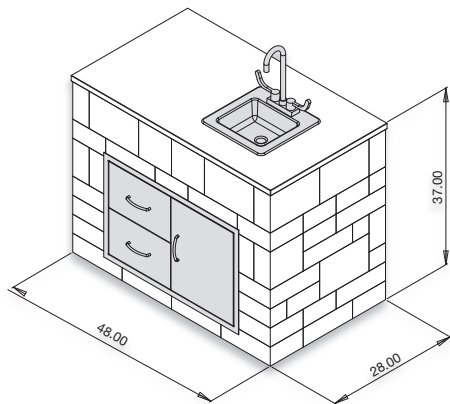

Prep Center Cabinet
(Optional sink)

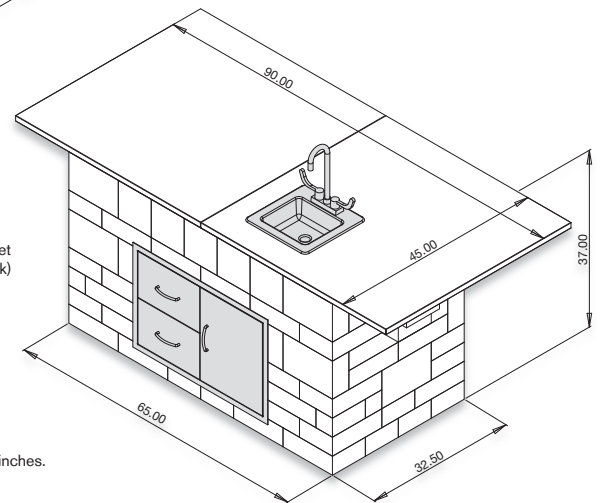

Island Cabinet
(Optional sink)

All dimensions shown in inches.

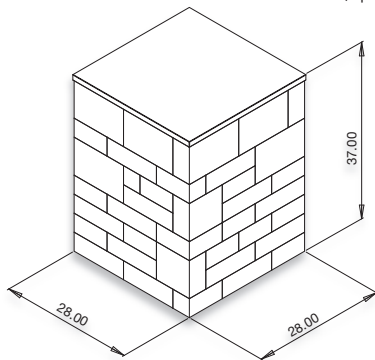

Corner Cabinet

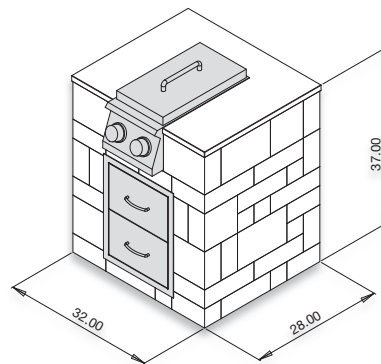

Side Burner Cabinet

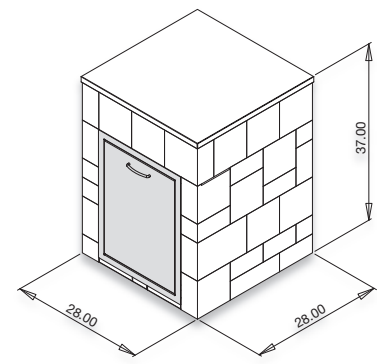

Trash Drawer Cabinet

Necessaries Outdoor Living Kits

Necessaries is a collection of affordable, ready-to-assemble outdoor fireplaces, island bars and grills, kitchens, tables, waterfalls, fire rings, seat walls and pillars kits.

Affordable luxury

Necessaries kits are both beautiful and functional, turning backyards into attractive and enjoyable outdoor living spaces. Also, Necessaries come ready-to-assemble with everything needed to build, making them easier to install and more affordable than typical masonry structures.

Easy to build

Each Necessaries Outdoor Living Kit comes complete with everything you need to build, including precut block sized to fit, reinforcements, adhesive, and easy-to-read, step-by-step instructions. Most kits can be built by two people in an afternoon, or less.

Expand anytime

You can build your project all at once or add new features over time. Because of Necessaries' modularity, expanding your outdoor living space is easy to do whenever you are ready.

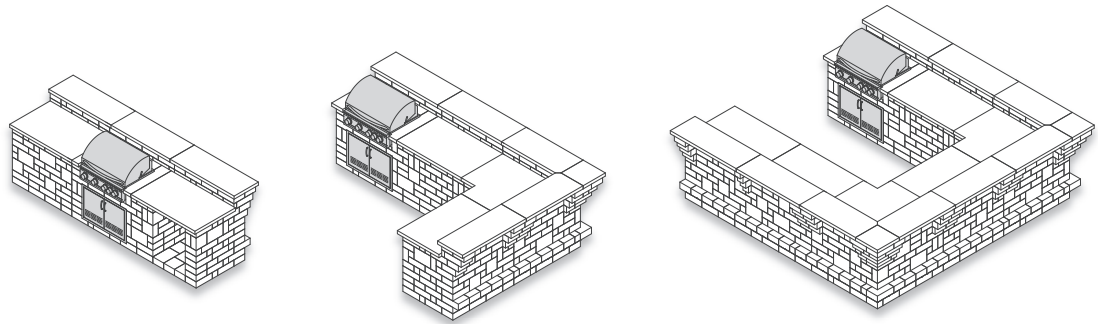

Earthy colors

Necessaries kits feature Rockwood Retaining Walls' multi-piece, tumbled Lakeland and Riverland wall systems in:

- Beechwood
- Bluestone
- Desert
- Santa Fe

Necessaries caps/tops are wet cast reproductions of handcrafted limestone originals. All tops, hearths and mantels come in Indiana Limestone (gray).

Standard Features

- NO CUTTING
- Easy-to-read, step-by-step instructions
- Premium stainless steel grills and components
- Mantels, tops and caps are cast from Indiana limestone originals
- Concrete precut and reinforcements sized to fit
- VOC-compliant adhesive and gloves

Grand Fireplace Kits

Rockwood Retaining Walls

Features

- Includes FMI Products 36" stainless steel, wood-burning insert, log rack and spark curtain. Adaptable for natural or LP gas.
- 4' stainless stovepipe chimney
- Spark suppressor cap
- Gas burner log set (optional)
- Optional **Grand Wood Box Kit** available left or right side
- Optional **Grand Hearth Kit**

Colors

- Beechwood
- Bluestone
- Desert
- Santa Fe

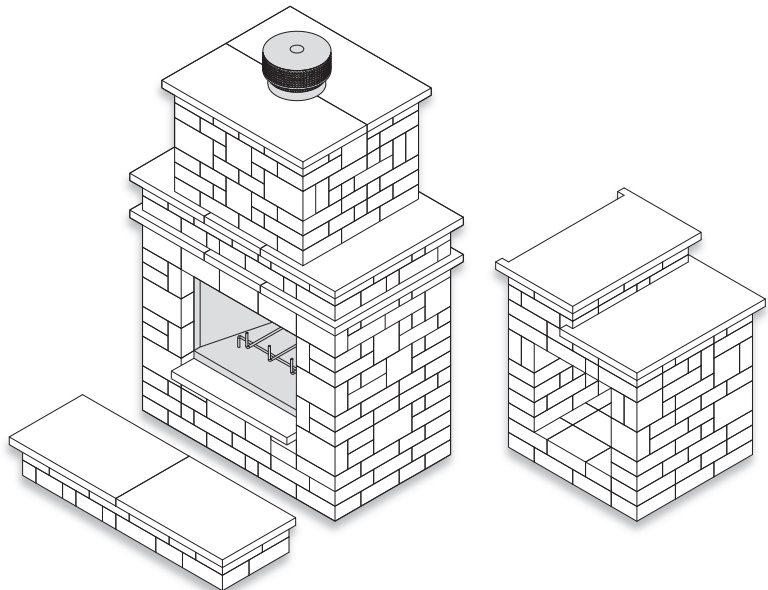

Grand Fireplace	Size	Pallets/Weight	Build Time
Fireplace (Interior: 33 W x 16 D x 19" H)	60 x 36 x 102" H	5 (9,677 lbs.)	8 hrs.
Hearth	60 x 20 x 10" H	1 (709 lbs.)	3 hrs.
Woodbox (Interior 24 W x 28 D x 24" H)	40 x 36 x 50" H	2 (4,061 lbs.)	1 hr.

Build time assumes two people with limited skills and base work is complete prior to construction. **Kits cannot be returned.**

Contemporary Fireplace Kits

Rockwood Retaining Walls

- Firegear stainless steel gas insert
- 43,000+ Btu/hr, natural gas or LP
- Electronic ignition
- Stainless steel rear access door
- Optional **Hearth Kit**

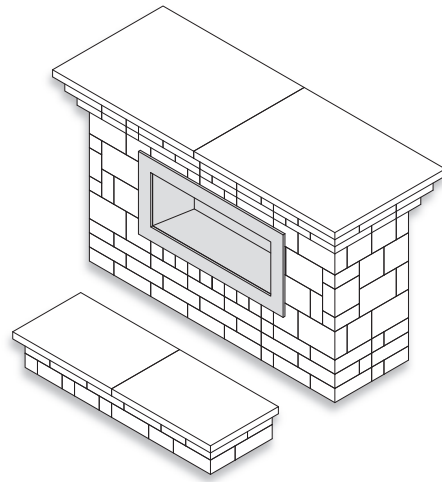

Colors

- Beechwood
- Bluestone
- Desert
- Santa Fe

Contemporary Fireplace	Size	Pallets/Weight	Build Time
Fireplace	96 x 36 x 54" H	5 (4,700 lbs.)	6 hrs.
Hearth	60 x 20 x 10" H	1 (709 lbs.)	1 hr.

Build time assumes two people with limited skills and base work is complete prior to construction. **Kits cannot be returned.**

Colonial and Compact Fireplace Kits

Rockwood Retaining Walls

- 2.25" fire brick protects block
- Optional **Woodbox Kit** available left or right side
- Optional **Hearth Kit**
- **Gas Burning Option***
 - NG or LP conversion kit, all connections and instructions
 - 2 burner, 52,000/49,000 max Btu's
 - 18" iron log rack
 - Arizona Weathered Oak ceramic log set

Compact

Colonial

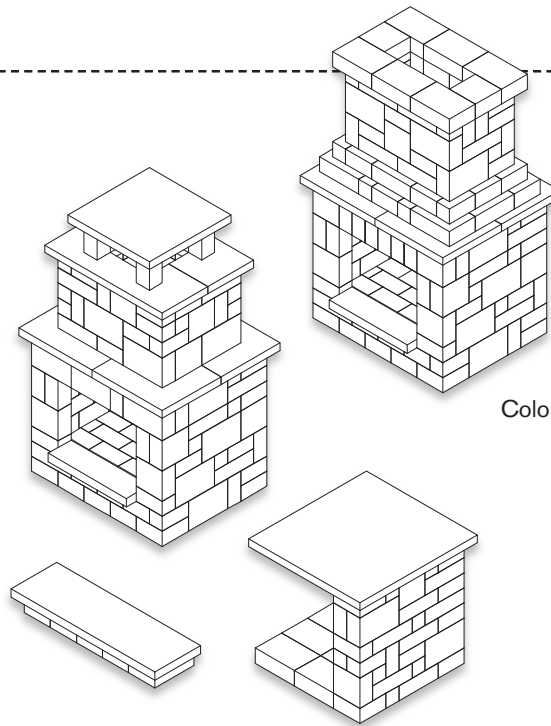

Colors

- Beechwood
- Bluestone
- Desert
- Santa Fe

Colonial Fireplace	Size	Pallets/Weight	Build Time
Fireplace (Interior: 29 W x 18.5 D x 26.5" H)	40 x 32 x 70" H	2 (4,360 lbs.)	3 hrs.
Hearth	40 x 12 x 6" H	1 (295 lbs.)	0.5 hr.
Woodbox (Interior: 24 W x 24 D x 28" H)	32 x 32 x 34" H	1 (1,665 lbs.)	1 hrs.

Compact Fireplace	Size	Pallets/Weight	Build Time
Fireplace (Interior: 29 W x 18.5 D x 26.5" H)	40 x 32 x 70" H	2 (3,735 lbs.)	3 hrs.
Hearth	40 x 12 x 6" H	1 (295 lbs.)	0.5 hr.
Woodbox (Interior: 24 W x 24 D x 28" H)	32 x 32 x 34" H	1 (1,665 lbs.)	1 hrs.

Build time assumes two people with limited skills and base work is complete prior to construction. **Kits cannot be returned.**

Victorian Fireplace Kits

Rockwood Retaining Walls

Features

- 2.25" fire brick protects block
- Optional **Woodbox Kit** available left or right side
- Optional **Hearth Kit**
- **Gas Burning Option***
 - NG or LP conversion kit, all connections and instructions
 - 2 burner, 52,000/49,000 max Btu's
 - 18" iron log rack
 - Weathered Oak ceramic log set

Colors

- Beechwood
- Bluestone
- Desert
- Santa Fe

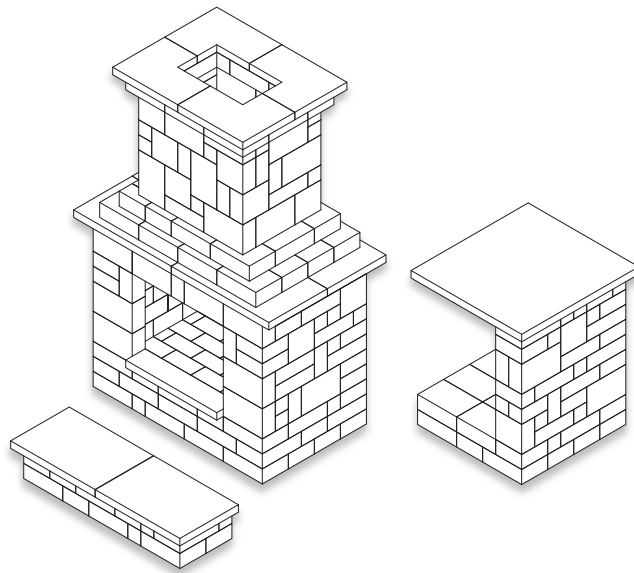

Victorian Fireplace	Size	Pallets/Weight	Build Time
Fireplace (Interior: 31 W x 17.5 D x 29.5" H)	52 x 32 x 89" H	5 (6,610 lbs.)	8 hrs.
Hearth	52 x 18 x 10" H	1 (580 lbs.)	1 hr.
Woodbox (Interior: 24 W x 24 D x 32" H)	32 x 32 x 42" H	2 (2,190 lbs.)	3 hrs.

Build time assumes two people with limited skills and base work is complete prior to construction. **Kits cannot be returned.**

Seat Wall and Pillar Kits

Rockwood Retaining Walls

a. 20" Pillar Kit

- 2.25" H chiseled cap

b. 20" Pillar with Glass Kit (lights not included)

- Pittsburgh Corning Premiere 8" glass block
- 2.25" H chiseled cap

c. 24" Pillar Kit

- 2.25" H chiseled cap

d. Lakeland Seat Wall Kit

- Creates a 6' straight wall
- Optional chiseled cap

e. Riverland Seat Wall Kit

- Creates an 8' radius wall
- Optional chiseled cap

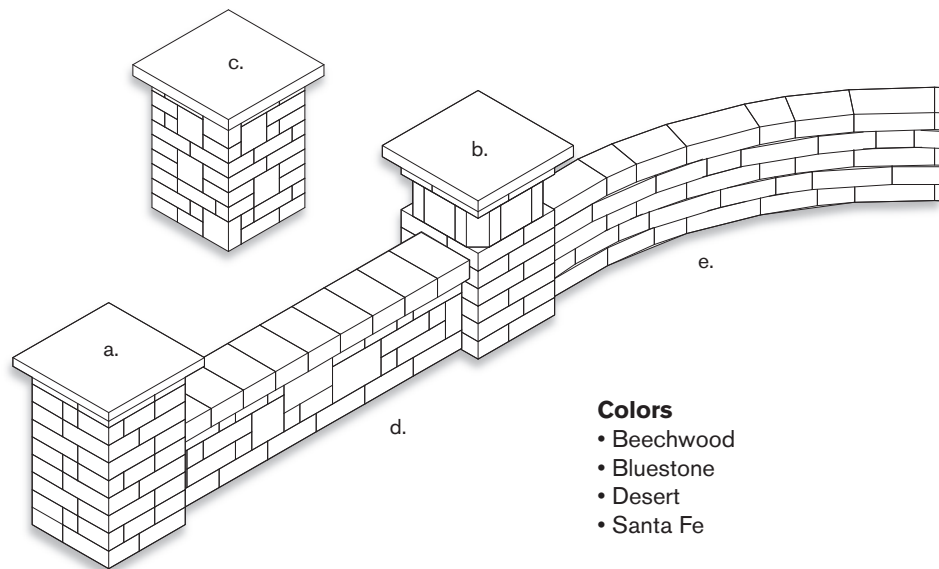

Colors

- Beechwood
- Bluestone
- Desert
- Santa Fe

Kit	Size	Pallets/Weight	Build Time
20" Pillar Kit (w/25 x 25 x 2.25" top)	20 x 20 x 38" H	1 (1,260 lbs.)	0.5 hr.
20" Pillar w/Glass (w/25 x 25 x 2.25" top)	20 x 20 x 38" H	1 (1,150 lbs.)	0.5 hr.
24" Pillar Kit (w/30 x 30 x 2.25" top)	24 x 24 x 39" H	1 (1,665 lbs.)	0.5 hr.
Lakeland Seat Wall Kit	72 x 8 x 20" H	1 (1,075 lbs.)	0.5 hr.
Riverland Seat Wall Kit	108 x 8 x 20" H	1 (1,400 lbs.)	0.5 hr.

Build time assumes two people with limited skills and base work is complete prior to construction. **Kits cannot be returned.**

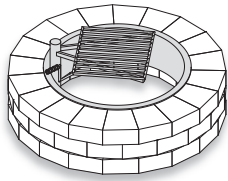

Grand Fire Ring

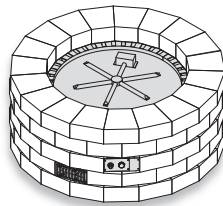

Grand Gas Fire Ring

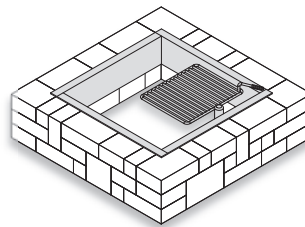

Victorian Fire Pit

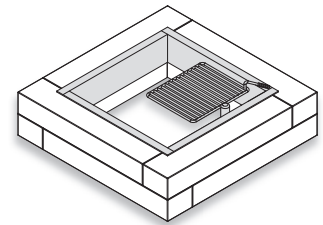

Barn Plank Wall Fire Pit

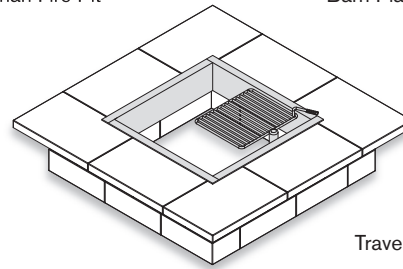

Travertine Wall Fire Pit

Fire Rings Kits

Rockwood Retaining Walls

Grand Fire Ring Kit Features

- One-piece, heavy gauge, 48" D x 12" H
Solid steel insert protects block (30.5" interior dia. x 8" H, 1.5" flang)
- Optional **Fire Ring Block Layer** – add layers to increase height
- Optional **Fire Ring Cap** – chiseled edge, eight-piece, in three colors, 2.25" H
- Optional **Swivel Cooking Grate** – removable, heavy steel construction, ADA compliant
- Optional **E-Z Access Spark Screen** – keep ash and sparks inside and debris out, hinged for easy access
- Optional **Cover** – heavy galvanized steel with or without cooking grate slot

Grand Gas Fire Ring Kit (Not suitable for commercial installations)

- Push-button electronic ignition
- 65,000 max Btu/hr, natural gas or LP
- Thermo-couple auto shut-off safety feature
- #304 stainless steel construction
- All connections and fittings preassembled
- 50 lbs. lava rock
- Optional **Fire Ring Cap** – chiseled edge, eight-piece, in three colors, 2.25" H
- Optional **Arizona Weathered Oak Log Set**



Victorian and Travertine Fire Pit Kits

- Four-piece, heavy gauge, solid steel insert protects block
- Optional **Swivel Cooking Grate**

Kit	Size	Pallets/Weight	Build Time	Details
Grand (block only)	48 x 12" H	1 (1,019 lbs.)	0.5 hr.	Without steel insert
Grand Fire Ring	48 x 12" H	1 (1,057 lbs.)	0.5 hr.	With steel insert
Grand Fire Ring	48 x 12" H	1 (1,085 lbs.)	0.5 hr.	With insert and swivel cooking grate
Grand (one layer)	48 x 4" H	1 (346 lbs.)	-	19 Lakeland Fire Ring Block
Victorian Fire Pit (block only)	48" W x 12" H	1 (1,285 lbs.)	0.5 hr.	Without steel insert
Victorian Fire Pit	48" W x 12" H	1 (1,310 lbs.)	0.5 hr.	With insert and swivel Cooking Grate
Grand Gas Fire Ring	48 x 20" H	1 (1,710 lbs.)	0.5 hr.	Natural Gas
Barn Plank Wall Fire Pit	48 x 12" H	1 (1,255 lbs.)	0.5 hr.	With steel insert
Barn Plank Wall Fire Pit	48 x 12" H	1 (1,525 lbs.)	0.5 hr.	With steel insert and swivel cooking grate
Travertine Wall Fire Pit*	64 x 64 x 13.875" H	1 (1,900 lbs.)	0.5 hr.	With steel insert
Travertine Wall Fire Pit*	64 x 64 x 13.875" H	1 (1,930 lbs.)	0.5 hr.	With steel insert and swivel cooking grate

* Two block courses with 12 x 24 tiles (cap)

Build time assumes two people with limited skills and base work is complete prior to construction. **Kits cannot be returned.**

Options/Accessories	Size	Weight	Details
Fire Ring Cap (Cannot be double stacked)	10 W x 2.25" H	298 lbs.	In Indiana Limestone, Bluestone, or Buff.
Grand Cover	37.9 dia. x 2.88" H	27 lbs.	Heavy galvanized steel
Grand Cover w/Slot	34.9 dia. x 1.88" H	27 lbs.	Heavy galvanized steel, slotted for swivel cooking grate
Grand Swivel Cooking Grate	19.25 x 17.5 x 2" H	10 lbs.	300 sq. in. ADA approved swivel cooking grate, removable
Grand Steel Ring Insert	33.5 x 33.5 x 8.5" H	34 lbs.	Solid 10-gauge steel with 1" top lip, boxed
E-Z Access Spark Screen	40 x 18" H	22 lbs.	Hinged spark screen
LP Gas Conversion Kit			O-Ring conversion to LP
AZ Weathered Oak Gas Log Set	16" H	36 lbs.	9 pc. 16" height of log stack
Victorian Swivel Cooking Grate	19.25 x 17.5 x 2" H	10 lbs.	300 sq. in. ADA approved swivel cooking grate, removable
Victorian Steel Insert	33.5 x 33.5 x 8.5" H	34 lbs.	Solid 10-gauge steel with 1" top lip, boxed

Grand Island Bar Series

Rockwood Retaining Walls



a) Grand Island Bar/Grill with Storage Kit*

- Summerset Sizzler 32" grill
- Stainless steel double doors - vented

b) Grand Island Bar/Grill with Refrigerator Opening Kit*

- Summerset Sizzler 32" grill
- Stainless steel double doors - vented
- Optional Refrigerator (24" x 36" x 28" H opening)

c) Grand Island Bar 8' Kit

d) Grill Surround Kit

- For standing grills, 60" opening

e) Corner Return Kit***

- Makes L-shaped bar/grill

f) Bar Section 4' Kit**

- Left or right facing

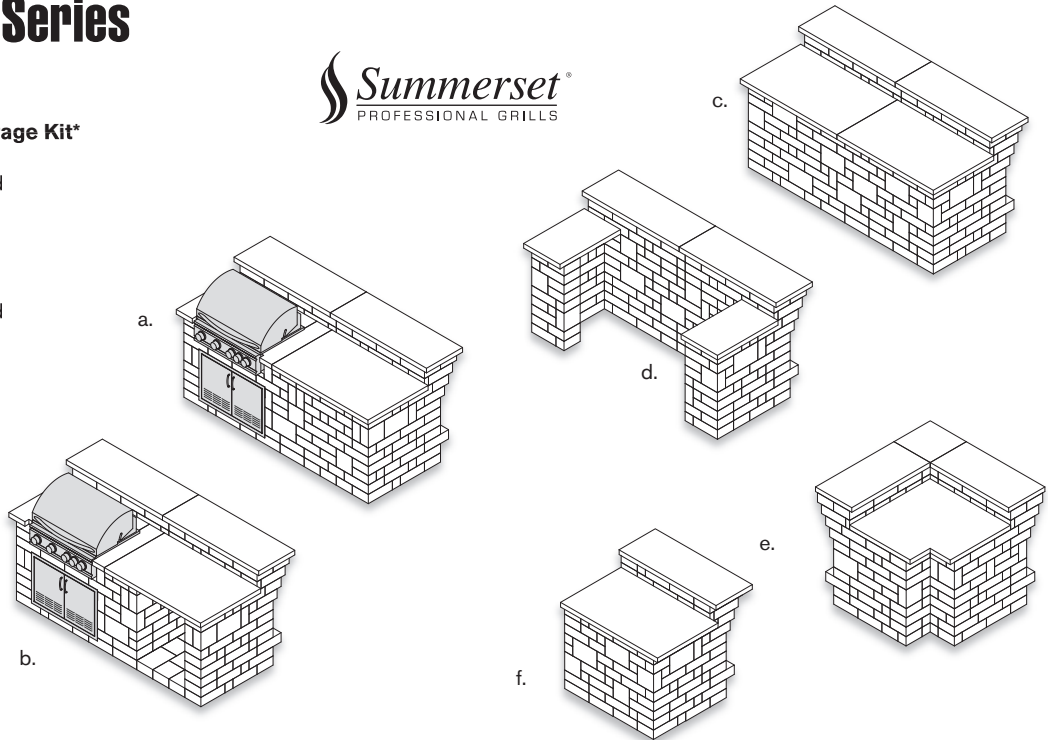

Colors

- Beechwood
- Bluestone
- Desert
- Santa Fe

Name	Size	Pallets/Weight	Build Time	Details
Grand Island Bar	96 x 48 x 46" H	3 (7,271 lbs.)	6 hr.	
Grand Island Bar w/Grill & Storage*	96 x 48 x 46" H	4 (7,341 lbs.)	7 hr.	w/32" grill
Grand Island Bar w/Grill & Refrigerator Opening	96 x 48 x 46" H	4 (7,341 lbs.)	7 hr.	w/32" grill
Grand Island Grill Surround	96 x 48 x 46" H	2 (4,915 lbs.)	4 hr.	Fits 60" freestanding grill
Bar Section 4' Section**	48 x 48 x 46" H	1 (3,780 lbs.)	4 hr.	
Grand Island Bar Corner Return***	48 x 48 x 46" H	2 (5,140 lbs.)	6 hr.	

*Please designate LP or NG grill at time of order. ** Must specify left side or right side when ordering.

*** Corner return edges are not finished, cannot use alone.

Build time assumes two people with limited skills and base work is complete prior to construction. **Kits cannot be returned.**

Bistro Table, Dining Table and Compact Bar Kits

Rockwood Retaining Walls

Colors

- Beechwood
- Bluestone
- Desert
- Santa Fe

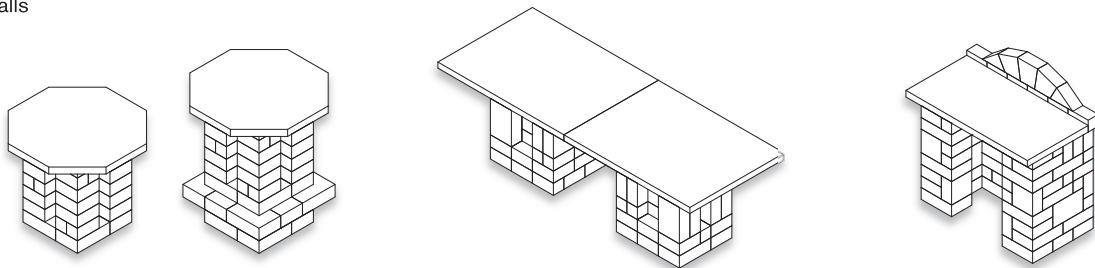

Name	Size	Pallets/Weight	Build Time	Details
Pub/Bistro Table	36 x 36 x 42" H	1 (1,515 lbs.)	1 hr.	Also builds 30" H Bistro Table
Compact Bar	48 x 24 x 38" H	1 (2,830 lbs.)	2 hrs.	Build open or closed front
Dining Table	36 x 96 x 30" H	1 (2,870 lbs.)	2 hrs.	Seats eight

Build time assumes two people with limited skills and base work is complete prior to construction. **Kits cannot be returned.**

Wood-fired Outdoor Pizza Oven

Rockwood Retaining Walls

Features

- 32 x 30 x 40" H
- 24 x 24" cooking surface
- Handcrafted in Sicily
- #304 stainless steel construction
- Reinforced, stainless steel chimney pipe
- Stainless steel interior wood caddy
- Stainless steel door
- °C and °F Thermometer
- Optional cover
- Color: Hammered Copper
- Weight: 155 lbs.

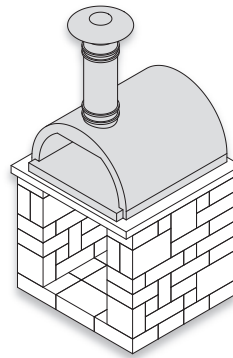

Silver Creek Top

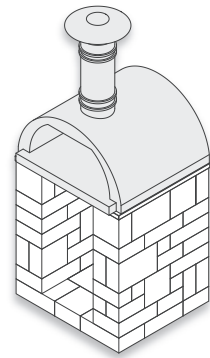

Granite Top

Outdoor Oven Woodbox/Stand Kits

Silver Creek Top	36 x 32 x 34" H	1 Pallet: (7,271 lbs.)	Build Time: 1 hr.
Granite Top (Kitchen Kit)	32 x 28 x 37" H	1 Pallet: (7,271 lbs.)	Build Time: 1 hr.

Oven sold separately. **Cannot be returned.**

Oven Toolkit Set

These Italian made cooking tools for wood-fired ovens will be appreciated for their ease of use and lasting quality. Each handle features a loop for hanging.

- Large rounded peel has a 11.5 x 12" head and a 45" reach
- 7" dia. peel has stainless handle, stay-cool plastic grip with unique sliding handle feature
- 6.5 x 2" W oven brush has brass bristles, aluminum handle with a 43" reach
- Sold as a three piece set

Cannot be returned.



Waterfall Kits

Rockwood Retaining Walls

Grand Waterfall Kit

- 1,350 gph mag drive pump
- 48" half-round basin
- 23" stainless steel spillway
- Optional LED light kit; blue or white

Compact Waterfall Kit

- 850 gph mag drive pump
- 26" square basin
- 11" stainless steel spillway
- Optional LED light kit; blue or white

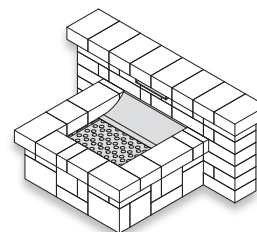
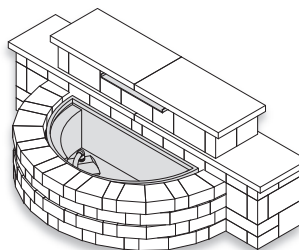

Waterfall kits include all plumbing/connections.
Colors: Beechwood, Bluestone, Desert, Santa Fe

Name	Size	Pallets/Weight	Build Time
Grand Water Feature	98" x 48" x 32" H	3 (3,475 lbs.)	4 hrs.
Compact Water Feature	64" x 40" x 28" H	1 (1,660 lbs.)	3 hrs.

Build time assumes two people with limited skills and base work is complete prior to construction. **Kits cannot be returned.**

All dimensions shown in inches.

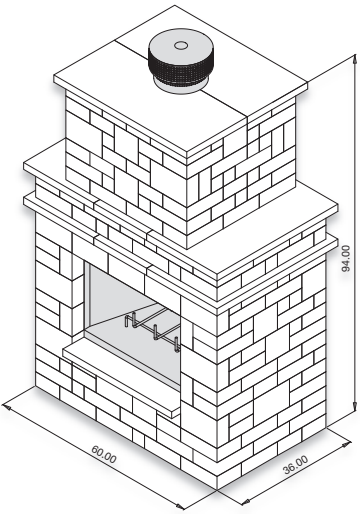

Grand Fireplace

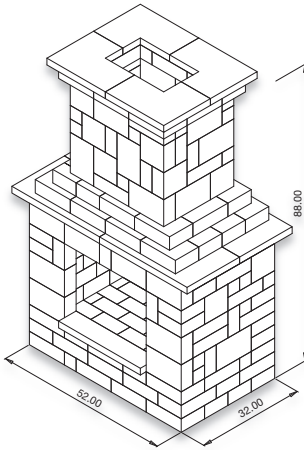
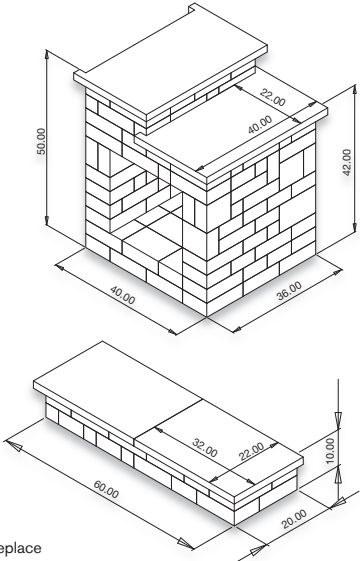

Victorian Fireplace

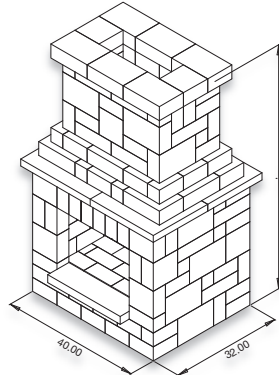
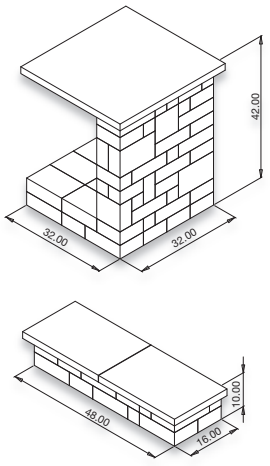

Colonial Fireplace

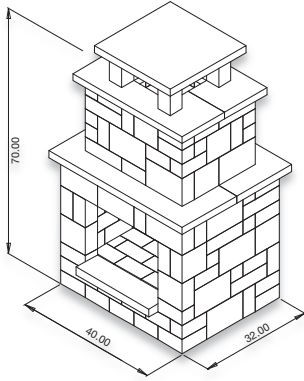
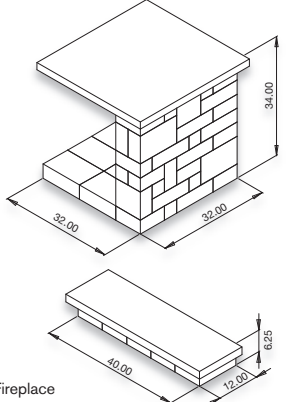

Compact Fireplace

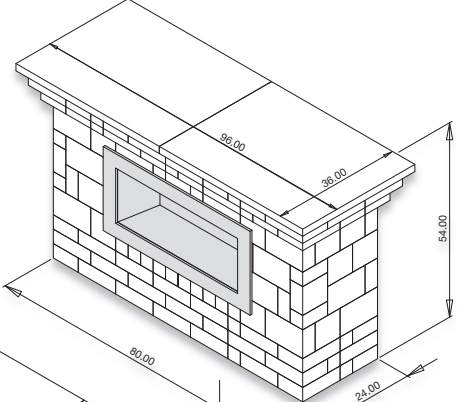
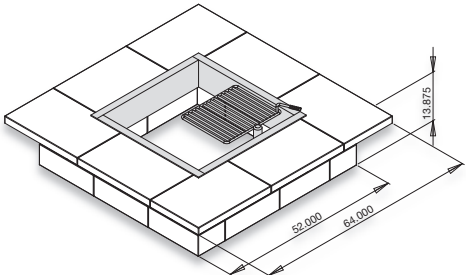
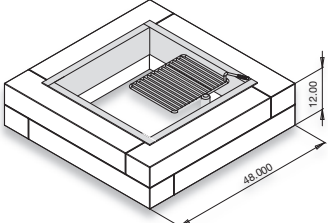
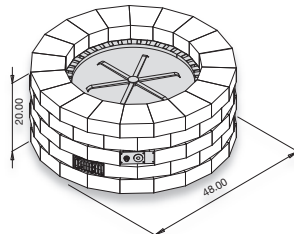
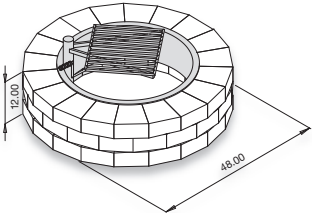
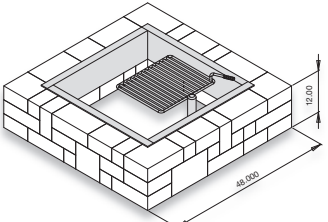
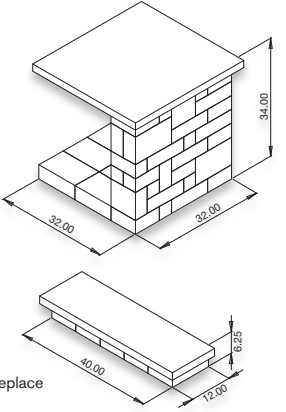

Contemporary Fireplace

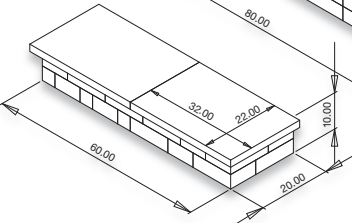
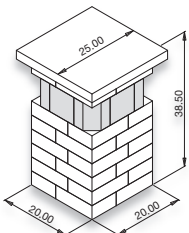
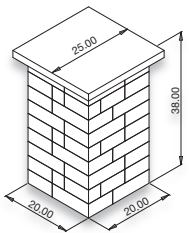
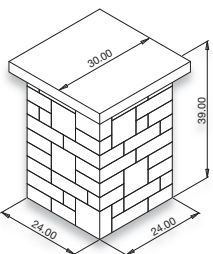

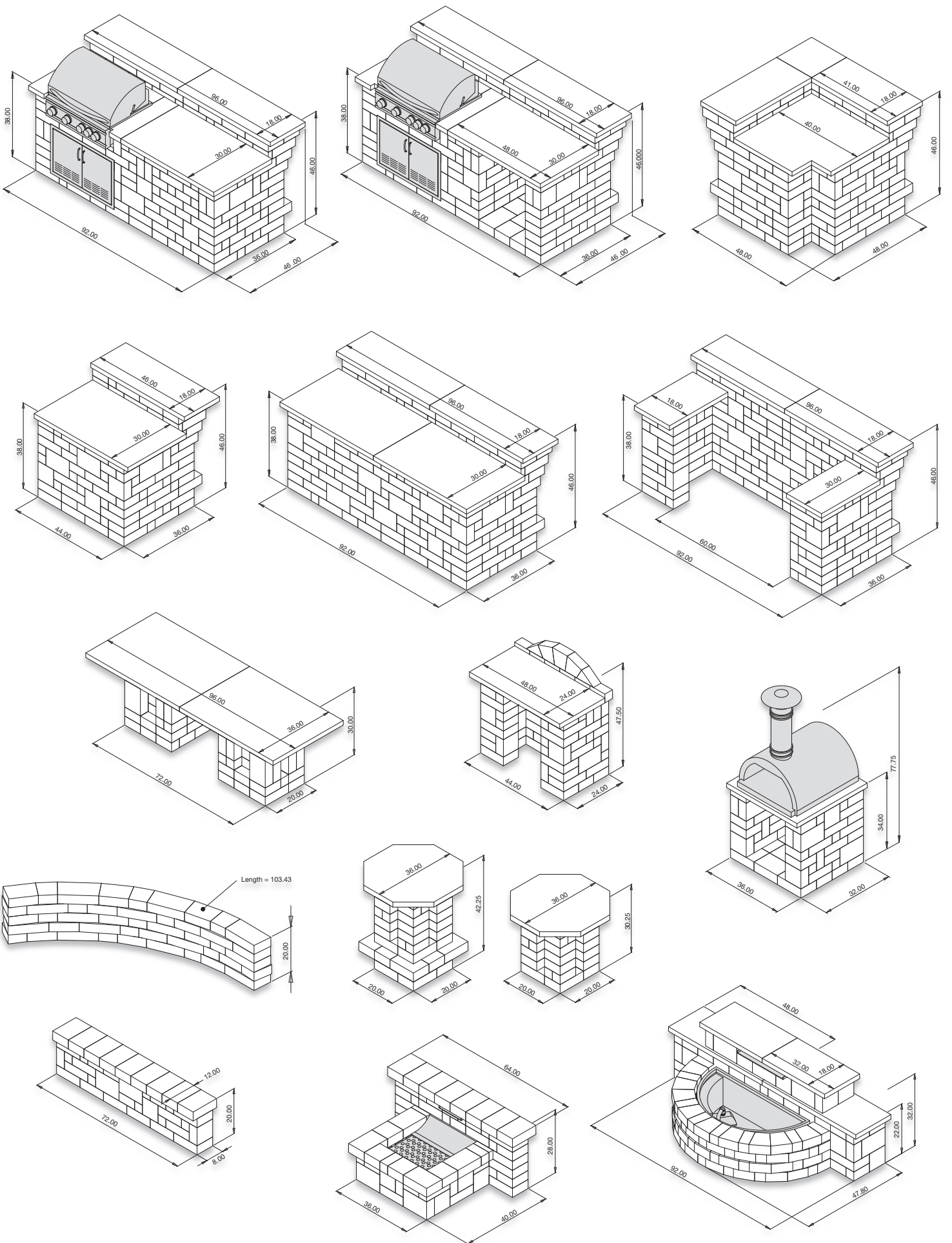

Calculating Paver Materials

Use the following methods to estimate the amount of materials you will need for your project.

EXCAVATION DEPTH GUIDE

Gravel Base: Use minimum depths in a well-drained area or undisturbed soil. Use maximum depths in poorly drained area or disturbed soil. 1/2" less is required to compensate compacting of pavers. If soil is saturated more than 50% of the time, filter fabric and extra base should be used.

	Pedestrian Traffic	Light Vehicular Traffic
Pavers	2-3/8"	2-3/8"
Sand	1"	1"
Gravel Base (compacted)	4" - 6"	8" - 12"
Total Excavation Depth	7" - 9"	11" - 15"

BASE MATERIAL CALCULATOR

Granular Base:

Square Footage of Pavers x (depth of base ÷ 12) ÷ 27 = Cubic Yards of Base Needed

Bedding Sand (1" depth):

Square Footage of Pavers x 0.0031 = Cubic Yards of Sand Needed

EDGE RESTRAINT CALCULATOR

Length of restrained pavers (ft.) ÷ 8 = Pieces of SnapEdge

Note: Use one spike for every foot of retained pavers.

CALCULATE BORDERS AND ACCENTS

Length of Border (ft.) ÷ Length of Product (ft.) = Number of units

Example: Cobble Stone Border

$$\frac{30}{\text{Length of Border (ft.)}} \div \frac{0.83}{\text{Length of Product (ft.)}} = \frac{36}{\text{Number of units}}$$

Discontinued products available
until gone, call for availability.



Calculating Retaining Wall Material Requirements

Use the following methods to estimate the amount of base material, drainage rock, and adhesive you will need for your project.

BASE MATERIAL CALCULATOR

A typical trench is 2' wide and 14" deep to bury a full course of 8" block. Your base material must be a minimum of 6" in height.

$$\frac{\text{Wall Length in ft.}}{\text{Base Height in ft.}} \times \frac{\text{Base Width in ft.}}{27} = \text{Cubic Yards}^*$$

*Add 10% for inconsistencies in the trench and compaction.

DRAINAGE ROCK CALCULATOR

You need enough drainage rock to fill 1' behind the tail of the block and to fill any cores.

$$\frac{\text{Wall sq. ft.}}{1.33} \times 27 = \text{Cubic Yards}$$

ADHESIVE CALCULATOR

The amount of adhesive required depends on type of block and construction. Use the guide below to estimate the amount of adhesive required.

Approximate length of bead by width:

Tube Size	Bead Widths/Tube		
	1/8"	1/4"	3/8"
10.5 oz.	129 ft.	32 ft.	14 ft.
29 oz.	355 ft.	89 ft.	39 ft.

Packaging	Tubes	
	10.5 oz.	29 oz.
Tubes/Case	12	12
Cases/Pallet	108	44

ONLINE HARDSCAPES CALCULATOR

Quickly and easily calculate paver and materials requirements from your desktop or mobile device. Send yourself a PDF of the results for your project planning.

Go to: www.rochestercp.com/estimator/

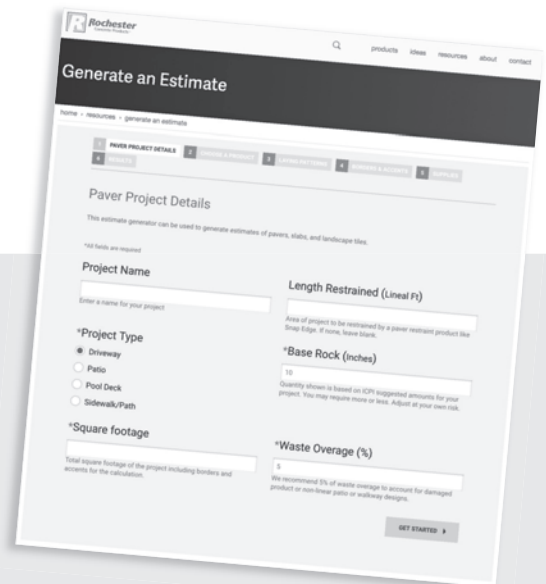

Classic 6 & 8 Walls - 20" Pillar

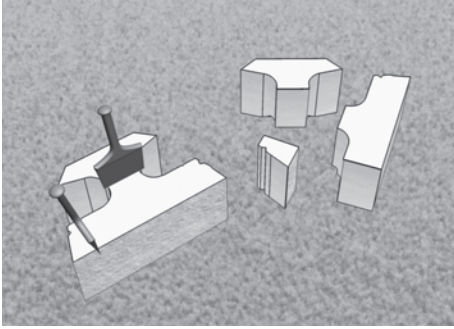

Step 1 - Create a (Corner) Pillar Block
If you need to create corners on the job site, see instructions on previous page on how to create Corner Blocks.

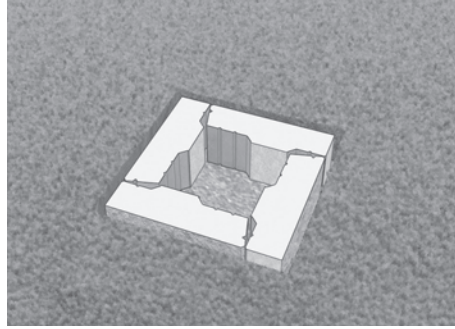

Step 2 - Excavating and Site Preparation
Follow the steps for a leveling pad installation, as described in basic wall installation. Lay the first four pillar blocks with the split faces exposed to create the foundation for the 20" Pillar.

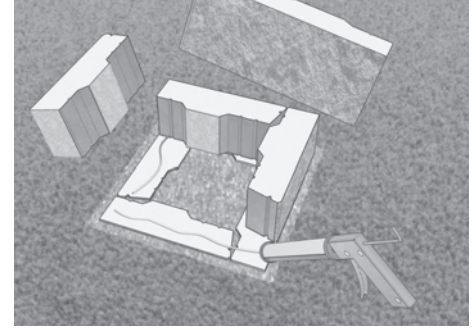

Step 3 - Successive Course Installation
Stagger the pillar blocks so a running bond is maintained. Adhere all blocks with Super-Stik™.

Classic 6 & 8 Walls - Half-Block Pillar

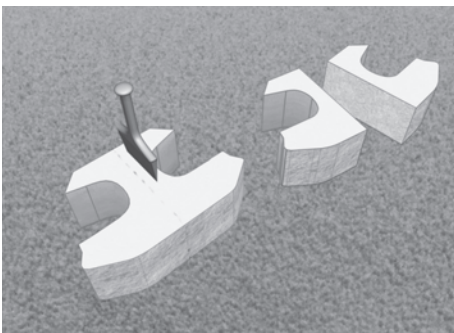

Step 1 - Create a Half Block
If you need to create Half Blocks on the job site, be sure you have Base Block.

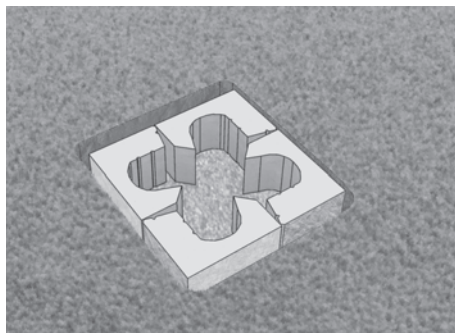

Step 2 - Excavating and Site preparation
Follow the steps for a leveling pad installation, as described in basic wall installation. Lay the first four Half Blocks with the split faces exposed to create the foundation for the Half Block Pillar.

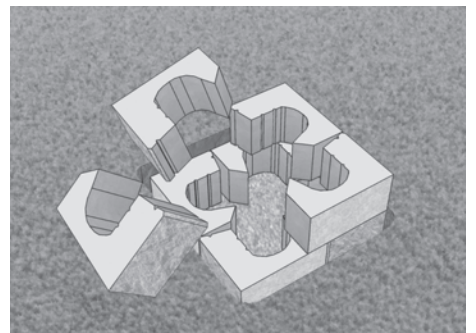

Step 3 - Successive Course Installation
Stagger the Half Blocks so a running bond is maintained. Adhere all blocks with Super-Stik™.

Classic 6 & 8 Walls - 90° Corners

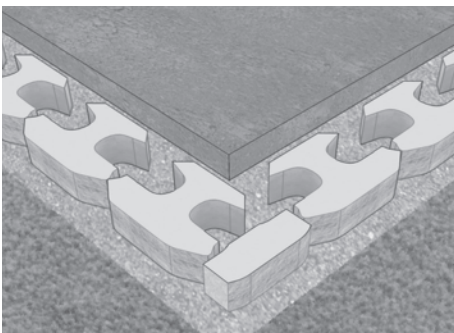

Base Course Preparation with Corner Block
Begin an **outside corner** from the corner of the wall and install the blocks from the corner out when possible.

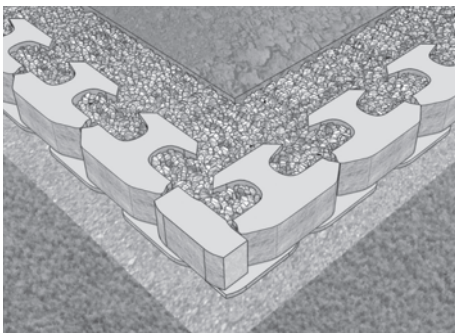

Successive Course Installation
Stagger the Corner Block as each successive course is installed so it is on the opposite side of the wall corner. Length adjustments to the Corner Block may be necessary to maintain a running bond.

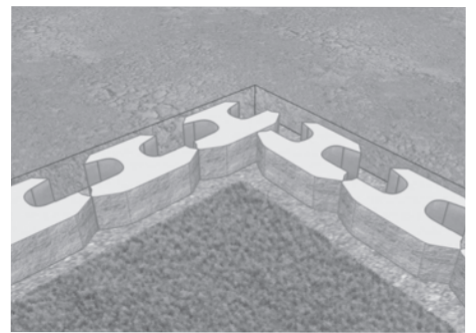

Base Course Preparation
Begin an **inside corner** from the corner of the wall and install the blocks from the corner out when possible. Only half of a whole block installed on the corner will be exposed. This is true of each successive block that is staggered in the corner.

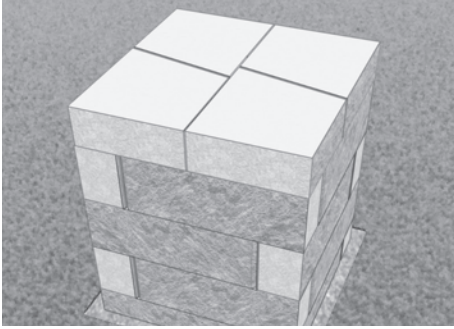

Step 4 - Capping a 20" Pillar

A 20" Pillar may be capped with Universal Caps, stone, or other prefabricated products. Adhere caps with Super-Stik™.

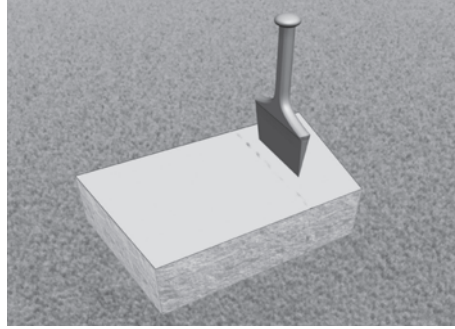

Creating a Pillar Cap Block

Pillars may be capped with 20" Universal Caps, stone or other prefabricated products. Adhere caps with Super-Stik™.

ROCKWOOD®
RETAINING WALLS
A better way.™

Adjusting Setback for Near Vertical Walls

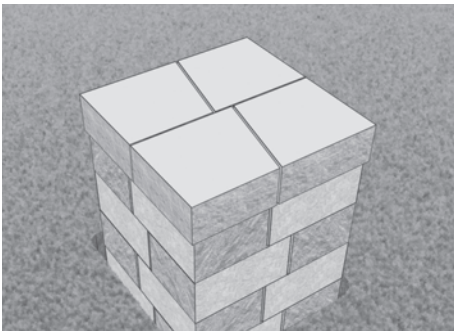

Step 4 - Capping a Half Block Pillar

A Half Block Pillar may be capped with Universal Caps, stone or other prefabricated products. Adhere caps with Super-Stik™.

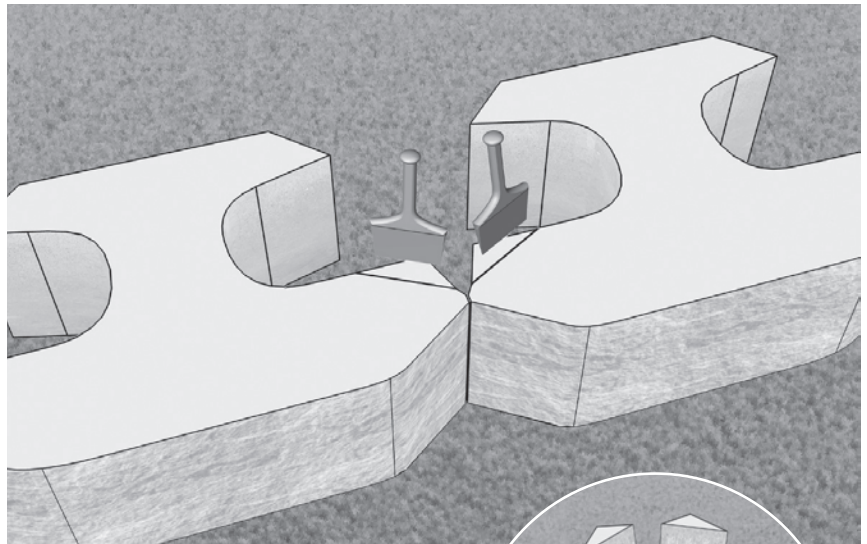

Rockwood blocks offer the unique ability to modify the facing batter of a wall. This is especially useful in stair step and egress window applications. For 6" tall Blocks, adjust setback by 3/4". For 8" tall Blocks, adjust setback by 1". The setback is determined by how much material is removed.

To adjust the setback, modify the two blocks below the successive course by splitting at the grooves on the top of each block. NEVER ALTER THE ANCHOR BAR! Doing so will adversely affect the performance of the wall.

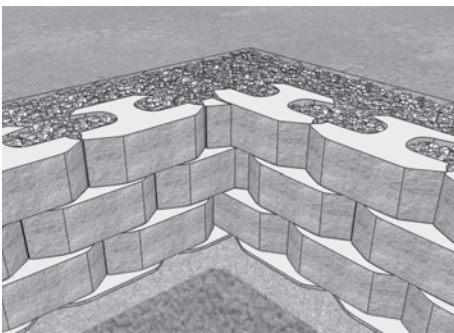

Successive Course Installation

Gaps will develop in successive courses, which will require a "wedge" block to fill the gap. Measure the gap and cut a block to fill the gap. Adhere cut block with Super-Stik™. Depending on the height of the wall, the "wedge" block will eventually become the same size as a whole block, then the process repeats itself.

Note: For complete retaining wall installation instructions, request a copy of the manual for the block system you are building with.

Available online at: www.rochesterpc.com/install

Classic 6 & 8 Walls - Half, Base and Corner Blocks

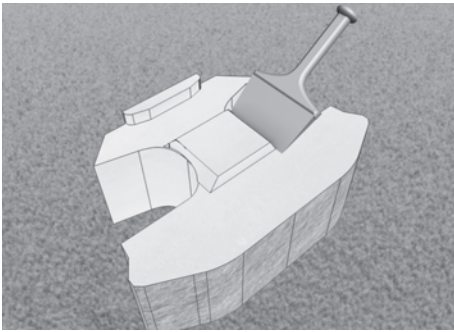

To create a Base Block, position the block so the Anchor Bar is facing up. Remove the Anchor Bar with a hammer and chisel as shown – wear protective equipment when modifying the block.

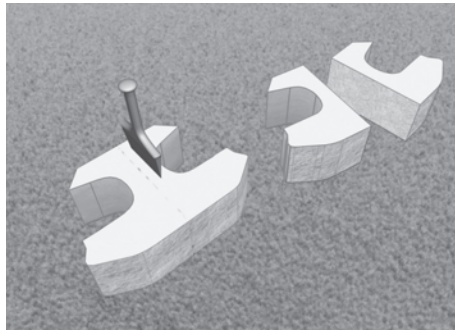

To create a Half Block, make a score line in the middle of the block, from front to back and on both sides. Split as shown. Wear protective equipment when splitting.

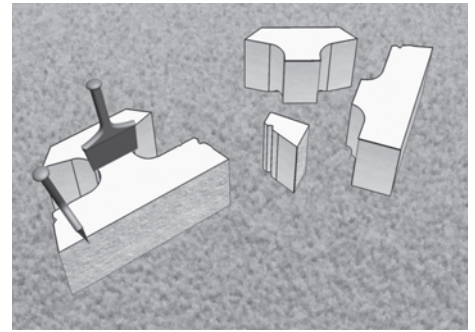

To create a Corner Block, make score lines on both splitting grooves and behind the head of the block. Split the block on both top and bottom sides, as shown. A hammer and chisel, or a hand splitter may be used to create the block. Wear protective equipment when splitting.

Classic 6 & 8 Walls - Basic Installation

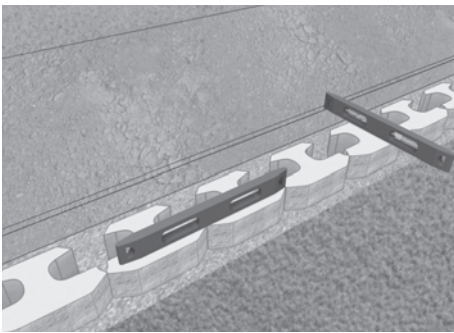

Base Course Installation

The base course will consist of base block. Use a string line behind the tail of the block for alignment on straight wall applications. All blocks should rest firmly on the pad and be centered to allow 6" of base material in front and 6" behind the Base Block. Level each block, side-to-side, front-to-back and across three full blocks with a hand level. A rubber mallet may be used to level and align the blocks.

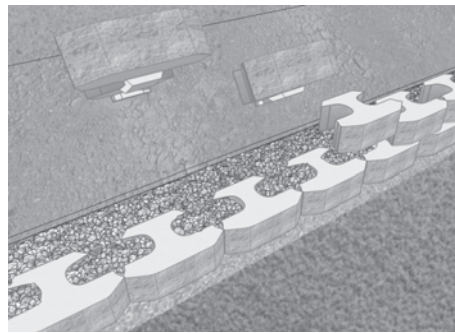

Core and Drainage Fill

Place 3/4" to 1" clean aggregate (crushed rock) within the cores and a minimum of 12" behind the blocks. This creates a drainage zone and Stone Columns that helps to unify and maximize the performance of the wall.

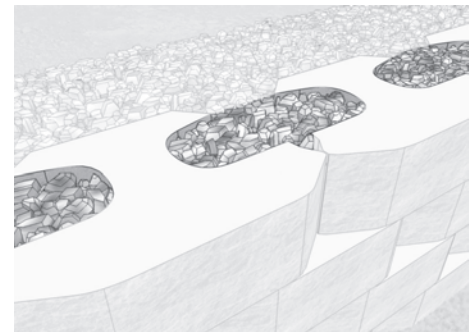

"Stone Columns" are an integral part of a Rockwood Retaining wall; adding support and stability to the wall.

Classic 6 & 8 Walls - Stepping a Wall

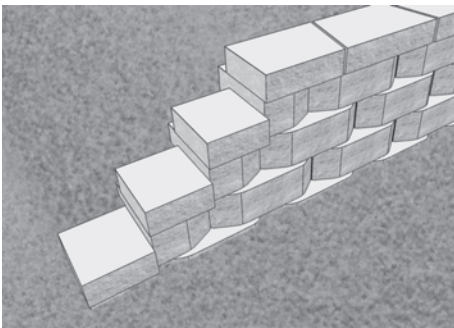

A Half Block or Corner Block may be used to end a course in a Rockwood application.

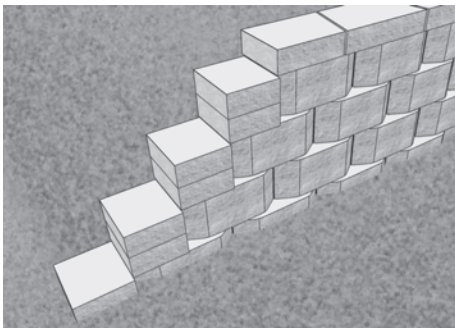

Double stack 4" tall Universal Caps as an end cap to finish courses of 8" tall blocks.

ROCKWOOD[®]
RETAINING WALLS
A better way.[™]

Vintage 6 Wall - Basic Installation

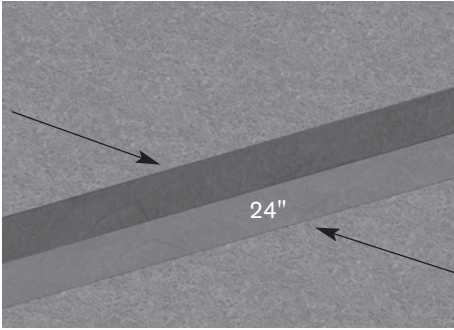

Note: Vintage 6 Garden Walls may be built to a maximum total height of 36" (under ideal conditions) without geogrid. Use a minimum 6" embedment and 12" of clean crushed rock behind wall.

Step 1 - Base Course Preparation

Beginning at the wall's lowest elevation, excavate a trench down the length of the wall with a minimum width of 24" to accommodate at least 6" of base material and 6" of block embedment. As a rule of thumb, for every 8" to 10" of wall height, 1" of block should be buried with a minimum of 6" base course embedment. Step the trench up or down with respect to adjacent grade.

Step 2 - Leveling Pad Installation

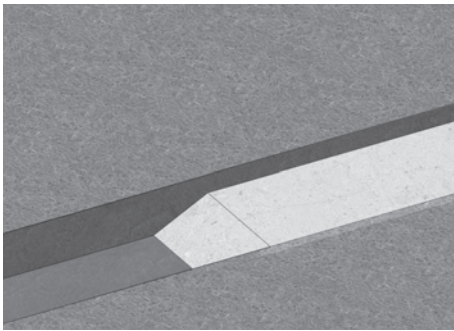

Note: Unlike other wall systems, Vintage builds vertically with no setback. For this reason, take extra caution to make sure the first course is level from front to back to prevent tipping or overturning.

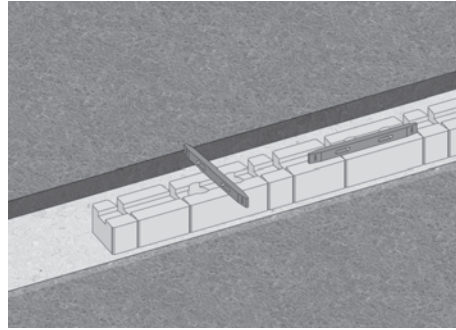

Step 3 - Base Course Installation

The base course will consist of Vintage all three blocks. Use a string line for alignment on straight wall applications. All blocks should rest firmly on the pad and be centered on the base to allow approximately 6" of base area in front and behind the block. Level each block side-to-side, front-to-back, and across three blocks with a hand level. A rubber mallet may be used to level and align the Vintage blocks.

Note: For best alignment results on straight walls use the string line within the interlocking channel.

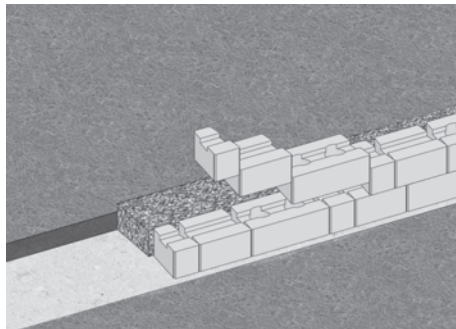

Step 4 - Drainage Fill

Place 3/4" to 1" clean aggregate (crushed rock) a minimum of 12" behind the blocks. This creates a drainage zone that helps to unify and maximize the performance of the wall.

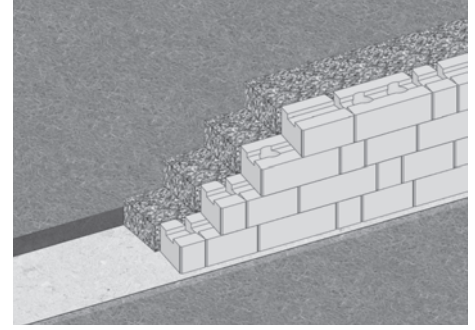

Step 5 - Continue to build courses

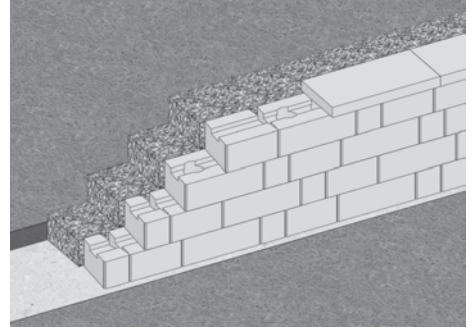

Capping a Wall

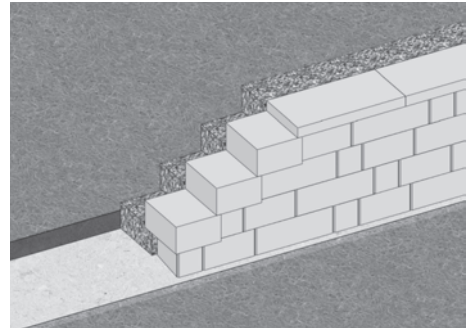

Ending a Wall - Step the end of your exposed wall with Vintage 6 corner block.

When building under 3' in height, place and compact a minimum of 6" base material to 95% Standard Proctor. Verify the base is level with a transit or hand level. Be aware the base material (commonly referred to as road base or base aggregate) will vary from region to region.

When building over 3' in height, it is highly recommended to build on a 2° inclined base (a 7/8" - 1" setback). Simply place 1" of material on top of your compacted leveling pad. Screed the excess material away using a level tied to an angled board, compact to 95% std. proctor.

Walls 36" and above need to be built with geosynthetic reinforcement and may need to be designed by a licensed engineer.

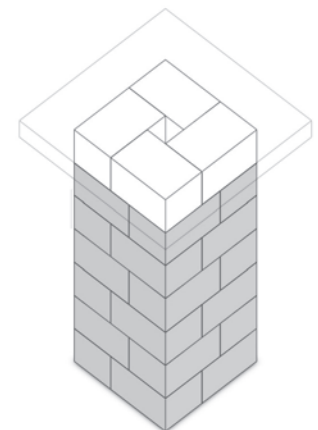

One Pillar/Corner block pallet (12 x 9 x 6" H) can build a 42" H pillar with 28 units.

Vintage 6 Wall - Basic Installation

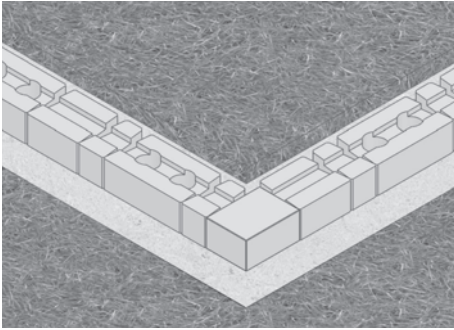

90° Outside Corner Base Course

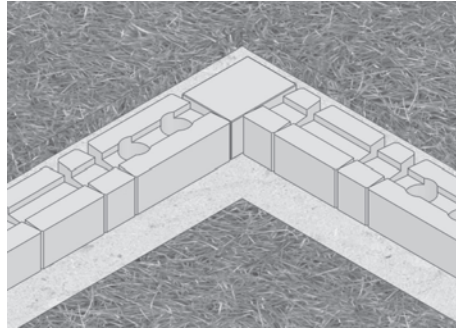

90° Inside Corner Base Course

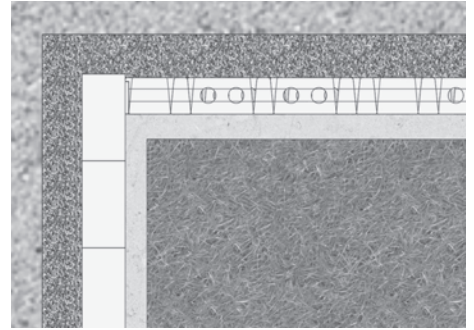

Capping a 90° inside corner

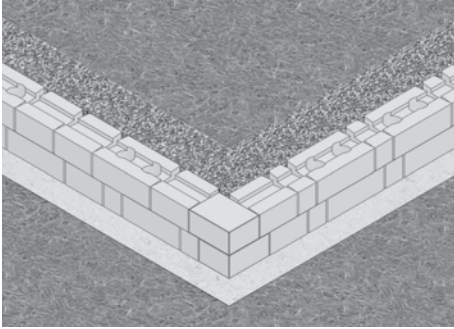

90° Outside Corner Second Course

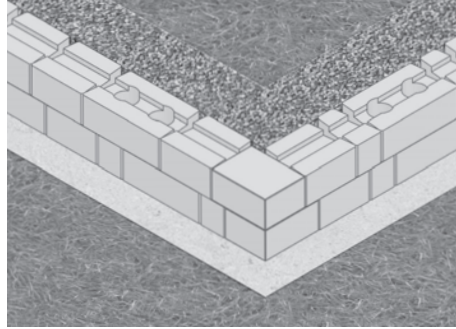

90° Inside Corner Second Course

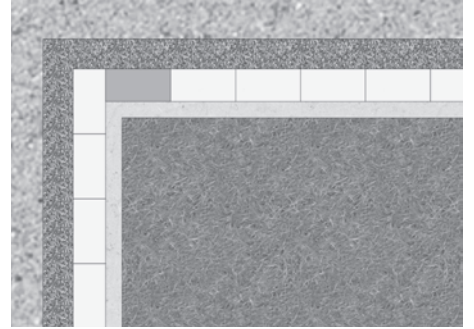

Capping a 90° inside corner

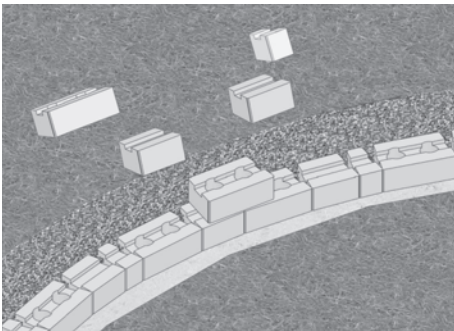

Building a Concave Curve

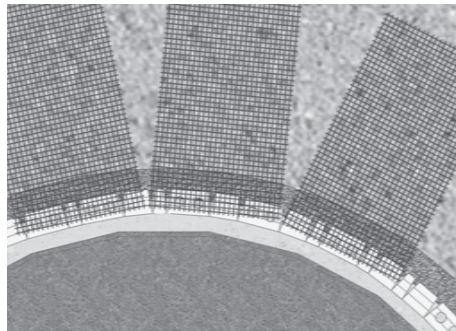

Reinforcing a Concave Curve

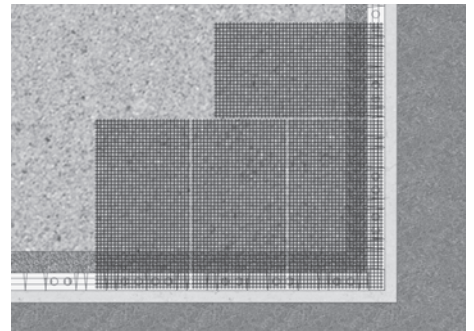

Reinforcing a 90° Outside Corner

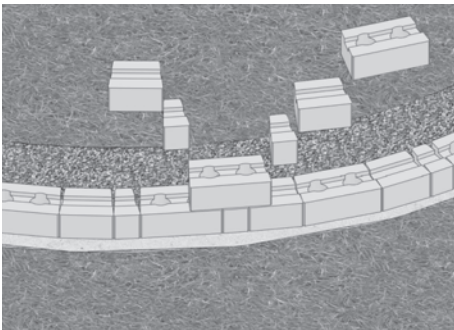

Building a Convex Curve

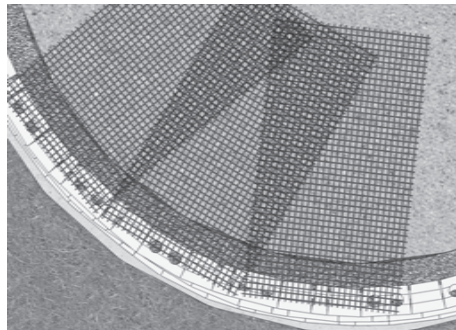

Reinforcing a Convex Curve

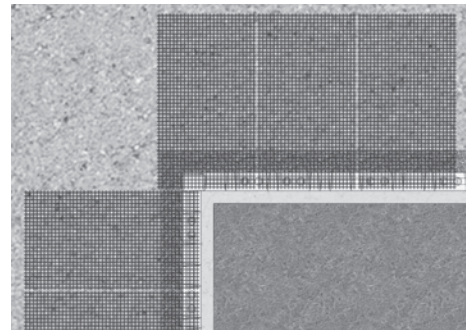

Reinforcing a 90° Inside Corner

ROCKWOOD
RETAINING WALLS
A better way.™

PLEASE NOTE: Garden walls designs above 36" and retaining walls of any height that support a load should be evaluated and approved by a qualified professional engineer.

For complete retaining wall installation instructions, request a copy of the manual for the block system you are building with. Available online at: www.rochesterpc.com/install

Sand, Sealers, Cleaners, Accessories, Adhesive



Alliance Gator

• Call for pallet weights

Item	Item Number	Package	Minimum Qty.	Pallets
G2 Supersand Beige	G2SUPERSAND001B	50 lb. bag	1	56 bags
G2 Supersand Gray	G2SUPERSAND002G	50 lb. bag	1	56 bags

Gator Dust Bond (Large joint application)

Beige	GATOR001	50 lb. bag	1	56 bags
Gray	GATOR002	50 lb. Bag	1	56 bags

Gator Maxx Bond (Overlay application) WHILE SUPPLIES LAST!

Beige	GATORMAXX01	50 lb. bag	1	56 bags
Gray	GATORMAXX02	50 lb. bag	1	56 bags

G2 Gator Maxx Bond

Beige	G2GATORMAXX01	50 lb. bag	1	56 bags
Gray	G2GATORMAXX02	50 lb. bag	1	56 bags
Ivory	G2GATORMAXX03	50 lb. bag	1	56 bags
Black Diamond	G2GATORMAXX04	50 lb. bag	1	56 bags

Binders

Rock Bond (Binder Only)	GATORROCK02	1 gal.	Box (4)	24 boxes /96 gals.
Rock Bond Kit (Binder & Rock)	GATORROCK05	1 pail	1 pail	48 pails/240 gals.
Stone Bond XP pail	SUPERB-07	1 pail	1 pail	48 pails/240 gals.
Stone Bond XP	SUPERB-09	1 gal.	Box (4)	24 boxes /96 gals.

Cleaners

Efflorescence Cleaner	GATORCLEAN03	1 gal.	Box (4)	24 boxes /96
Efflorescence Cleaner	GATORCLEAN04	5 gal. pail	1 pail	48 pails
Clean Shampoo	GATORCLEAN07	1 gal.	Box (4)	24 boxes /96
Clean Shampoo	GATORCLEAN08	5 gal. pail	1 pail	48 pails
Clean Rubber, Paint & Tar Remover	GATORCLEAN01	1 qt.	Box (6)	24 boxes /144
XP Oil & Grease Remover	GATORCLEAN0212	1 qt.	Box (6)	24 boxes /144
Clean Rust Remover	GATORCLEAN51	1 qt.	Box (6)	24 boxes /144
Gatorene Cleaner	GATORCLEAN10	1 gal.	Box (4)	24 boxes /96

Solvent Based Sealers

Seal Satin Look	GATORSEAL06	1 gal.	Box (4)	24 boxes /96
Seal Satin Look	GATORSEAL05	5 gal. pail	1 pail	48 pails
Seal Wet Look	GATORSEAL02	1 gal.	Box (4)	24 boxes /96
Seal Wet Look	GATORSEAL01	5 gal. pail	1 pail	48 pails
Seal Re Sealer	GATORRESEALER02	1 gal.	Box (4)	24 boxes /96
Seal Re Sealer	GATORRESEALER01	5 gal. pail	1 pail	48 pails
Seal Wet Cast Sealer Low Gloss + Enhancer	GATORSEAL70	1 gal.	Box (4)	24 boxes /96
Seal Wet Cast Sealer Low Gloss + Enhancer	GATORSEAL71	5 gal. pail	1 pail	48 pails

Water Based Sealers

Seal Natural Look	GATORSEAL04	1 gal.	Box (4)	24 boxes /96 gals.
Hybrid Enhancer - Low Gloss	GATORHYBRID40	1 gal.	Box (4)	24 boxes /96 gals.
Hybrid Enhancer - Low Gloss	GATORHYBRID41	5 gal. pail	1 pail	48 pails/240 gals.
Seal Natural Stone Enhancer Zero Gloss	GATORSEAL50	1 gal.	Box (4)	24 boxes /96 gals.
Seal Wet Cast Sealer Zero Gloss	GATORSEAL60	1 gal.	Box (4)	24 boxes /96 gals.
Seal Wet Cast Sealer Zero Gloss	GATORSEAL61	5 gal. pail	1 pail	48 pails/240 gals.

Accessories

Nails Common 10 (180/box)	NAIL COM 10	50 lbs. box	1 box	48 boxes
Nails Common 12 (180/box)	NAIL COM 12	50 lbs. box	1 box	48 boxes
Nails Spiral 10 (180/box)	NAIL SPIR 10	50 lbs. box	1 box	48 boxes
Nails Spiral 12 (180/box)	NAIL SPIR 12	50 lbs. box	1 box	48 boxes
Aqua Rock Granite Gray for Permeable Pavers	GATORAQUA01	50 lbs. bag	1 bag	56 bags
Gator Base	GATORBASE01	10/pkg	1 pkg	12 packages
Gator Screws	GATORSCREW001	50/pkg	1 pkg	40 cases (20 pkg's ea.)

Adhesives

Rockwood Super-Stik (12 tubes/case)	1140001	10.3 oz.	1 case	108/pallet
Rockwood Super-Stik (12 tubes/case)	1140002	28 oz.	1 case	44/pallet
Block Bond XP Polyurethane Low VOC-Black (12 Tubes)	GBBXP 10.3	10.3 oz.	1 case	90/pallet
Block Bond XP Polyurethane Low VOC-Black (12 Tubes)	GBBXP28	28 oz.	1 case	60/pallet
Block Bond HP Low VOC (White)	GDBHP01	10.3 oz.	1 case	90/pallet
Block Bond HP Low VOC (White)	GDBHP03	28 oz.	1 case	60/pallet

EDGING

Gator Edge Rigid	GATOREEDGE001	8" length	24 pcs./bundle	672/pallet
Gator Edge Flex	GATORFLEX001	8" length	24 pcs./bundle	672/pallet
Gator Edge Mini-Pro	GATOREEDGE003	8" length	24 pcs./bundle	384/pallet

General Terms and Conditions of Sale

These General Terms and Conditions of Sale (these "Terms and Conditions") will apply to the sale of goods and any (if any) applicable services (collectively, with any such services, being the "Goods") pursuant to any contract (a "Contract") to which these Terms and Conditions are made applicable. As used in these Terms and Conditions, "we," "us," "our" and similar terms refer to Rochester Concrete Products, LLC, and "Customer" means the party purchasing the Goods from us.

Alteration. No provision in these Terms and Conditions may be varied or waived except by a writing signed by us specifically referring to these Terms and Conditions and describing such variance or waiver. Our acceptance or acknowledgment of Customer's purchase order or any other document pertaining to the Goods, even if in writing and signed by us, will not be deemed an acceptance of any provision of Customer's purchase order or any other document that conflicts with or adds to these Terms and Conditions, absent a separate agreement in writing signed by us expressly acknowledging and agreeing to such provisions. Without limiting the generality of the foregoing, we object to any different or additional terms or conditions contained in any request for quotation, purchase order or other document of Customer, and no such terms will be effective or binding upon us unless we agree to such terms in a writing signed by one of our officers. In no event will our delivery of any Goods be an assent to any such terms proposed by Customer. Unless otherwise expressly stated in any applicable quotation or comparable document signed by us, we may revoke any quotation or other offer at any time prior to acceptance, and no such quotation or other offer will be valid for more than 30 days. After acceptance of an order, Customer may not cancel or terminate any Contract without our consent, except as provided herein or by applicable law.

Payment; Delivery. All prices are quoted and all payments will be made in U.S. Dollars. Customer will pay our invoices IN FULL on the terms stated in the applicable invoice, without set-off or counterclaim. Past due invoices will bear a late fee of 1.0% per month or, if less, the highest rate permitted by applicable law. Any stated shipment or delivery date is the date on which we in good faith believe the Goods will be shipped, but failure to ship on that date will not be a breach of the Contract, whether such Goods are in fact shipped before or after that date. All Goods are shipped Ex Works (Incoterms 2010) at our facilities, and costs of transportation and risk of loss during shipment will be borne by Customer. We may deliver any Goods hereunder in installments, in which case each installment will be treated as a separate sale hereunder and may be separately invoiced. Customer will pay all duties and sales, value-added, excise, use or other taxes arising in connection with any transaction (other than taxes based solely on our taxable income). Unless otherwise specified, Goods will be shipped in packaging we reasonably select.

Duty to Inspect. Customer will inspect all Goods promptly upon delivery and notify us promptly upon becoming aware of any non-conformity to the Contract. Except as stated regarding any applicable written warranty, we will have no liability regarding any such non-conformity unless such notice is given to us no later than (i) for a defect that could be determined by inspection upon delivery, the 30th day after delivery of such Goods, or (ii) for any other defect, the 30th day after such defect should reasonably have been discovered by Customer, but in each event not later than the 60th day after delivery of the Goods to Customer. Shipments less than 5% over or under the quantity specified in the Contract will be deemed in conformance with the Contract. Goods will not be deemed

non-conforming solely by reason of minor modifications or changes in materials from those specified in the Contract, so long as such modifications and changes do not materially and adversely affect the performance of the Goods. If the Goods do not conform to the Contract, our obligation will be limited to, at our election, supplying the missing Goods, replacing the relevant Goods, or refunding the purchase price paid for such Goods (but in all cases as otherwise may be limited in any other Paragraph of these Terms and Conditions or the Contract).

Security Interest. We reserve, and Customer hereby grants to us, a security interest in all Goods. That security interest secures all present and future obligations of Customer to us, including but not limited to the obligation to pay the price of the Goods. We may make any such filings as reasonably necessary to perfect such security interest (and Customer will cooperate promptly in all reasonable respects in connection therewith).

Our Warranty. Customer will ensure that any written warranty that we provide with the Goods is properly given to the end user of the Goods (whether by providing such warranty directly or causing Customer's contractors to do so).

Limited Warranty. We make no warranty of any nature whatsoever with respect to the Goods, other than any written, limited warranty that we may provide at the time we provide the Goods. If Customer discovers any breach of or similar creation of obligation under the warranty described above, Customer must notify us in writing thereof within 30 days after such discovery. Within a reasonable time following such notification, we will determine whether such warranty in fact applies and will, at our option, either (i) repair or replace the applicable Goods, (ii) remit to Customer the purchase price paid for such Goods, or (iii) take any other action consistent with the terms of such warranty. THE FOREGOING WARRANTIES ARE EXCLUSIVE. WE MAKE NO OTHER WARRANTY, EXPRESS OR IMPLIED, INCLUDING BUT NOT LIMITED TO ANY IMPLIED WARRANTY OF MERCHANTABILITY, NON-INFRINGEMENT OR FITNESS FOR A PARTICULAR PURPOSE. THE REMEDIES SET FORTH IN THIS PARAGRAPH ARE THE EXCLUSIVE REMEDY FOR ANY BREACH OF OR SIMILAR CREATION OF OBLIGATION UNDER WARRANTY. The remedies set forth in this Paragraph will not be deemed to have failed of their essential purpose so long as we are willing and able to provide one of the applicable remedies set forth herein.

Limitations. WITHOUT LIMITING ANY OTHER LIMITATION OF LIABILITY, IN NO EVENT WILL WE BE LIABLE FOR ANY INCIDENTAL, INDIRECT OR CONSEQUENTIAL DAMAGES OF ANY KIND, WHETHER FOR BREACH OF ANY WARRANTY, BREACH OR REPUDIATION OF ANY OTHER TERM OR CONDITION, NEGLIGENCE, STRICT LIABILITY, OR OTHERWISE. IN NO EVENT WILL OUR AGGREGATE LIABILITY TO, THROUGH OR ON BEHALF OF CUSTOMER IN ANY WAY RELATED TO THIS OR ANY RELATED TRANSACTION EXCEED THE TOTAL AMOUNT PAID TO US UNDER THE APPLICABLE CONTRACT.

Force Majeure. We will not be liable for any failure to manufacture, deliver or provide, or for any delay in the manufacture, delivery or provision of, any Goods if such failure or delay is caused by act of God, fire, strike, blackout, labor difficulty, riot, inability to obtain raw materials, supplies or other goods or services, equipment, labor or transportation, governmental restrictions, public health nuisance, or similar cause over

which we are unable to exercise adequate control. We may cancel any Contract by notice to Customer if we determine in good faith that any such cause makes performance of the Contract impossible or commercially impracticable for us.

Confidential Information. "Confidential Information" means information that you obtain from or regarding us regarding our products, business practices, customers, assets or other matters, excluding any information that is publicly available when provided or thereafter becomes publicly available, other than by reason of your breach hereof. You will (i) not use any Confidential Information other than for the performance of any Contract, (ii) not disclose Confidential Information, except to your employees and contractors requiring such information for the performance of any Contract, (iii) use your best efforts to prevent your employees, your contractors, and your contractors' employees from using or disclosing Confidential Information to any party, except as permitted by this Paragraph, and (iv) return all Confidential Information to us upon our request following completion or termination of any Contract. This Paragraph (and all related rights and remedies) will survive performance or termination of any Contract.

Miscellaneous. All rights and obligations under these Terms and Conditions and any Contract will be governed by the laws of the State of Minnesota (without regard to principles of conflicts of law). The headings herein are for convenience of reference only and will not affect any meaning or interpretation. The United Nations Convention on Contracts for the International Sale of Goods will not apply. CUSTOMER HEREBY IRREVOCABLY SUBMITS TO THE EXCLUSIVE JURISDICTION OF ANY COURT SITTING IN HENNEPIN COUNTY, MINNESOTA, IN ANY PROCEEDING ARISING OUT OF OR RELATING TO THE INTERACTIONS BETWEEN US AND CUSTOMER AND TO THE RESPECTIVE COURT TO WHICH AN APPEAL OF THE DECISIONS OF ANY SUCH COURT MAY BE TAKEN, AND CUSTOMER AGREES NOT TO COMMENCE, OR COOPERATE IN OR ENCOURAGE THE COMMENCEMENT OF, ANY SUCH PROCEEDING, EXCEPT IN SUCH A COURT. CUSTOMER HEREBY IRREVOCABLY WAIVES, TO THE FULLEST EXTENT IT MAY DO SO, THE DEFENSE OF AN INCONVENIENT FORUM TO THE MAINTENANCE THEREIN OF SUCH A PROCEEDING. CUSTOMER HEREBY AGREES THAT A FINAL JUDGMENT IN ANY SUCH PROCEEDING WILL BE CONCLUSIVE AND MAY BE ENFORCED IN ANY JURISDICTION BY SUIT ON THE JUDGMENT OR BY ANY OTHER MANNER PROVIDED BY APPLICABLE LAW. CUSTOMER HEREBY EXPRESSLY WAIVES ANY RIGHT IT MAY HAVE TO A JURY TRIAL IN ANY SUCH PROCEEDING. NO CLAIM OR ACTION, REGARDLESS OF FORM, ARISING OUT OF THE INTERACTIONS BETWEEN US AND CUSTOMER MAY BE BROUGHT BY OR ON BEHALF OF CUSTOMER MORE THAN ONE YEAR AFTER THE CAUSE OF ACTION HAS ACCRUED (SUBJECT TO ANY FURTHER APPLICABLE LIMITATION). IF ANY SUCH LEGAL ACTION IS BROUGHT, THE PREVAILING PARTY WILL BE AWARDED REASONABLE ATTORNEYS' FEES IN ADDITION TO ANY OTHER RELIEF THAT MAY BE GRANTED.
Version 3/20/13

RCP, LLC Limited Lifetime Warranty

Congratulations on choosing Rochester Concrete Products, LLC ("RCP") products to protect and beautify your home. These superior-quality hardscape products have been designed to give you years of enjoyment and comfort.

IMPORTANT NOTICE: Read this entire RCP Limited Lifetime Warranty and Limitation of Liability ("Limited Warranty"). It is important that the warranted products be properly installed and maintained in order for them to function successfully throughout the duration of this Limited Warranty. Depending on the product's application, installation guides can be found at www.rochesterpc.com. It is also important for your installer to carefully review the technical information, including specifications, for the chosen use of your RCP products as it may be the responsibility of the installer or design engineer to provide independent soil testing, quality assurance inspection, testing, and design services necessary to insure a safe and functional application.

This Limited Warranty applies only to RCP products that are purchased and used as part of Rockwood Retaining Wall Systems installed in owner-occupied single-family homes within the United States, subject to the stated conditions and limitations. This Limited Warranty does not extend to any current or future products distributed, but not manufactured, by RCP. This Limited Warranty applies only to RCP's products and not to the system into which they may be placed. Nor does this Limited Warranty cover to RCP products used in governmental, commercial, or multi-residential applications.

LIMITED LIFETIME WARRANTY FOR RCP PRODUCTS INSTALLED IN OWNER-OCCUPIED SINGLE-FAMILY HOMES AS A PART OF A ROCKWOOD WALL OR HARDSCAPE SYSTEM. RCP warrants that its products will be free from defects for as long as you own your home. If RCP is given prompt notice of a defect, it shall, at its sole option: (1) repair or replace the defective product(s), or (2) refund the original purchase price of the defective product(s). This Limited Lifetime Warranty is provided only to the owner(s) of the home at the time of purchase and may not be assigned or transferred. In the event the owner(s) sells the home, this warranty automatically converts to a two-year limited warranty affording the same scope of protection and governed by the same conditions, disclaimers and limitations of this Limited Lifetime Warranty. If RCP elects to repair the defect, it shall be responsible for the labor to accomplish the repair. If RCP elects to replace the defective product(s), its obligation is to deliver suitable replacement product to owner's property.

LIMITATION OF LIABILITY

This Limited Warranty sets forth the maximum liability for our products. **IN NO EVENT (INCLUDING WHERE THIS LIMITED WARRANTY IS DEEMED NOT TO APPLY TO THE SALE OR PRODUCT IN QUESTION) SHALL RCP, GLS INDUSTRIES, INC., OR ROCKWOOD RETAINING WALLS, INC. BE LIABLE FOR ANY INCIDENTAL, CONSEQUENTIAL OR SPECIAL DAMAGES RESULTING FROM THE SALE, INSTALLATION OR USE OF ANY RCP PRODUCTS.** Some states do not allow the exclusion or limitation of incidental or consequential damages for consumers, so the above limitation or exclusion may not apply to you.

LIMITATION OF WARRANTY

RCP MAKES NO OTHER WARRANTIES, EXPRESS OR IMPLIED, INCLUDING ANY IMPLIED WARRANTIES FOR MERCHANTABILITY, FITNESS FOR A PARTICULAR PURPOSE OR OTHERWISE.

DISCLAIMER – WHAT THIS LIMITED WARRANTY DOES NOT COVER

RCP is not responsible for or makes no warranty as to:

1. Product failure, loss or damage due to:
 - Normal wear and tear;
 - Damage due to improper handling and repeated or extended contact with chemicals, such as deicers;
 - Products improperly installed or maintained;
 - Acts of God;
 - Structural settlement, movement or vibration;
 - Products that have not been paid for in full.
2. Minor imperfections
 - Minor imperfections that do not affect the product's structural integrity;
 - Variations in product texture or color;
 - Efflorescence;
 - Minor imperfections in shape, appearance, or dimensions covered by ASTM C1372.

CONDITIONS OF WARRANTY – WHAT YOU MUST DO TO RECOVER UNDER THIS LIMITED WARRANTY

Prompt Notice of Defect:

Within the warranty period, you must promptly, and in no case more than one (1) year after any defect or other basis of a claim covered by this Limited Warranty is discovered or should have been discovered, notify RCP of the defect. Any claims otherwise covered by this Limited Warranty, but for which RCP did not receive notice of the defect within one (1) year from the time the problem first became known shall be barred.

LIMITED WARRANTY CLAIM PROCEDURE

Claims under this Limited Warranty may be made in writing to RCP at 7200 Broadway Ave. N., Rochester, MN, 55906. Claims should include the following information:

1. Claimant's name, address, and phone number and the installation address (if different);
2. A description of the product, purchase price, date and location of purchase, and copies of invoices, if available;
3. A description of the defect(s) (photos are required); and
4. A brief summary of attempts made to address the concerns.

NO STATEMENT OF USEFUL LIFE

This Limited Warranty is not a statement of the useful life of any RCP products.

z.us.51883281.01



welcome to the backyard...



**Rochester Concrete Products
Corporate Office**

7200 Broadway Ave. N.
Rochester, MN 55906
(507) 288-8850
(507) 288-3810 (fax)

www.rochestercp.com

© Copyright 2020, Rochester Concrete Products. All Rights Reserved. All trademarks and registered trademarks are the property of their respective owners. Rockwood Retaining Walls products are made worldwide under license from Rockwood Retaining Walls, Inc. US and international patents issued and pending. The information presented here has been prepared for the benefit of customers interested in Rochester Concrete Products, it was reviewed carefully prior to publication. Rochester Concrete Products assumes no liability for its accuracy or completeness. Final determination of the suitability of any information or material for the use contemplated, or for its manner of use, is the sole responsibility of the user. PROPOSITION 65 WARNING: These Products, the fuel used in this Products and other wood and charcoal burning appliances, and the combustion products of such fuels contain chemicals known to the State of California to cause cancer, or birth defects or other reproductive harm. 120

