

# ROSETTA®

## TECHNICAL GUIDE



STEPS • PAVERS • RETAINING WALLS • FIRE PITS • FIREPLACES



It's been a few days on site as you lay the last block of the job and sweep off the top. You and your crew have worked hard, and your customer has become your friend. It's hard to beat the feeling of a job well done, and you know that feeling better than anyone.

But too often, getting to the end of a project involves headaches and hiccups. What if you and your team could always quickly and easily install uniquely beautiful, quality hardscapes? Now you can.

With Rosetta Hardscapes, you can offer your customer an attractive alternative to both natural stone and typical, manufactured retaining wall and paver products. The hardscapes described in this technical guide are simply installed, but look just like natural stone. Your customer will love their finished landscape, and you'll be able to get to that point of satisfaction even faster than normal.





With this guide you can wow the homeowners you work for without any added hassle. Whether your plan calls for retaining walls, pavers or steps, we're here to help you create the most beautiful landscape possible. These pages explain the best way to get to your next stunning and satisfying, "job well done."







Visit [RosettaHardscapes.com/TechResources](https://RosettaHardscapes.com/TechResources) for more tools to help you love your work.





## TABLE OF CONTENTS

<b>RETAINING WALL COLLECTION</b>	
Outcropping .....	4-5
Belvedere .....	6-7
Kodah .....	8
Dimensional Wall .....	9
Claremont .....	10
<b>PAVING/SLAB COLLECTION</b>	
Grand Flagstone .....	11
Dimensional Flagstone .....	12
24x24 Flagstone .....	13
Linear Flagstone.....	13
Mission Paver Collection .....	14
Amaro Paver .....	15
Miros.....	16
Superior Steppers.....	17
<b>STEP COLLECTION</b>	
Dimensional Steps .....	18
Irregular Steps .....	19
6' Irregular Steps.....	19
<b>ADDITIONAL COLLECTIONS</b>	
Coping and Caps .....	20
Fireplace Kits .....	21
Fire Pit Kits .....	22-23
<b>RETAINING WALL INSTALLATION GUIDE</b>	
General Installation Instructions .....	24-27
Outcropping .....	28-31
Belvedere .....	32-35
Kodah .....	36
<b>PAVER INSTALLATION GUIDE</b>	
General Installation Instructions .....	37
Grand Flagstone .....	38-39
Dimensional Flagstone .....	40
Mission Paver Collection .....	41
<b>STEP INSTALLATION GUIDE</b>	
Installation Instructions .....	42

OUTCROPPING RETAINING WALL PALLETS

Stone & Bundling	Unit Dimensions L" x H"	Units/Bundle	Weight/Stone lbs
	42" x 12"	1	750 ±
	48" x 12"	1	900 ±
	60" x 12"	1	1100 ±
	66" x 12"	1	1150 ±

	24" x 6"	1	250 ±
	36" x 6"	1	320 ±
	48" x 6"	1	450 ±
	36" x 12"	1	620 ±
	54" x 12"	1	950 ±
	72" x 12"	1	1300 ±

	24" x 6"	1	250 ±
	36" x 6"	1	320 ±
	60" x 18"	1	1600 ±
	48" x 24"	1	1800 ±

Galvanized Steel hooks are available and required for reinforced walls.  
Actual weight and color may vary.



**OUTCROPPING PALLET A**

- Pallet weight = ± 4000 lbs
- Coverage = 18 sqft



**OUTCROPPING PALLET B**

- Pallet weight = ± 4000 lbs
- Coverage = 18 sqft





**OUTCROPPING PALLET C**

- Pallet weight = ± 4000 lbs
- Coverage = 18 sqft

OUTCROPPING CORNER PALLETS

Rosetta has two corner blocks to help make a 90° corner in the wall. The corner blocks are four-sided, and can be installed with alternating faces exposed to maintain a more random look.

The size of the corner blocks have been chosen to account for the wall batter in both directions. Two 6" high corner blocks are typically stacked on top of each other and placed on top of a 12" block. The corner blocks are intended to be stepped back 3" in both directions. In a few areas, you may need to trim a small part of the corner blocks near the back of the wall to avoid interference with the shear heels on adjacent blocks.

Stone & Bundling	Unit Dimensions L" x W" x H"	Units/Bundle	Weight/Stone lbs
 Corner	39" x 27" x 6"	4	480 ±
 Corner	48" x 30" x 12"	3	1170 ±



**CORNER PALLET 6"**



- Pallet weight = ± 2015 lbs
- Coverage = 11 sqft



**CORNER PALLET 12"**

- Pallet weight = ± 3600 lbs
- Coverage = 19.5 sqft



OUTCROPPING FREESTANDING WALL PALLETS

Stone & Bundling	Unit Dimensions L" x W" x H"	Units/Bundle	Weight/Stone lbs
 Pallet D	60" x 30" x 12"	1	1540 ±
 Pallet D	48" x 30" x 12"	1	1080 ±
 Pallet D	48" x 30" x 6"	1	460 ±



**OUTCROPPING PALLET D**

- Pallet weight solid = ± 3150 lbs
- Coverage = 11 sqft

 Pallet E	72" x 30" x 12"	1	2080 ±
 Pallet E	36" x 30" x 12"	1	880 ±
 Pallet E	36" x 30" x 6"	1	440 ±









**OUTCROPPING PALLET E**

- Pallet weight solid = ± 3450 lbs
- Coverage = 10.5 sqft

For more information visit  
[rosettahardscapes.com/technical-resources-outcropping-by-rosetta](http://rosettahardscapes.com/technical-resources-outcropping-by-rosetta)

## BELVEDERE WALL PALLETS

Belvedere Collection wall blocks are provided in six basic sizes. The wall blocks are finished on both the front and back faces of the wall blocks and they are tapered on each side approximately 1" from the front to the back of the block. There are multiple face textures for each basic block size to provide a more random look for your finished project. Average block weights of the different face textures patterns are shown. Weights of individual blocks may vary.

Stone & Bundling	Unit Dimensions L" x W" x H"	Units Bundle	Weight/ Stone lbs
 Block 1	6" x 9" x 3"	12	10 ±
 Block 2	12" x 9" x 3"	12	20 ±
 Block 3	18" x 9" x 3"	12	36 ±
 Block 4	6" x 9" x 6"	12	21 ±
 Block 5	12" x 9" x 6"	12	42 ±
 Block 6	18" x 9" x 6"	12	67 ±





### WALL PALLET

- Pallet weight = ± 2,475 lbs (incl. pallet weight)
- Coverage = 27 sqft / Pallet when used in a Retaining Wall and 25 sqft / Pallet when used in a Freestanding wall
- Section = 9 sqft per 2 layers (1 Layer of 6" and 1 Layer of 3")

## BELVEDERE CORNER PALLETS

The Belvedere Collection contains 2 corner blocks. These blocks are finished on 3 sides, and the 4th side is tapered to fit with the other retaining wall blocks. The corner blocks can be used to construct columns, provide a finished end on a freestanding wall, and make 90° corners. There are multiple face textures for the faces of both column blocks sizes, thus providing a more random look for your finished project. Average block weights of the different face textures. Weight of individual blocks may vary.

Stone & Bundling	Unit Dimensions L" x W" x H"	Units Bundle	Weight/ Stone lbs
 Block 7	15" x 9" x 3"	16	30 ±
 Block 8	15" x 9" x 6"	16	58 ±







### CORNER PALLET

- Pallet weight = ± 1,520 lbs (incl. pallet weight)
- Coverage = 24 sqft / Pallet
- Section = 1.5 sqft (one 6" piece and one 3" piece)

## BELVEDERE COPING PALLETS

Coping blocks are provided in five basic sizes. There are three standard coping blocks which are finished on the front, back, and top faces. The standard coping blocks are tapered approximately 1" on each side from the front to the back of the block. There are also two end units which are finished on front, back, top, and one of the sides. The other side is tapered approximately 1" from the front to the back of the block. The end units are useful for constructing corners and ends. There are multiple face textures for each basic block size, providing a more random look for your finished project.

Dimensional Coping is also an option for capping the Belvedere Wall (Dimensional coping can be seen on page 20). Average block weights of the different face textures are shown. Weights of individual blocks may vary.

Stone & Bundling	Unit Dimensions L" x W" x H"	Units Bundle	Weight/ Stone lbs
 Block 9	6" x 10 <sup>1/4</sup> " x 2 <sup>1/4</sup> "	24	10 ±
 Block 10	12" x 10 <sup>1/4</sup> " x 2 <sup>1/4</sup> "	24	20 ±
 Block 11	18" x 10 <sup>1/4</sup> " x 2 <sup>1/4</sup> "	12	30 ±
 Block 12	18" x 10 <sup>1/4</sup> " x 2 <sup>1/4</sup> " (Left End)	6	30 ±
 Block 13	18" x 10 <sup>1/4</sup> " x 2 <sup>1/4</sup> " (Right End)	6	30 ±



### COPING PALLET

- Pallet weight = ± 1,550 lbs (incl. pallet weight)
- Coverage = 66 linear feet / Pallet
- Section = 11 LF per 1 Layer





## 27-INCH COLUMN CAP PALLETS

Stone & Bundling	Unit Dimensions L" x W" x H"	Units Bundle	Weight/ Stone lbs
 27-Inch Column Cap	27" x 27" x 2 <sup>1/2</sup> "	10	150 ±

For more information visit  
[rosettahardscapes.com/technical-resources-belvedere-walls-by-rosetta](http://rosettahardscapes.com/technical-resources-belvedere-walls-by-rosetta)

## KODAH FREESTANDING WALL PALLETS

Kodah Freestanding Wall Blocks are provided in four basic sizes. The blocks are finished on both the front and back faces of the wall blocks and they are tapered on each side approximately 1/2" from the front to the back of the block. There are multiple face textures for each basic block size to provide a more random look for your finished project. Average block weights of the different texture patterns are shown. Weights of individual blocks may vary. Dimensions are nominal due to texture.

Stone & Bundling	Unit Dimensions L" x W" x H" <i>*Nominal due to texture</i>	Units Bundle	Weight/ Stone lbs
 Block 1	42" x 10 1/2" x 6" ±	6	200 ±
 Block 2	30" x 10 1/2" x 6" ±	3	140 ±
 Block 3	21" x 10 1/2" x 6" ±	6	100 ±
 Block 4	12" x 10 1/2" x 6" ±	3	50 ±



### KODAH FREESTANDING WALL PALLET

- Pallet weight = ±2,500 lbs (incl. pallet weight)
- Coverage = 21 sqft/pallet when used in a retaining wall and 20 sqft when used in a freestanding wall.
- Section = 7 sqft per layer

## KODAH FREESTANDING CORNER PALLETS

The Kodah Collection contains two corner blocks. These blocks are finished on three sides, and the fourth side is tapered to fit with the other retaining wall and freestanding wall blocks. The corner blocks can be used to construct columns, provide a finished end on a freestanding wall, and make 90° corners. There are multiple face textures for the faces of both corner blocks, thus providing a more random look for your finished project. Average block weights of the different face textures are shown. Weights of individual blocks may vary. Dimensions are nominal due to texture.



Stone & Bundling	Unit Dimensions L" x W" x H" <i>*Nominal due to texture</i>	Units Bundle	Weight/ Stone lbs
 Block 1	21" x 10 1/2" x 6" ±	24	100 ±



### KODAH CORNER PALLET

- Pallet weight = ±2,500 lbs (incl. pallet weight)
- Coverage = 31.5 sqft/pallet
- Section = 1.3 sqft per piece

## DIMENSIONAL WALL PALLETS

Stone & Bundling	Unit Dimensions L" x W" x H"	Units Bundle	Weight/ Stone lbs
 Straight	12" x 8" x 4"	75	28 ±
 Wedge	(Front) 12" x 8" x 4" (Back) 7.5" x 8" x 4"	100	20 ±



### DIMENSIONAL STRAIGHT PALLET

- Pallet weight = ± 2,100 lbs (incl. pallet weight)
- Coverage = 25 sqft/Pallet (Retaining)  
25 sqft/Pallet (Freestanding)
- Section = Sold by the piece



### DIMENSIONAL WEDGE PALLET

- Pallet weight = ± 2,000 lbs (incl. pallet weight)
- Coverage = 33.3 sqft/Pallet (Retaining)  
27 sqft/Pallet (Freestanding)
- Section = Sold by the piece

*Actual weight and volumes may vary. Weight shown is based on concrete.*

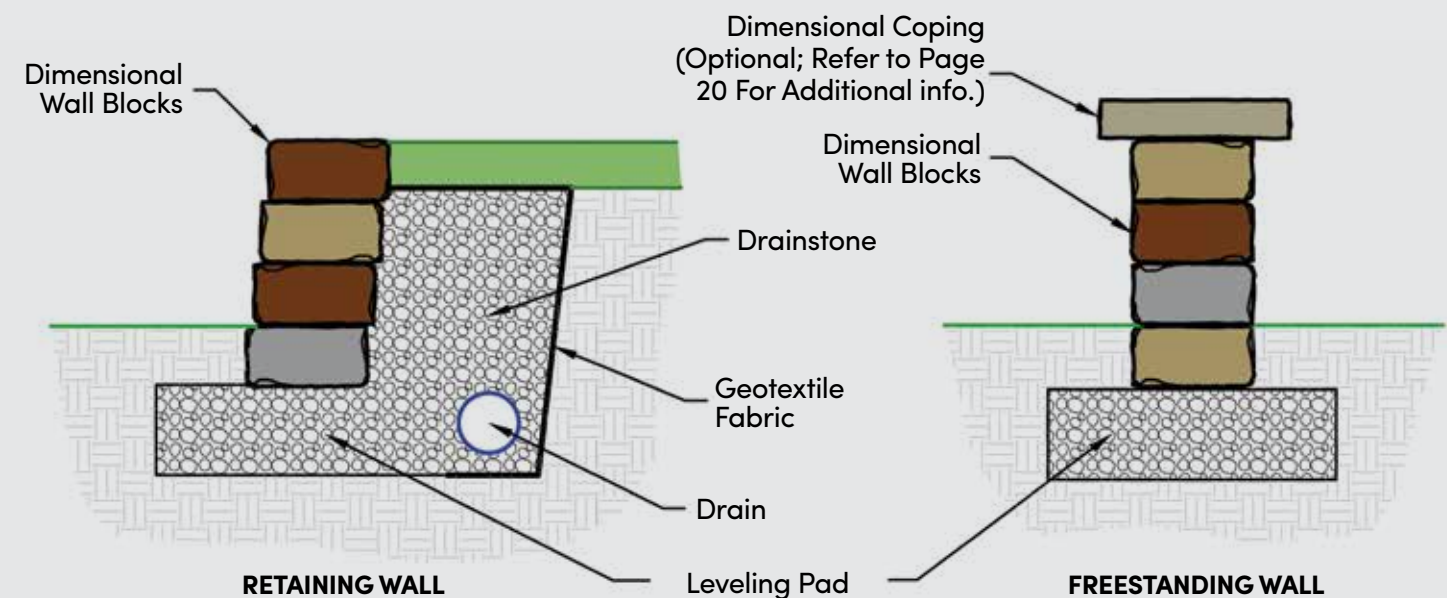

## RETAINING / FREESTANDING WALL



*Actual weight may vary. Packaging may vary by location. Check with local supplier for details.*

For more information visit  
[rosettahardscapes.com/technical-resources-kodah-by-rosetta](http://rosettahardscapes.com/technical-resources-kodah-by-rosetta)

CLAREMONT WALL PALLETS

Stone & Bundling	Unit Dimensions L" x W" x H"	Units Bundle	Weight/Stone lbs
 18"	18" x 8" x 4"	25	43 ±
 24"	24" x 8" x 4"	25	61 ±
 Corner	22" x 8" x 4"	40	53 ±



**CLAREMONT WALL PALLET**

- Pallet weight = ± 2,800 lbs (incl. pallet weight)
- Pieces on Pallet = 25 pieces of 18", 25 pieces of 24"
- Coverage = 29 sqft/Pallet
- Section = 1.16 sqft = 1ea 18" and 1ea 24"



**CLAREMONT CORNER PALLET**

- Pallet weight = ± 2,200 lbs (incl. pallet weight)
- Pieces on Pallet = 40 pieces
- Coverage = 33.3 sqft/Pallet
- Section = .83 sqft = 1 piece (section sold by the piece)

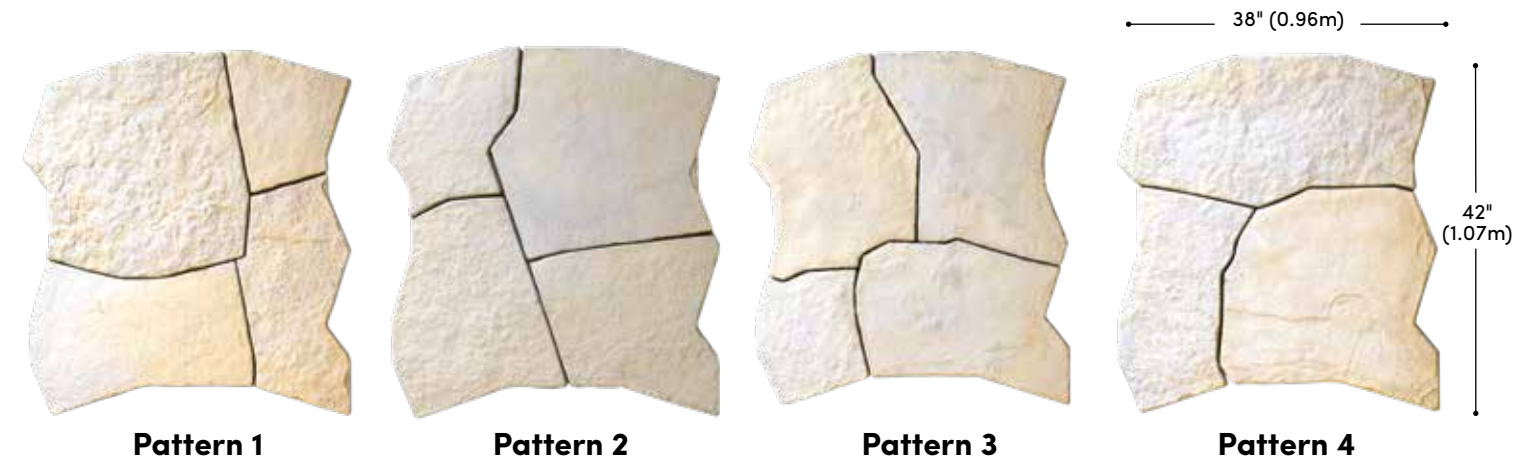

Outside dimensions of each pattern are identical to all other patterns, allowing any pattern to be used anywhere in the layout. Random assortment of patterns provided on each pallet. Exact proportion of patterns and pattern designs may vary.

\*Each pattern contains three or four individual pieces

**GRAND FLAGSTONE PALLET**

- 8 Layers per pallet (random assortment)
- Pallet weight = ± 2,000 lbs (incl. pallet weight)
- Coverage = 90 sqft/Pallet
- Section = 11.25 sqft per 1 layer



PILLAR CONSTRUCTION DETAILS

This page shows typical construction details for Claremont pillars. Pillars make nice ends to Freestanding walls, formal stair openings, stand-alone monuments, and other areas to enhance your Claremont project. The basic steps of pillar construction are shown here. Feel free to expand on these ideas and bring your own imagination into creating a custom project.



**Step 1**  
Place (4) Claremont corner blocks with the texture facing outward.



**Step 2**  
Place the second row of (4) of the corner blocks with the texture facing outward.



**Step 3**  
Continue with subsequent rows to the desired pillar height. One pallet of corner blocks will make a 30" x 30" x 40" high column.

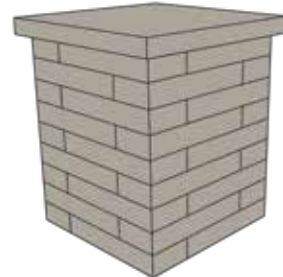

**Step 4**  
Place a column cap to finish the pillar. The column cap can be cored as needed for installation of a lamp.

**OUTSIDE CURVE**

The minimum radius without cutting is 14'. Wall aesthetics can be improved by using a radius larger than the minimum required.

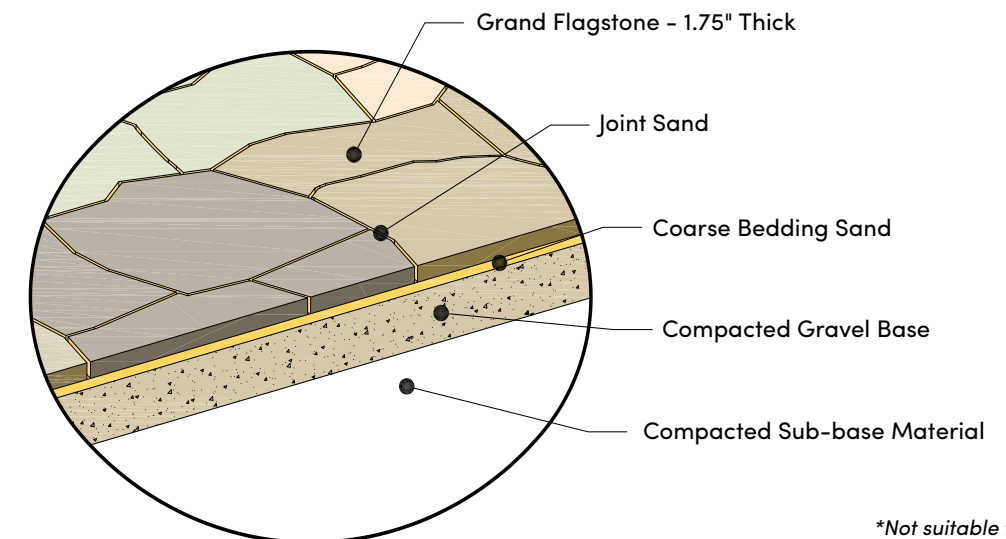
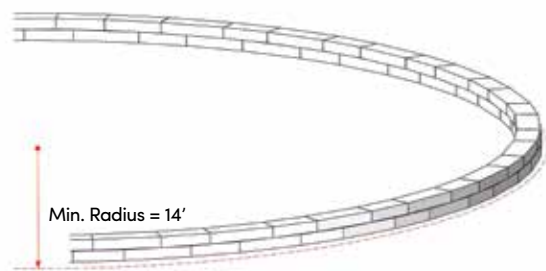

\*Not suitable for vehicular applications

For more information visit  
[rosettahardscapes.com/technical-resources-claremont-by-rosetta](http://rosettahardscapes.com/technical-resources-claremont-by-rosetta)

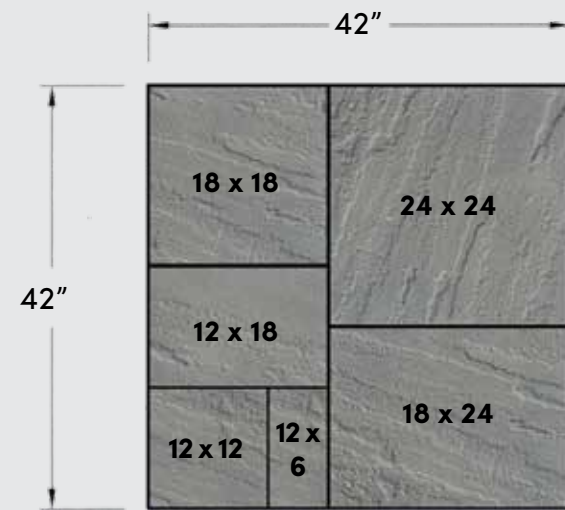
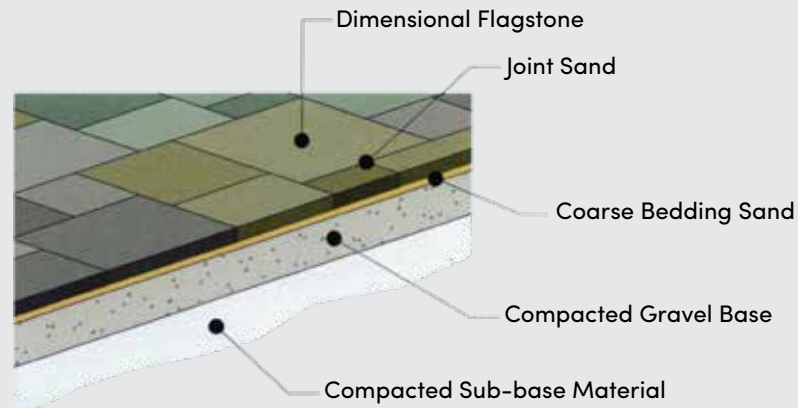

**DIMENSIONAL FLAGSTONE PALLET**

- All sizes on every pallet
- Consistent 2" thickness
- One layer = one pattern
- 8 layers per pallet
- Pallet weight = ± 2,350 lbs (incl. pallet weight)
- Coverage = 98 sqft/Pallet
- Section = 12.25 sqft per layer

*\*Not suitable for vehicular applications*



24x24 FLAGSTONE



- Same size 24"x24" pieces
- Consistent 2" thickness
- Pallet weight ± 1600 lbs (incl. pallet weight)
- Coverage = 64 sqft/pallet
- Units per bundle = 16
- Weight per stone = 96 lbs

*\*Not suitable for vehicular applications*

**24x24 FLAGSTONE CROSS-SECTION (on-grade installation)**

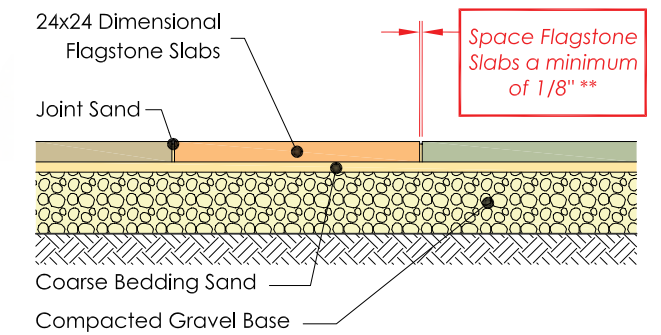

**\*\* 24x24 Flagstone slabs must be spaced apart a minimum of 1/8".** These slabs were originally developed for use with roof-top pedestal mount systems. On-grade installations require manually spacing the slabs apart. This can be achieved using a pair of 1/8" wooden shims or by using removable tile spacers. Failure to provide a relief joint will restrict the seasonal flexibility of the patio.

**DIMENSIONAL FLAGSTONE CROSS-SECTION**

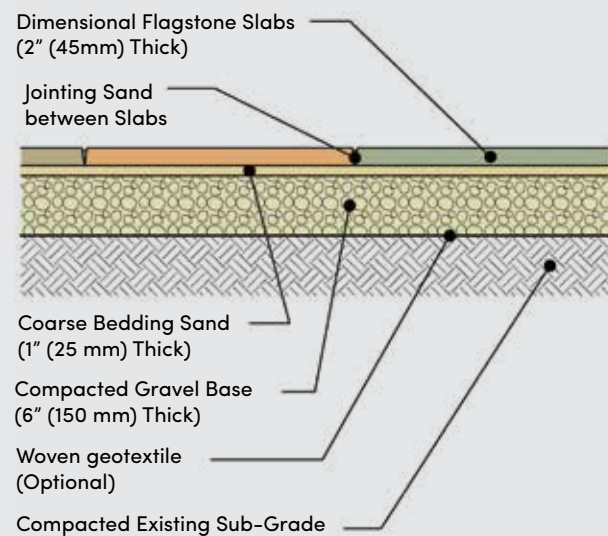

**WALKWAY LAYOUT**

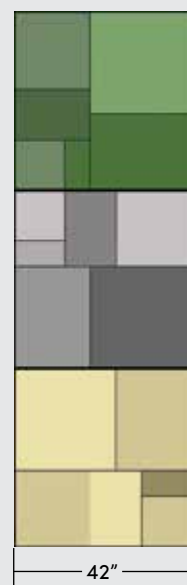

**PATIO LAYOUT**

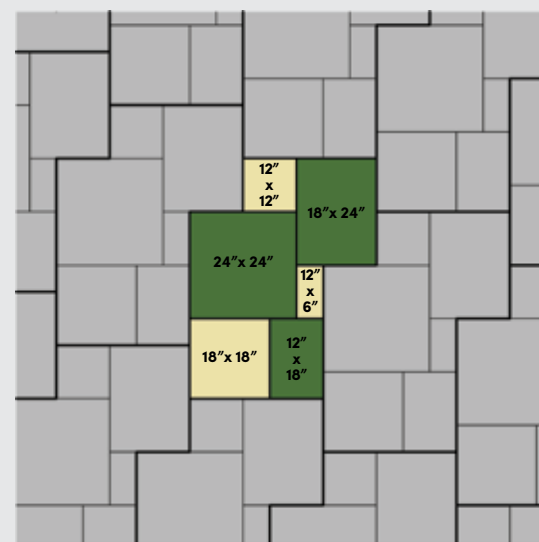







LINEAR FLAGSTONE



- Same size 21"x 10.5" pieces
- Consistent 2" thickness
- Pallet weight ± 2350 lbs (incl. pallet weight)
- Coverage = 98 sqft/pallet
- Units per bundle = 64
- Weight per stone = 37 lbs

*\*Not suitable for vehicular applications*

Stone & Bundling		Units	Unit Dimensions L" x W" x H"	Units Bundle	Weight/ Stone lbs
Old Mission	New Mission				
		6 x 9	5 <sup>11/16</sup> " x 8 <sup>1/2</sup> " x 2 <sup>3/4</sup> "	80	10 ±
		9 x 9	8 <sup>1/2</sup> " x 8 <sup>1/2</sup> " x 2 <sup>3/4</sup> "	40	15 ±
		12 x 9	11 <sup>5/16</sup> " x 8 <sup>1/2</sup> " x 2 <sup>3/4</sup> "	80	20 ±

- Available in three sizes and multiple face textures, each included on a single pallet
- Old Mission is suitable for both standard and permeable paver installation
- Suitable for residential vehicular traffic



Old Mission Pallet    New Mission Pallet

**PAVER PALLET**

- Pallet weight = ± 3050 lbs (incl. pallet weight)
- Coverage = 100 sqft/Pallet
- Section = 12.5 sqft per 1 layer
- 8 Layers per pallet
- 140 Linear feet in Soldier Course

**OLD MISSION**

**NEW MISSION**



Wider joint for permeable applications



Tighter joint for non-permeable applications

**Typical Paver Cross-Section**

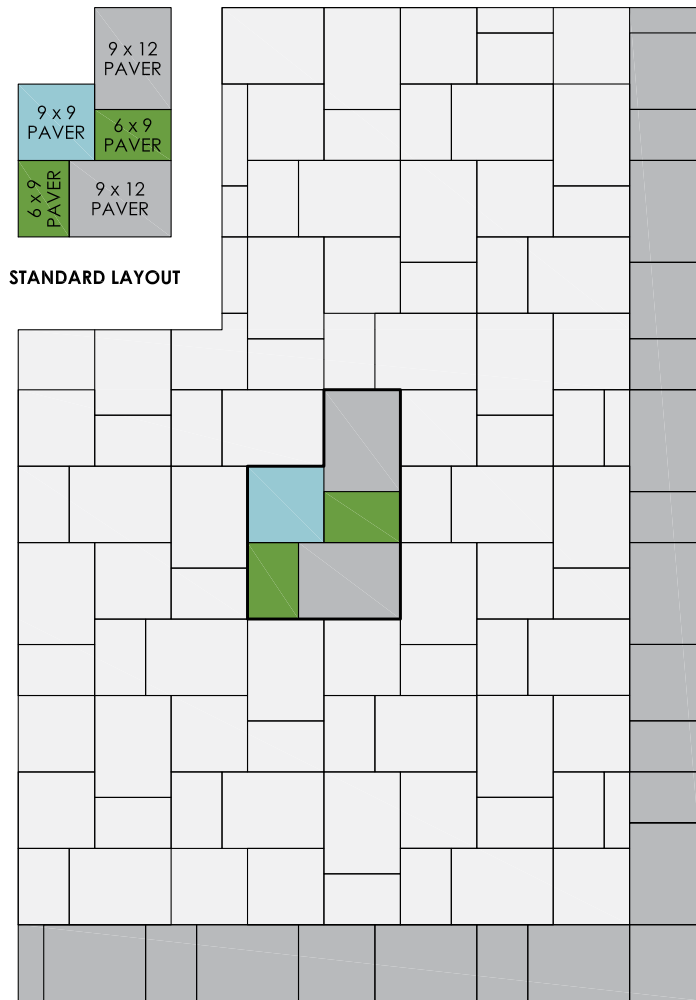
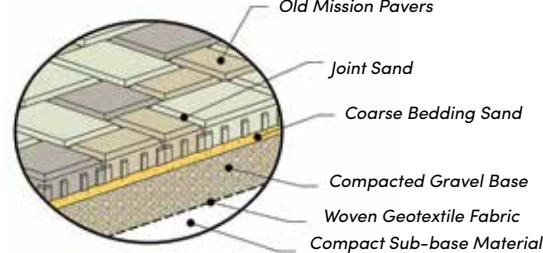

STANDARD LAYOUT

**Optional Soldier Course Using the Mission Paver Collection**  
A soldier course can be created around the edge of the paving by aligning Mission Pavers in the 9" nominal directions

AMARO PAVER

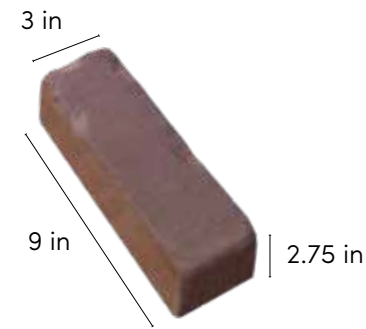

**PAVER PALLET**

- Pallet Weight = ± 2,300 LB (including pallet)
- Coverage = ± 72 SFT per Pallet
- Layers Per Pallet = 8 Layers
- Pavers Per Layer = 48 per Pallet
- Pavers Per Pallet = 384 per Pallet

**Linear Feet In Soldier Course:**

96 ft per Pallet

**Linear Feet In Sailor Course:**

288 ft per Pallet

**PATIO LAYOUTS**

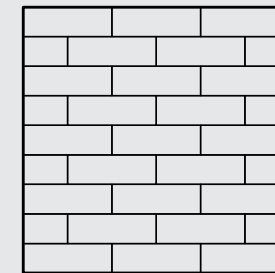

RUNNING BOND

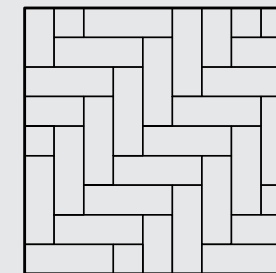

HERRINGBONE

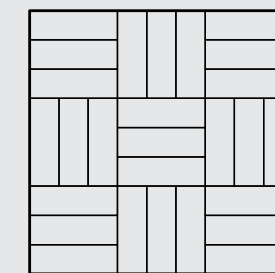

BASKET WEAVE

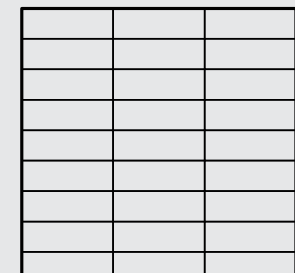

STACK BOND

AMARO PAVER CROSS-SECTION (on-grade installation)

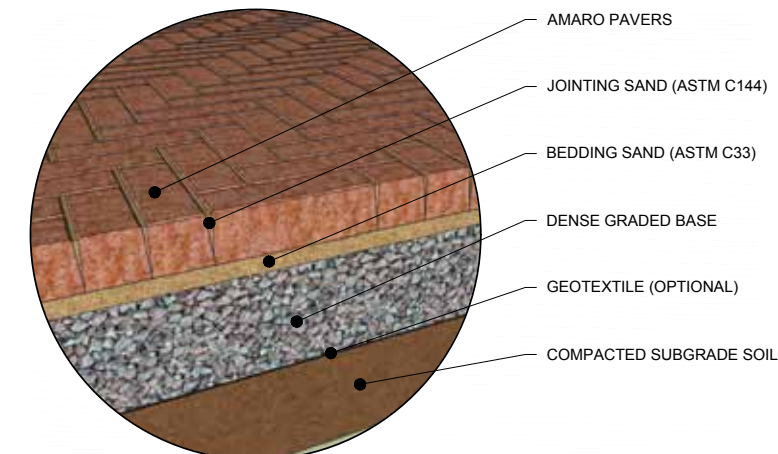

\*When snowplowing Amaro and Mission Pavers, a poly cutting edge must be used to avoid marking the surface of the paver.



Stone & Bundling	Unit Dimensions L" x W" x H"	Units Bundle	Weight/Stone lbs
 Miros	42" x 42" x 4"	6	600 ±

**MIROS**

- Largest format slab available
- Perfect for formal or modern applications
- Clean, crisp lines
- Lends itself well to moss, stone or accent pavers in joints
- Subtle stone texture
- Fast, mechanical installation

\*Not suitable for vehicular applications











Set slabs with Miros lifting device or properly rated nylon straps



**MIROS PALLET**

- Pallet weight = 3,650 lbs (incl. pallet weight)
- 6 pieces per pallet
- Coverage = 73½ sqft/pallet
- Section = 12 ¼ sqft per piece

Steppers	Unit Dimensions L" x W" x H"	Weight/Stone lbs
 Stepper 1	27" x 21" x 2"	78 lbs
 Stepper 2	27" x 21" x 2"	78 lbs
 Stepper 3	27" x 21" x 2"	78 lbs
 Stepper 4	27" x 21" x 2"	78 lbs

Steppers	Unit Dimensions L" x W" x H"	Weight/Stone lbs
 Stepper 5	27" x 21" x 2"	78 lbs
 Stepper 6	27" x 21" x 2"	78 lbs
 Stepper 7	27" x 21" x 2"	78 lbs
 Stepper 8	27" x 21" x 2"	78 lbs



**SUPERIOR STEPPERS PALLET**

- 16 pc/pallet (Random Assortment)
- Pallet weight = 1,300 lbs (incl. pallet weight)
- Coverage = 52 sqft/pallet
- Section = 3.25 sqft per 1 piece

**MIROS PAVER CROSS-SECTION**

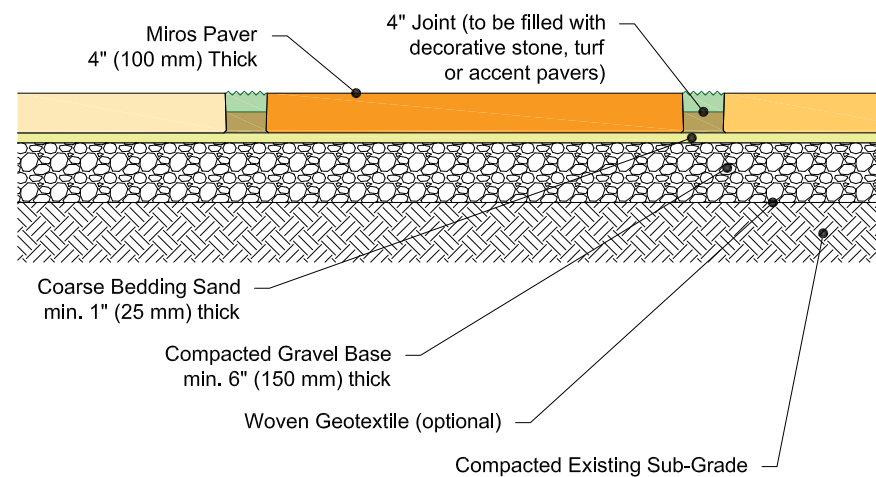



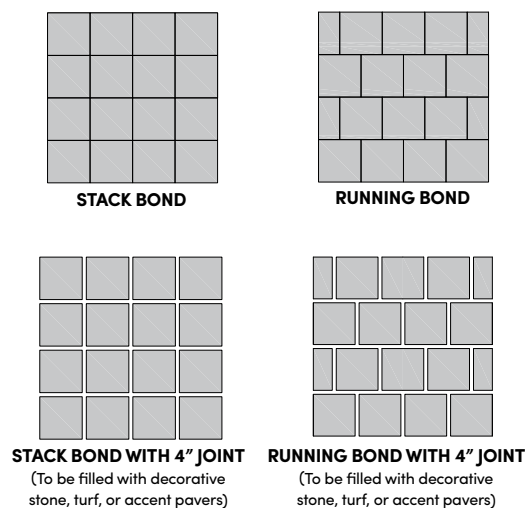

**PATIO LAYOUT EXAMPLES**

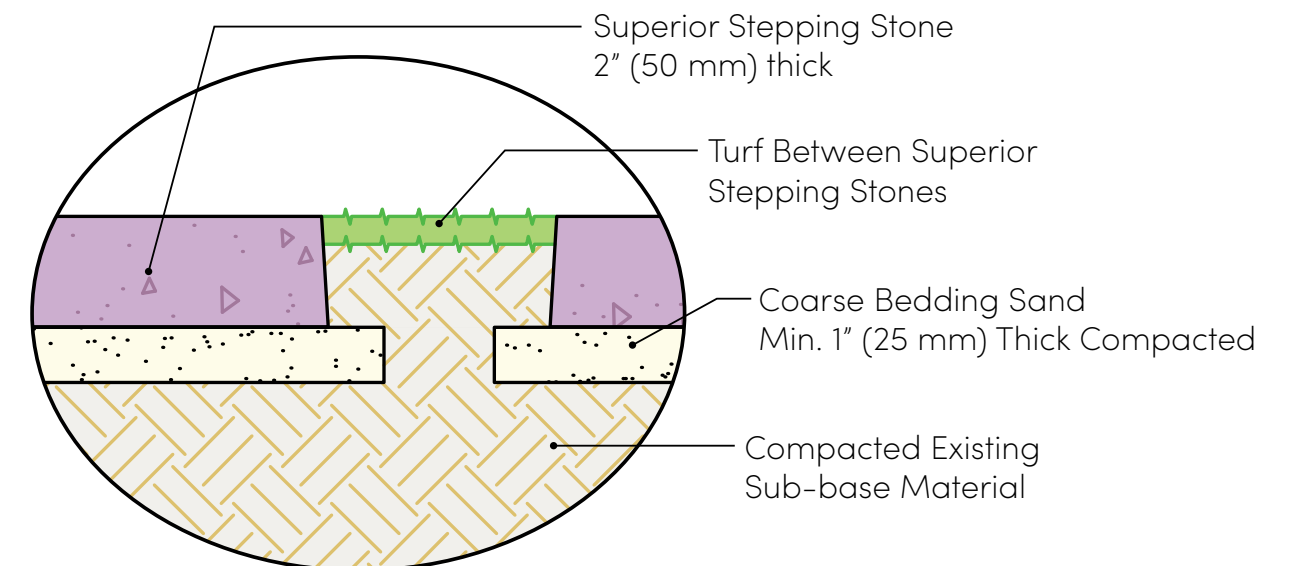

**TYPICAL CROSS-SECTION**



DIMENSIONAL STEPS

Stone & Bundling	Unit Dimensions L" x W" x H"	Unit Bundle	Weight/Stone lbs	Weight/Pallet lbs
 3'	36" x 18" x 7"	8	375 ±	3050 ±
 4'	48" x 18" x 7"	8	500 ±	4050 ±
 4' XL	48" x 24" x 7"	4	675 ±	2750 ±
 6'	72" x 30" x 7"	3	1333 ±	4000 ±

**36" x 18" DIMENSIONAL STEP PALLET**

- Pallet of 8 ea, 7" rise steps = 3,050 lbs









**6' DIMENSIONAL STEP PALLET**

- Pallet of 3 ea, 7" rise steps = 4,000 lbs



IRREGULAR STEPS







Stone & Bundling	Nominal Unit Dimensions L" x W"	Rise	Weight/Stone lbs
 Step A	54" x 24"	5 1/2"	391 ±
		7"	458 ±
 Step B	60" x 24"	5 1/2"	508 ±
		7"	600 ±
 Step C	42" x 17"	5 1/2"	289 ±
		7"	349 ±
 Step D	48" x 28"	5 1/2"	415 ±
		7"	567 ±
 Step E	42" x 26"	5 1/2"	390 ±
		7"	476 ±
 Step F	48" x 24"	5 1/2"	424 ±
		7"	512 ±



**IRREGULAR PALLET**

- Available in 5.5" or 7" rise
- Steps palletized in a random assortment
- Pallet of 8 ea, 5.5" rise steps = 3,300 lbs
- Pallet of 8 ea, 7" rise steps = 4,200 lbs



6' IRREGULAR STEPS

Stone & Bundling	Unit Dimensions L" x W" x H"	Weight/Stone lbs
Side A  Side B  Step 1	72" x 30" x 7"	1,300
Side A  Side B  Step 2	72" x 30" x 7"	1,300
Side A  Side B  Step 3	72" x 30" x 7"	1,300





**6' IRREGULAR PALLET**

- Steps palletized in a random assortment
- Pallet of 3 ea, 7" rise steps = 3,900 lbs

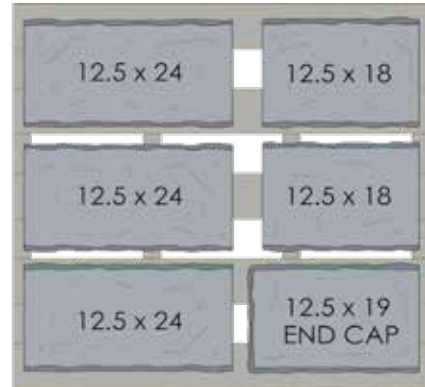
Stone & Bundling	Unit Dimensions L" x W" x H"	Units Bundle	Weight/Stone lbs
 24" Dimensional Coping	24" x 12.5" x 2.5"	18	63 ±
 18" Dimensional Coping	18" x 12.5" x 2.5"	12	47 ±
 Dimensional Coping End	19" x 12.5" x 2.5"	6	49 ±

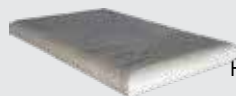

Stone & Bundling	Unit Dimensions L" x W" x H"	Units Bundle	Weight/Stone lbs
 Bullnose Standard	22" x 14" x 2"	18	50 ±
 Bullnose Right Corner	22" x 14" x 2"	9	50 ±
 Bullnose Left Corner	22" x 14" x 2"	9	50 ±

**Dimensional Coping Pallet**





- Pallet weight = 2,000 lbs
- 6 Layers per pallet
- 63 LF/pallet
- Section = 10.5 LF per 1 layer

**Bullnose Standard Pallet**

- Pallet weight = 950 lbs
- 3 Layers per pallet
- 33 LF/pallet
- Section = Sold by the piece

**Bullnose Corner Pallet**

- Pallet weight = 950 lbs
- 3 Layers per pallet
- 9 rights and 9 lefts
- Section = Sold by the piece

Stone & Bundling	Unit Dimensions L" x W" x H"	Units Bundle	Weight/Stone lbs
 27" Column Cap	27" x 27" x 2.5"	10	150 ±
 24" Column Cap	24" x 24" x 2.5"	10	120 ±
 30" Column Cap	30" x 30" x 3"	6	230 ±
 34" Column Cap	34" x 34" x 3"	6	295 ±

\*Belvedere coping, see page 7

FIREPLACE KIT COMPONENTS

COMPONENTS

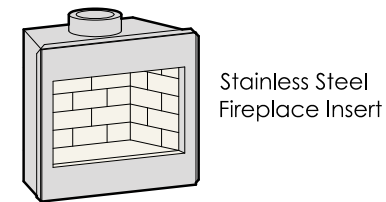
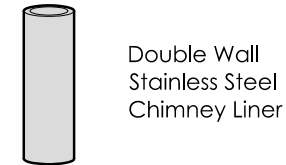

- Miscellaneous Fasteners
- Detailed Instructions

MASONRY COMPONENTS

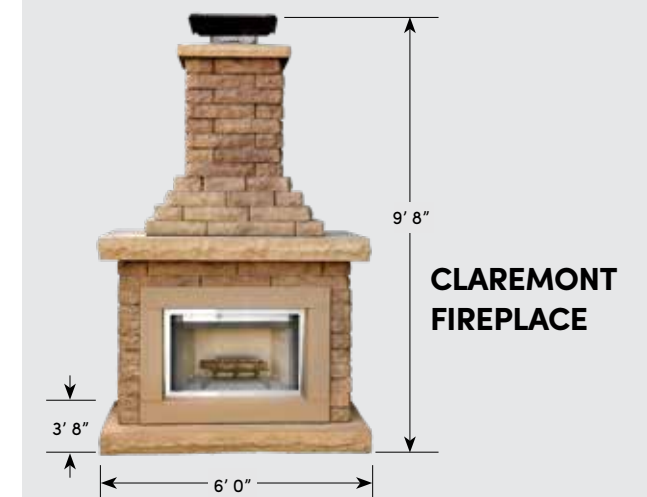
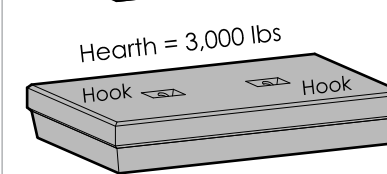
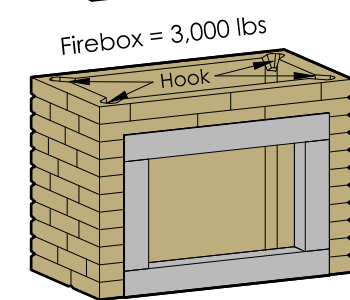
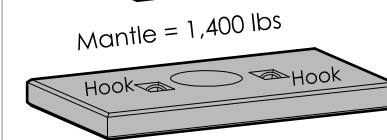
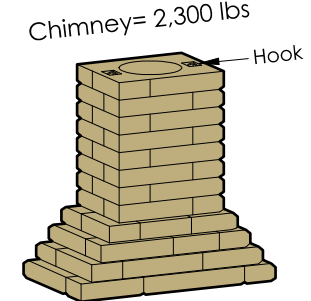
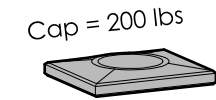

FOUNDATION INSTALLATION DETAIL

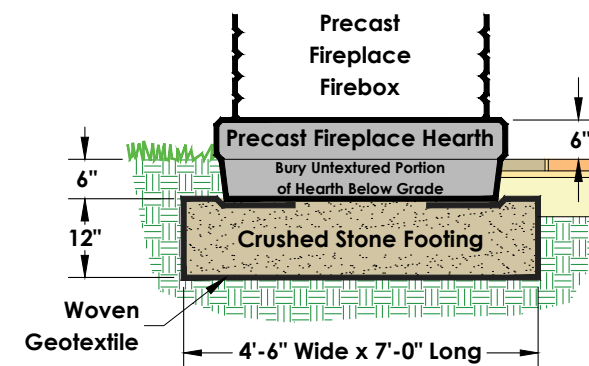

Visit [rosettahardscapes.com/technical-resources-by-product#TechFire](http://rosettahardscapes.com/technical-resources-by-product#TechFire) for more information on this product

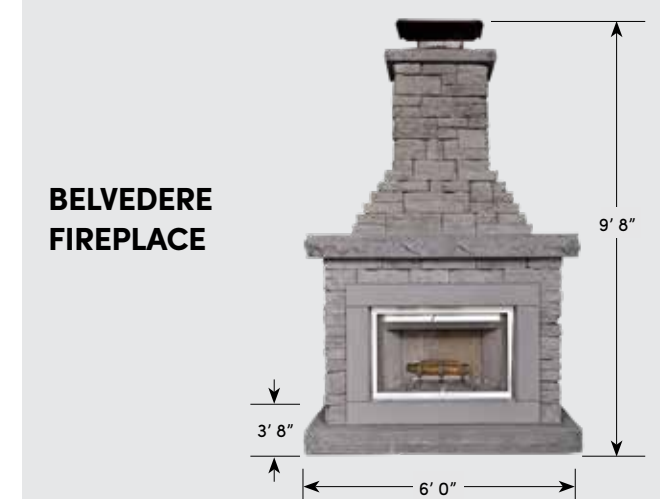

### BELVEDERE FIRE PIT KIT

Belvedere Fire Pit Kit Pallet: 1,320 lbs

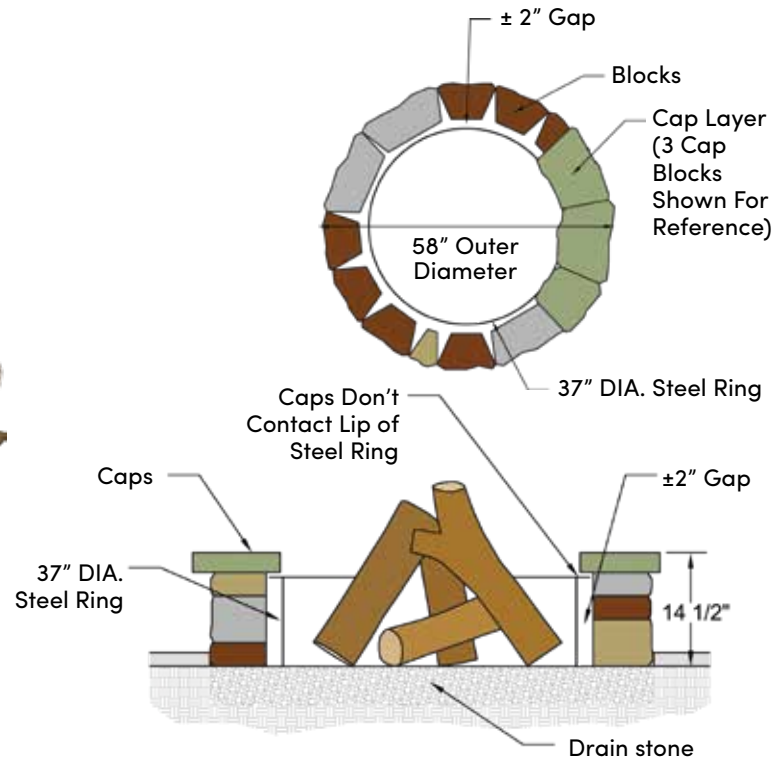

BLOCK LAYOUT PATTERN

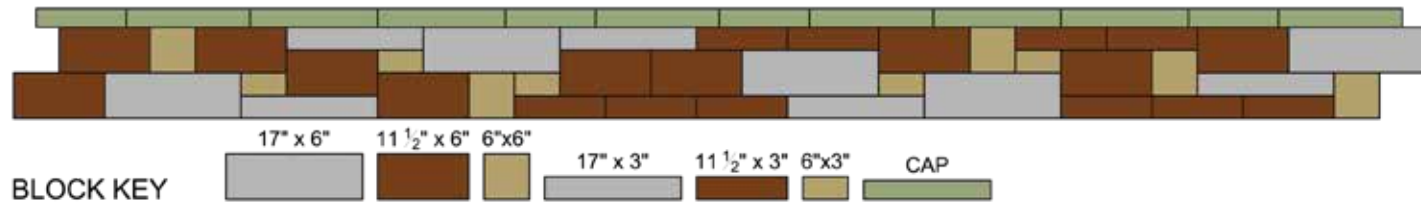

BLOCK KEY

### DIMENSIONAL FIRE PIT KIT

Dimensional Fire Pit Kit Pallet: 1,130 lbs

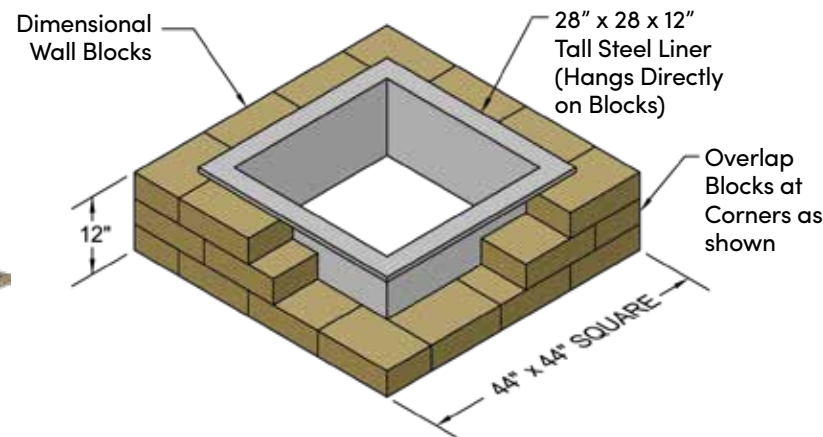

For more information visit  
[rosettahardscapes.com/technical-resources-by-product#TechFire](http://rosettahardscapes.com/technical-resources-by-product#TechFire)

### KODAH FIRE PIT KIT

Kodah Fire Pit Kit Pallet: 1,700 lbs

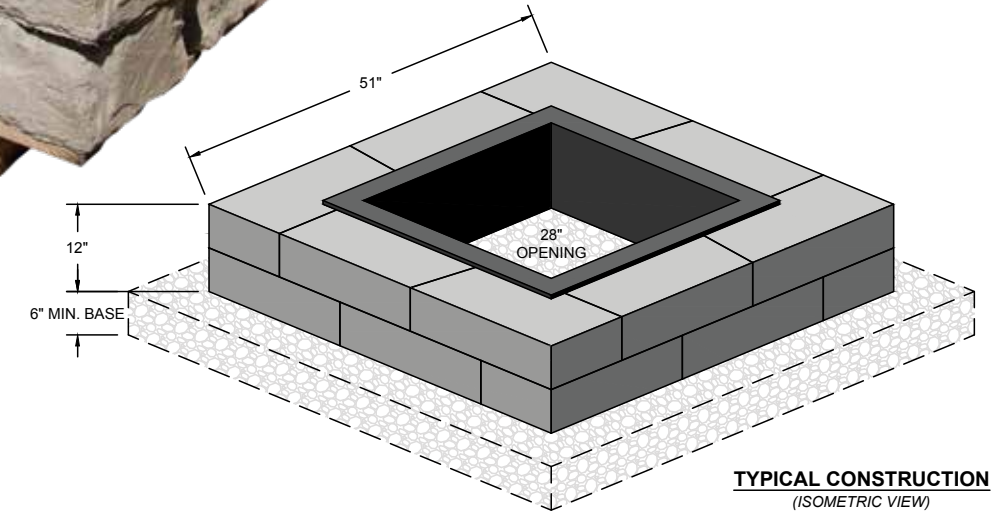
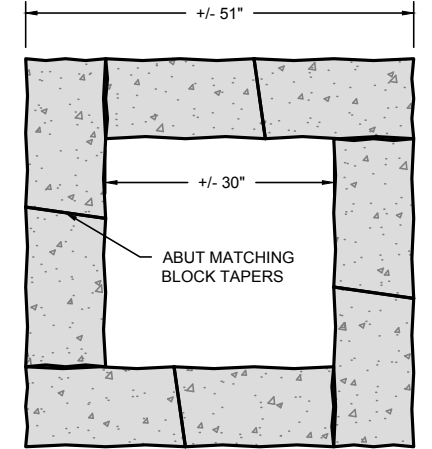

TYPICAL CONSTRUCTION  
(ISOMETRIC VIEW)

#### INSTRUCTIONS: For both Round & Square Fire Pit Kits

1. Familiarize yourself with the construction details shown on this page.
2. Mark out the location for your fire pit. Note dimensions shown are nominal so mark an area slightly larger than shown.
3. Excavate for drain stone base (approx. 6")
4. Fill excavation with drain stone, level, and compact.
5. Place and center steel ring on prepared base.
6. Place blocks per the pattern. (For Round Kit, keep Blocks 1 1/2" off steel ring)
7. WARNING: Do not place Rosetta Fire Pits directly on Rosetta Flagstone product or any comparable concrete product or slab as high heat can adversely affect the integrity of the product.

#### ADDITIONAL INSTRUCTIONS FOR ROUND FIRE PIT ONLY

8. After placing blocks around the ring, adjust the blocks in or out to make the circle close and fit tight. If the blocks do not close the circle, move all blocks slightly in. If the blocks seem too long, move the blocks slightly out.
9. Place caps in circle around fire pit. Adjust the caps in or out to make them fit tightly together.
10. Note: Not suitable for large fires. Fire size should not allow flame to contact Caps on Round Fire Pit.

#### Gas conversion kits are available for both Round and Square Fire Pit Kits.



**ROSETTA RETAINING WALL INSTALLATION NOTES**

Thank you for your interest in installing a quality retaining wall system by Rosetta Hardscapes. The following guide describes proper installation techniques for the Rosetta Outcropping, Kodah, Belvedere, Dimensional, and Claremont Wall systems. This installation guide will help cover the basic steps required to construct a beautiful, structurally sound retaining wall. For optimal color blending you must mix and install products from several different pallets simultaneously.

**PRE-CONSTRUCTION CHECKLIST**

Before you start construction, take the time to complete the necessary planning and preparation. This process will keep your project running efficiently and will aid in completing a quality installation. Make sure to address the following:

**SAFETY**

Your safety program should address items such as personal protective equipment, maintaining safe slopes and excavations, fall protection, rigging and lifting, as well as any other relevant safety precautions.

**ENGINEERING AND PERMITS**

Obtain the necessary engineering design and permits for your project. The soils for foundation and wall backfill should be properly evaluated by a trained professional. Unsuitable soils should be removed and replaced as recommended.

*Note: This installation guide is intended to supplement a detailed, site-specific wall design prepared by a Professional Engineer. The construction documents for your project supersedes any recommendations presented here.*

**REVIEW THE PROJECT PLANS**

Take the time to review and understand the project plans and specifications. Make sure you understand the detailed design for the project before starting construction. A pre-construction meeting with the wall designer, construction inspector, wall contractor, and owner or representative is recommended. Don't be afraid to ask questions.

**CONSTRUCTION PLANNING**

Develop a plan to coordinate construction activities (material delivery/storage, equipment access, etc.) on your site. Make sure your plan specifically addresses how to control surface water during construction.

**For the most natural appearance, install products from multiple pallets simultaneously. This will create a more blended, natural look.**

**UTILITY LOCATION**

Make sure to have underground utilities located and marked on the ground before starting any construction.

Call 8-1-1 or go online to call811.com to schedule utility marking for your project site.

**MATERIAL STAGING**

Store retaining wall blocks in a location close to the proposed wall. Blocks should be kept clean and mud free. Blocks should also be stored in a location which will minimize the amount of handling on the project site.

Store geogrid in a clean, dry location close to the proposed wall site. Keep the geogrid covered or in the shade until installation to avoid exposure to direct sunlight.

**EQUIPMENT**

Make sure you have the proper equipment to handle retaining wall blocks and pallets on the construction site (Note: A specially designed Rosetta Lifting Device is required for the installation of Rosetta Outcropping blocks).

Hand operated equipment used in wall construction should include shovels, rake, 2' (600 mm) level, 4' (1.2 m) level, broom, hammer, chisel, tape measure, string, spray paint, laser level, pry bar, concrete saw and a walk behind vibratory plate compactor capable of delivering a minimum of 2000 lb (9 kN) centrifugal force.

Personal protective equipment should include appropriate clothing, steel toe boots, eye protection, respiratory protection, hard hat, gloves, hearing protection, fall protection, rigging, and other items as necessary to insure a safe working environment.

**BASE PREPARATION**

Proper base preparation is a critical element in the construction of your retaining wall. Not only is it important to provide a stable foundation for the wall, but a properly prepared base will greatly increase the speed and efficiency of your wall installation.

Proper base preparation starts with the sub-grade soils (soils below the leveling pad). Existing soils must be removed to the bottom of the leveling pad elevation for the retaining wall. A typical wall requires excavation of at least 12" (300 mm). This will provide 6" (150 mm) for the leveling pad and 6" (150 mm) of minimum bury of the blocks. (Note: excavation and bury depth will vary by product type and design. Please see project plans or product specific information for further information.) At a minimum, all topsoil, organic, unsuitable soils should be removed from below wall. The minimum width of the leveling pad should be 18" (465 mm) wider than the width of the block. This will provide 6" (150 mm) in front of and 12" (300 mm) behind the bottom block.

Once excavated, the sub-grade soil should be compacted to a minimum of 95% maximum density as determined by a standard proctor test (ASTM D698). At this point the soil should be firm, dry and free of topsoil debris, stones, roots, etc. Consult a soils engineer if in doubt. Any unsuitable material shall be excavated and replaced as directed by the engineer.

**LEVELING PAD**

Base preparation continues with proper leveling pad construction. An open graded (free-draining) crushed stone leveling pad is typically used for retaining walls. Walls can also be designed with a dense-graded crushed stone or concrete leveling pad. The choice of which type of leveling pad to use is made by the wall designer and depends on several factors including the bearing capacity of the native soil, location of the drain outlet, conditions at the base of the wall, and any other special considerations for the wall.

The leveling pad material should be placed and compacted to provide a uniform, level foundation on which to construct the retaining wall. Proper elevation can be established with a laser level or transit. Check for level both parallel and perpendicular to the wall.

Place and compact leveling pad material as specified in the wall design. If crushed stone is used, place the stone in uniform loose lifts a maximum of 6" (150 mm) thick. Lift sizes are relative to size of the compactor being used. Compact the stone with a minimum of three passes with a 24" (600 mm) wide, walk-behind, vibrating plate compactor.

*NOTE: Do NOT place a thin layer of sand between the leveling pad and bottom block. This layer will reduce the sliding resistance between the leveling pad and bottom block, as well as reduce the drainage capacity of the foundation stone.*

**DRAIN**

A drain is installed in the lowest part of the open graded (free-draining) stone behind the retaining wall. If an open graded crushed stone leveling pad is used, the drain is installed on the bottom of the crushed stone leveling pad. If a dense graded crushed stone leveling pad is used, the drain is installed immediately on top of the dense graded stone.

Typically, a 4" (100 mm) diameter perforated "sock" pipe is used. Daylight the drain pipe at the ends and/or through the face of the wall every 50' to allow for drainage. The pipe can also outlet into a nearby drainage ditch or catch basin. Because water can flow both ways through the drain pipe, connection to a catch basin or active storm sewer should only be made under the direction of a Professional Engineer.

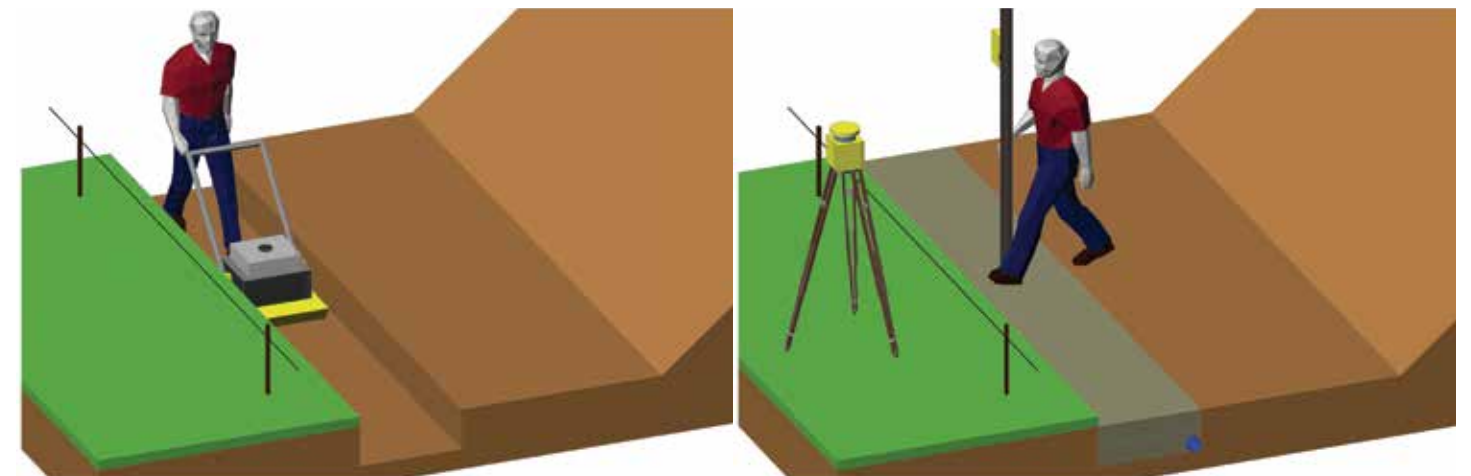

### SETTING THE BOTTOM COURSE OF BLOCKS

Proper placement of the bottom course of wall stones is critical in determining the overall appearance and integrity of the finished project. Take extra time on this step and the rest of the project will go smoothly. At this point you need to determine the best point of origin for the wall. If you have a fixed point, such as a building corner or a 90° corner, you will want to start the wall from that point and work your way out. This will minimize cutting of blocks. If there are no fixed points, start the wall at the lowest design elevation, as it is easier to step the base up than it is to step the base down.

Properly mark the location of the retaining wall. A string line or offset stakes are typically used to establish horizontal and vertical alignment.

Where applicable, remove the bottom lip from the back edge of the blocks with a hammer and chisel (bottom course of blocks only) so the blocks will lie flat on the leveling pad.

Place a complete row of blocks on the prepared leveling pad. Blocks should be placed tight together.

Check all blocks for level from front to back and side to side as they are placed. Place and compact backfill in front of the bottom row of blocks to help hold them in place. Compaction should be to 95% maximum density as determined by a standard proctor test (ASTM D698).

Place open-graded crushed stone, between the blocks, and at least 12" (300 mm) behind the wall. A stone meeting the gradation requirements of ASTM No. 57 with no material passing the No. 200 sieve is preferred. Place the stone in uniform loose lifts a maximum of 8" (200 mm) thick. Fully consolidate the stone. Carefully hand tamp the stone within 12" (300 mm) of the blocks.

### SETTING THE UPPER COURSES OF BLOCKS

Placing the next course of blocks is similar to placing the first course. Blocks should be placed to establish a running bond pattern (Rosetta Dimensional Collections) or to follow an irregular pattern (Rosetta Outcropping, Belvedere, and Claremont Collections).

Blocks should be installed with their sides pushed tight. Push blocks from Rosetta Outcropping collections forward until the lip on the back of the block comes in full contact with the blocks below. Make sure that no stones get caught or wedged between the lip and the back of the blocks below. Walls without the lip on the bottom (Rosetta Belvedere, Dimensional, Kodah Freestanding, and Claremont Collections) should not be stacked exactly vertical. Instead, they should be set back as specified by each product line.

**Rosetta Outcropping:** Place a layer of non-woven geotextile fabric directly behind the blocks. This will keep materials from eroding through the small voids between the blocks.

Place Geogrid reinforcing behind the wall as specified in the project documents. See geogrid Installation information in the next section for further details.

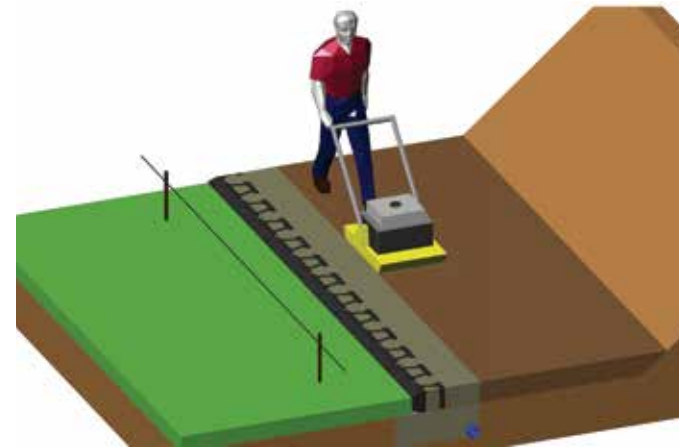

Place non-woven geotextile fabric between the drainstone and the remaining backfill material if specified.

Backfill behind the drainstone with material as specified in the project design. Place the material in loose lifts as specified, but not to exceed 8" (200 mm) maximum. Granular backfill shall be compacted to a minimum of 95% maximum density as determined by a standard proctor test (ASTM D698). Do not use any organic, topsoil, frozen, soft, wet, or loose soils when backfilling the wall.

Re-check all units for level and alignment and sweep the top of each course of blocks clean before starting construction of the next course.

Place and compact open-graded crushed stone in the cores of the blocks, between the blocks, and at least 12" (300 mm) behind the wall following the procedure used for the bottom course of blocks.

Place non-woven geotextile fabric between the drainstone and the remaining backfill material if specified.

Place and compact backfill behind the drainstone following the procedure used for the bottom course of blocks.

Re-check all units for level and alignment and sweep the top of each course of blocks clean before starting construction of the next course.

Repeat these steps with each course of blocks to the top of the wall.

### GEOGRID INSTALLATION

Stability of reinforced soil walls rely on the interaction between geogrid reinforcement, soil in the reinforced zone, and the retaining wall blocks. It is very important that reinforced soil walls be constructed per the detailed design prepared by a Professional Engineer. Make sure you are using the proper type and strength of geogrid listed in the design. The geogrid layers need to be placed at the proper elevations and to the proper distances into the reinforced soil zone detailed in the design. It is also critical to use the appropriate backfill soil material in the reinforced soil zone.

Construct the wall up to the elevation of the geogrid layer shown in the design.

Place geogrid layers as shown in the project details extending into the reinforced soil zone to the design length.

Geogrid must be installed with the strong direction (roll direction) into the reinforced soil zone and not parallel to the wall. Geogrid must be placed in a continuous sheet throughout its length from the connection at the blocks to the back of the reinforced zone. Do not splice or overlap the geogrid.

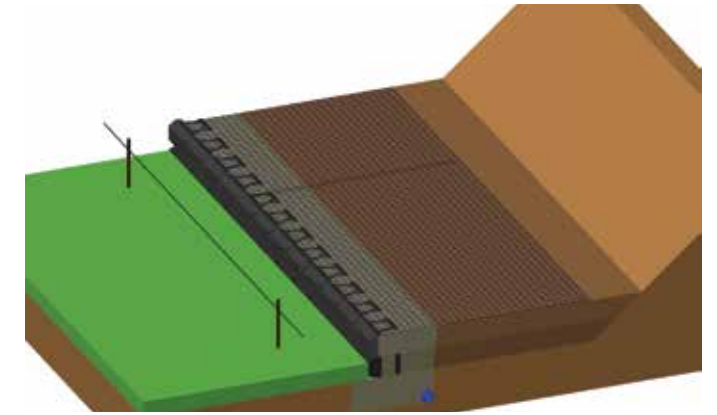

For all retaining wall products except the Rosetta Outcropping Collection, use the next layer of blocks to secure the front end of the geogrid. Make sure the geogrid is as close as possible to the front face of the wall without being visible. Pull the geogrid taut to eliminate any folds and pretension the geogrid. Pin or secure the back edge of the geogrid before placing the reinforced fill.

### FINISHING THE TOP OF THE WALL

Completing a few simple tasks near the end of the project will ensure that the wall will function properly and look good for years to come.

Grade the top of the wall in such a way that surface water runs off away from the wall. Never leave the top of a wall graded where surface water will pond behind the wall, or saturate the backfill soils.

Place a layer of non-woven geotextile fabric over the top of the drainstone at the back of the wall. This will keep topsoil from migrating into the drainstone and causing problems.

If required, place the coping layer on the top of the wall. The coping blocks should be placed towards the front edge of the wall blocks and should sit securely on top without tipping forward under their own weight. The coping layer should be carefully adhered with a concrete adhesive specifically formulated for segmental concrete block wall construction.

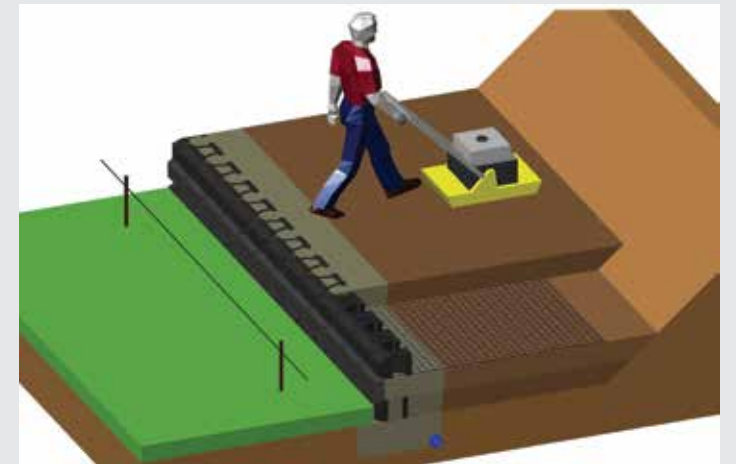

### MORE INFO

Refer to product specific *Typical Construction Details* for specific applications and construction practices such as chimney drain construction, fence installation, corner construction, drain placement, curve construction, and other details.

Typical allowable construction tolerance at the wall face is 1" in 10' (1:120) in the vertical and horizontal directions, and a rotation tolerance of 2° from wall batter.

Once you commence working, continue without interruption or delays. This will help expedite construction and minimize the time the excavation is open.

If at any time ground water seepage is observed along the exposed excavation behind the retaining wall, contact the wall designer immediately to determine the corrective action needed.

The construction site should be graded and maintained to direct surface water runoff away from the retaining wall throughout the entire construction process. If there is a rain event with surface water runoff producing erosion or scour near the retaining wall, contact the wall designer immediately to determine the corrective action needed.

## RETAINING WALL

### TYPICAL GRAVITY WALL SECTION

This page shows typical construction details for Gravity walls. These drawings are representative of major components required in wall construction. Specific details including geotextile reinforcement layers, drainage details, soil requirements, etc shall be per engineered design for wall. For more cross-section and design options, please visit [rosettahardscapes.com](http://rosettahardscapes.com) and click on Tech Resources

**NOTE:** Block size and placement shown are for reference only. Individual Rosetta blocks will vary with installation pattern. Actual design must be performed by licensed engineer.

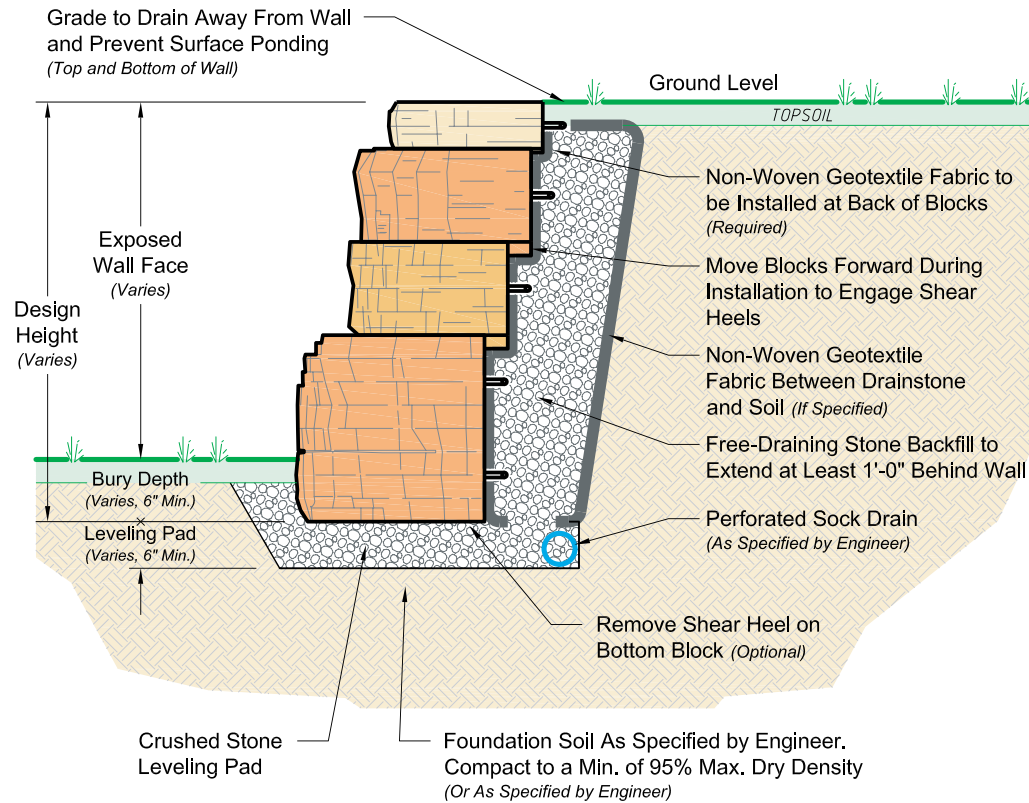

### TYPICAL FREESTANDING WALL

This page shows typical construction details for Outcropping Freestanding walls. These drawings are representative of major components required in wall construction. Specific details including drainage details, soil requirements, etc shall be per engineered design for wall.

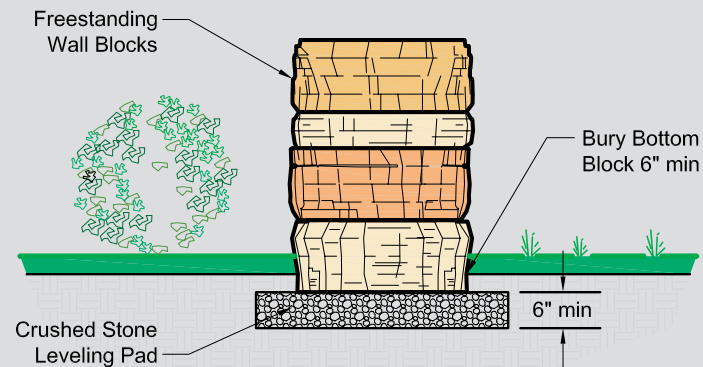

Block size and placement shown are for reference only. Individual Rosetta blocks will vary with installation pattern.

### FREESTANDING WALL PATTERNS

4' x 10' Freestanding Wall Section  
(2x Pallet D, 2x Pallet E)

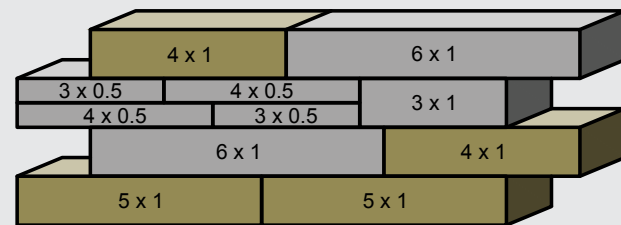

90° Freestanding Wall Corner  
(4x Pallet D, 4x Pallet E)

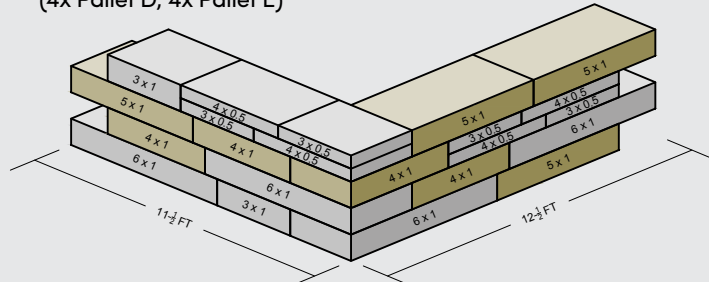

### Outcropping Notes For Installations Requiring Geogrid:

Please visit [rosettahardscapes.com](http://rosettahardscapes.com) for detailed cross-sections of geogrid reinforced Outcropping walls. For Rosetta Outcropping installations, do not overlap geogrid over top of blocks. Instead, run the geogrid directly up to the back of the blocks. In addition to this reinforcement, a Paraweb strap must be installed through each lifting hook in the back of the Outcropping blocks. Please see standard details for *Reinforced Outcropping Walls* for further information.

Place and compact drainstone and reinforced fill following the procedure used to set the bottom and upper courses of blocks. It is important to place and compact stone and reinforced fill starting at the back of the retaining blocks and extending into the reinforced soil zone. This will help eliminate "bunching" of the geogrid reinforcement.

Reinforced zone fill material is typically a sand or gravel with less than 5% "fines" (material passing the No. 200 sieve). This material is usually classified as a GW, GP, SW, or SP. It is very important that you only use the fill material specified in your project design drawings and specifications.

Place retained soil immediately between the reinforced soil zone and the back of the excavation. Material should be placed in loose lifts of 8" (200 mm) maximum and compacted to 95% maximum density as determined by a standard proctor test (ASTM D698). Bring the reinforced and retained soil up to grade at the same time. At no time should the elevation of the reinforced soil be more than 1 block higher than the retained soil.

Tracked construction equipment should not be used directly on the geogrid. A minimum of 6" (150 mm) of fill is required between tracked equipment and geogrid to prevent damage to the grid. Rubber-tired equipment may pass over the geogrid when traveling at low speeds of 5 mph (8 km/h) or less. Avoid any sudden stopping or turning of construction equipment in the reinforced fill zone to prevent moving or damaging the geogrid layers.

Follow geogrid manufacturer's requirements, including requirements for vertical separation and overlap of geogrid.

**For All Installations**  
Never stack blocks more than one course above grade of backfill.

### Outcropping Layout Notes:

One of the unique features of the Rosetta Outcropping system is multiple block heights. To provide a uniform wall batter with multiple height blocks, the set-back of the blocks varies proportionally with the block height. The setback in blocks is achieved with shear heels which are cast into the Rosetta blocks. For a 6" high block, the shear heels are 1.5" deep (1/2 times 3"). For a 12" high block, the shear heels are 3" deep (1 times 3"). For a 24" high block, the shear heels are 6" deep (2 times 3").

To ensure proper wall alignment and to account for the multiple height blocks and varying setbacks, you have to adjust the bottom row of blocks based on their height. Setup a traditional string line for the back of the wall, then offset the blocks per the following figure.

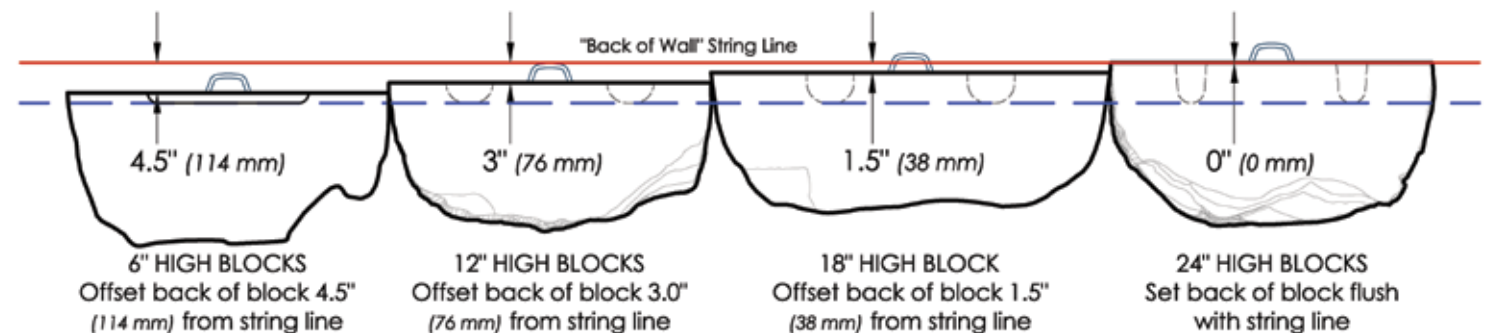

### Outcropping Lifting Device

Outcropping lifting device required for proper installation



Rosetta Blocks have shear heels to help with wall integrity and provide a setback from lower blocks in the wall, this causing the wall to batter back. The batter is important to the engineering design to the wall, and it must be accounted for during construction of a curved wall section.

If you are constructing an **outside** (convex) curve, the wall batter will cause the blocks higher in the wall will have a shorter radius around the curve than lower blocks. This will cause the higher blocks to “grow” in the wall layout pattern. (This is similar in concept to the inside lane of a race track is shorter than the outside lane). The result is a potential overlap between some of the blocks in the wall. The best way to deal with this overlap is to saw cut the end of the smaller block, which allows the blocks to fit tight together and all the shear heels to be properly engaged. This saw cut is typically made on an angle to match the taper on the block you are abutting.

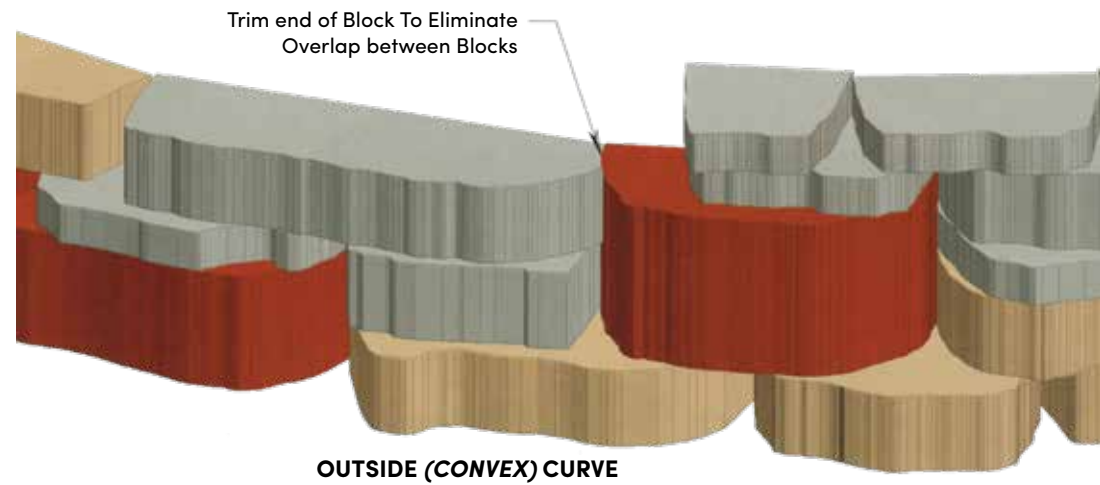

If you are constructing an **inside** (concave) curve, the wall batter will cause the block higher in the wall will have a longer radius around the curve than lower blocks. The important step when constructing a inside curve is to keep all blocks tight together. In most cases, the blocks will touch somewhere along the sides of the blocks, not at the back of the blocks. If needed, you can trim the ends off some blocks to prevent gaps from opening up between blocks. When constructing a curve with a short radius, voids may form at the back of the wall where two blocks meet. If this happens simply fill the void areas with filter fabric and drainstone.

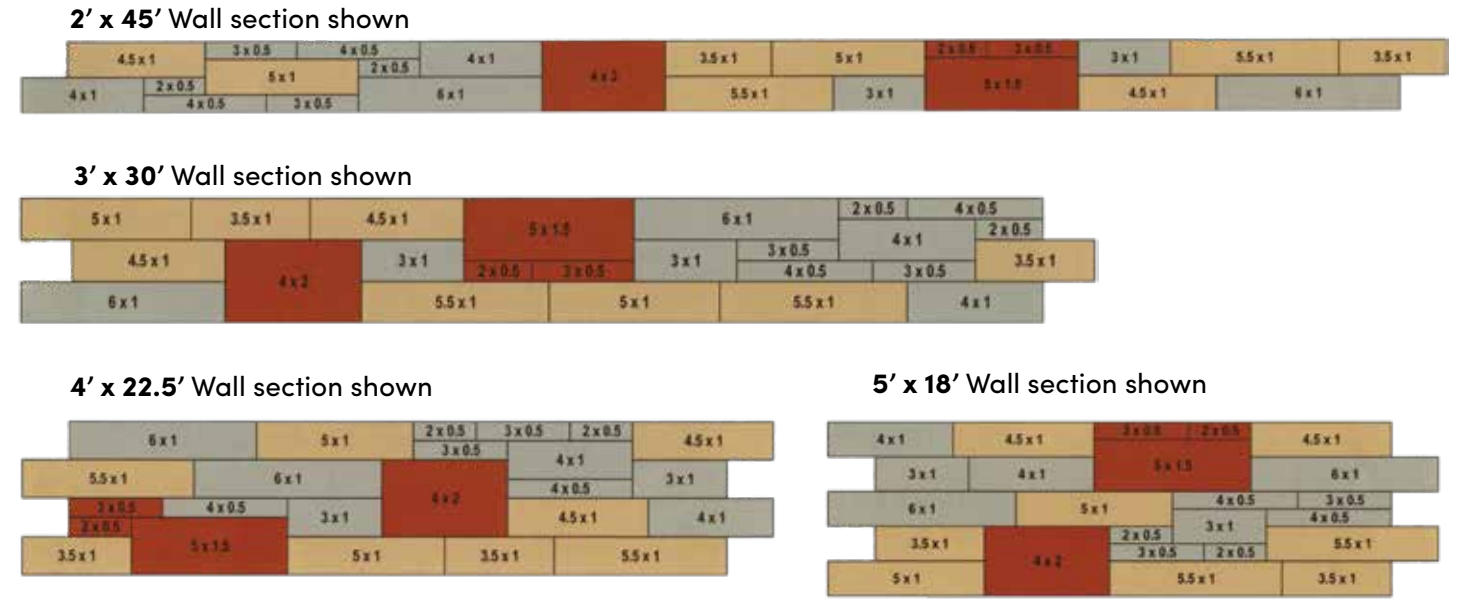
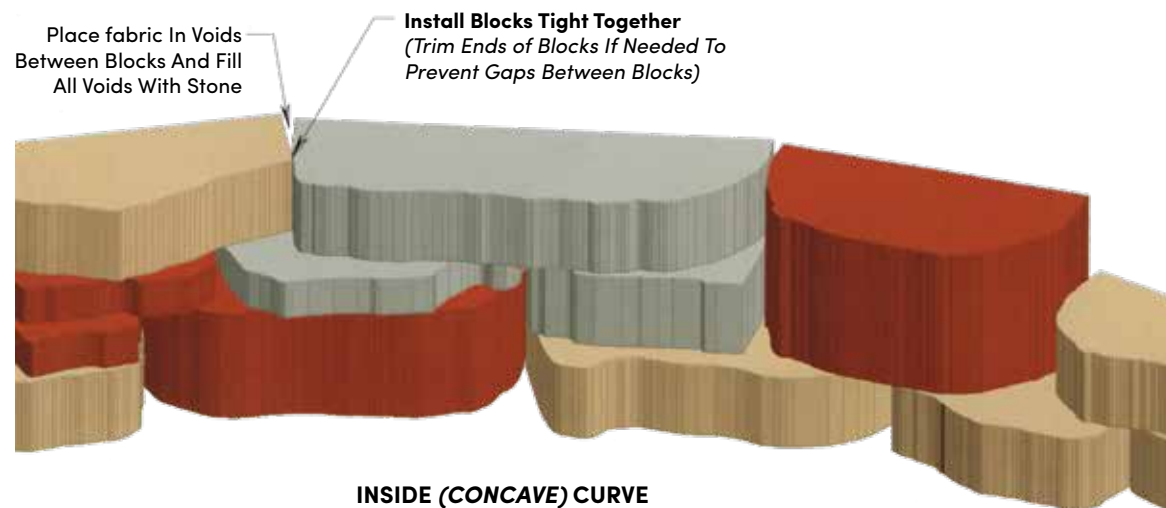

Please note that the length dimensions shown for Rosetta blocks are rounded for reference. The actual length of the constructed wall will vary slightly from the pattern dimensions shown. Each pattern is made up of (2) A Pallets, (2) B Pallets, and (1) C Pallet.

Rosetta has two corner blocks to help make a 90° corner in the wall. The corner blocks are four-sided, and can be installed with alternating faces exposed to maintain a more random look.

The size of the corner blocks have been chosen to account for the wall batter in both directions. Two 6" high corner blocks are typically stacked on top of each other and placed on top of a 12" the corner blocks are intended to be stepped back 3" in both directions. In a few areas, you may need to trim a small part of the corner blocks near the back of the wall to avoid interference with the shear heels on adjacent blocks. See the sample pattern shown here, which details how to make a 90° corner with (4) A pallets, (4) B Pallets, (2) C Pallets, (3) 12" high corner blocks, and (4) 6" high corner blocks.

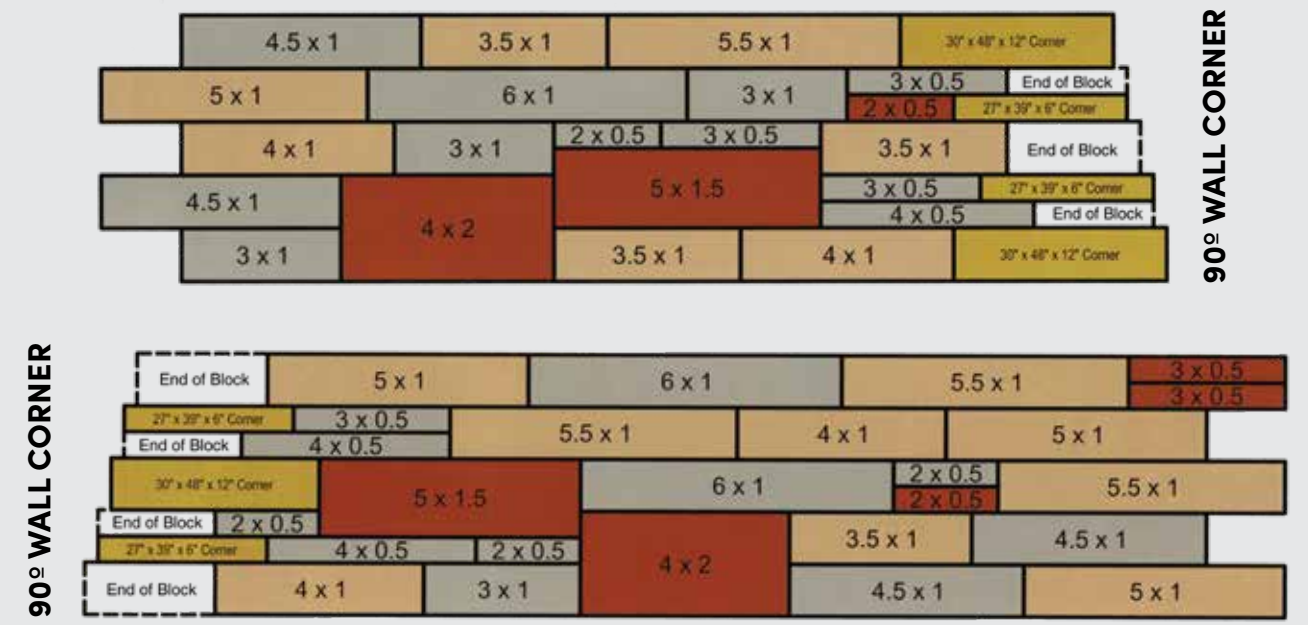



**TYPICAL RETAINING WALL CONSTRUCTION DETAILS**

This page shows typical construction details for Belvedere retaining walls. These drawings are representative of major components required in wall construction. Specific details including geotextile reinforcement layers, drainage details, soil requirements, etc. shall be per engineered design for wall.

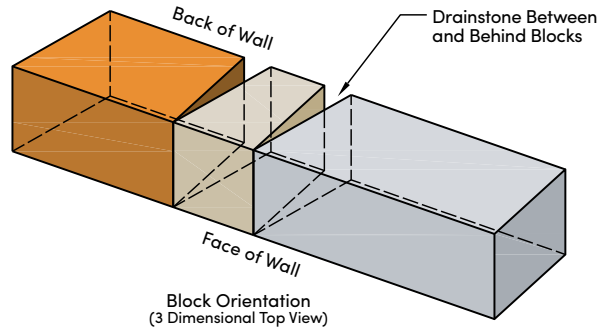

- This drawing is for reference only.
- Final design for construction for must be prepared by a registered Professional Engineer using the actual conditions of the proposed site.
- Final wall design must address both internal and external drainage and shall be evaluated by the Professional Engineer who is responsible for the wall design.
- Block size and placement shown are for reference only Individual Belvedere blocks will vary with installation pattern.

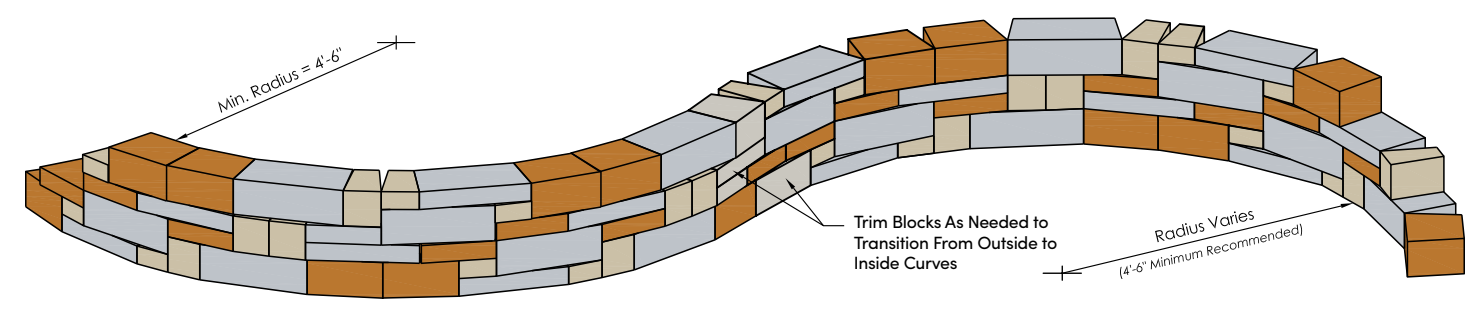
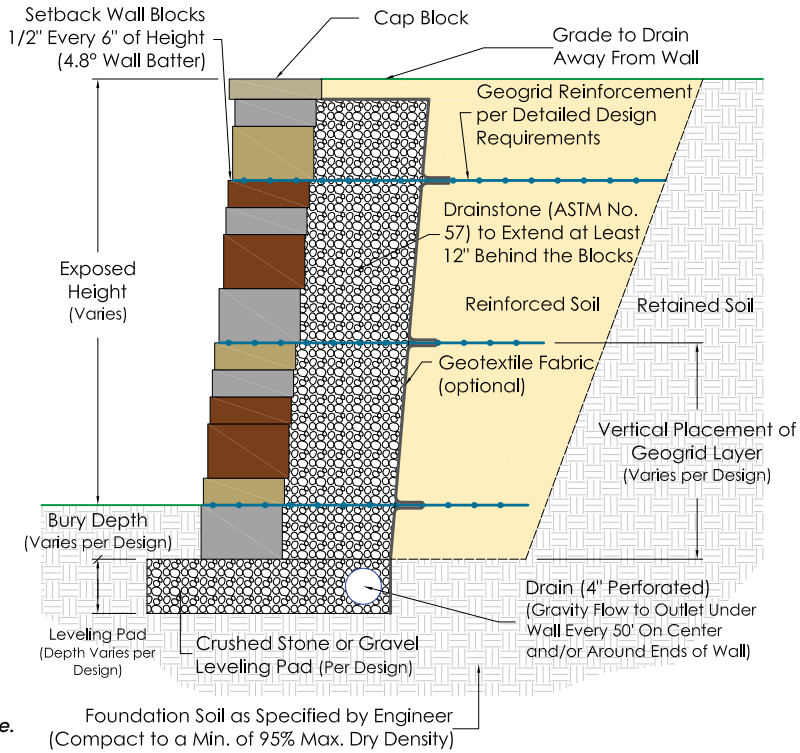

**OUTSIDE CURVE**

**INSIDE CURVE**

This page shows typical construction details for making curved retaining walls with Belvedere blocks. The taper on the side of the blocks allow for construction of a wide range of curves in both retaining and freestanding walls.

**Notes:**

1. These details show curved retaining walls.
2. Minimum radius curves are shown which can be constructed without saw cutting a significant number of blocks. Larger radius curves can be created by leaving a larger gap between blocks on the back side of the wall. The gaps must be filled with drainstone.
3. When retaining walls are constructed with batter, the radius on outside curves becomes smaller with each course due to the block setback. For proper construction, the radius of the bottom course must be larger than the minimum radius so upper courses will have sufficient room for construction.
4. When retaining walls are constructed with a batter, the radius on inside curves becomes larger with each course due to the block setback.

**FREESTANDING WALL**

**TYPICAL FREESTANDING WALL CONSTRUCTION DETAILS**

Belvedere freestanding walls are intended to be low walls (24" or lower) used in a garden or patio setting. Taller walls, walls intended to act as railing or barriers, walls constructed in other settings, or walls subject to applied loads will require project specific engineering.

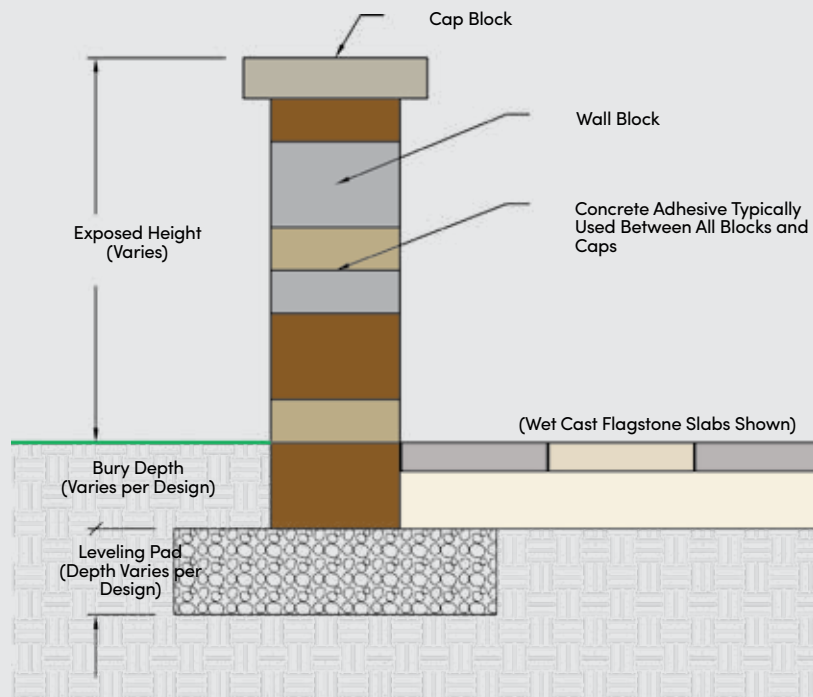
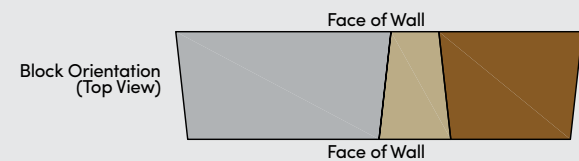

- This drawing is for reference only.
- Final design for construction for walls subject to any loading must be prepared by a registered Professional Engineer.
- Block size and placement shown are for reference only individual Belvedere blocks will vary with installation pattern.

**Curved Freestanding Walls:**

Curved freestanding walls can also be built. Typically, the blocks have to be field adjusted to make the desired curve. Front and back faces will alternate and blocks trimmed as needed to provide a tight fit between blocks with no gaps on either side of the freestanding wall.

**PLANTER / TREE RING**

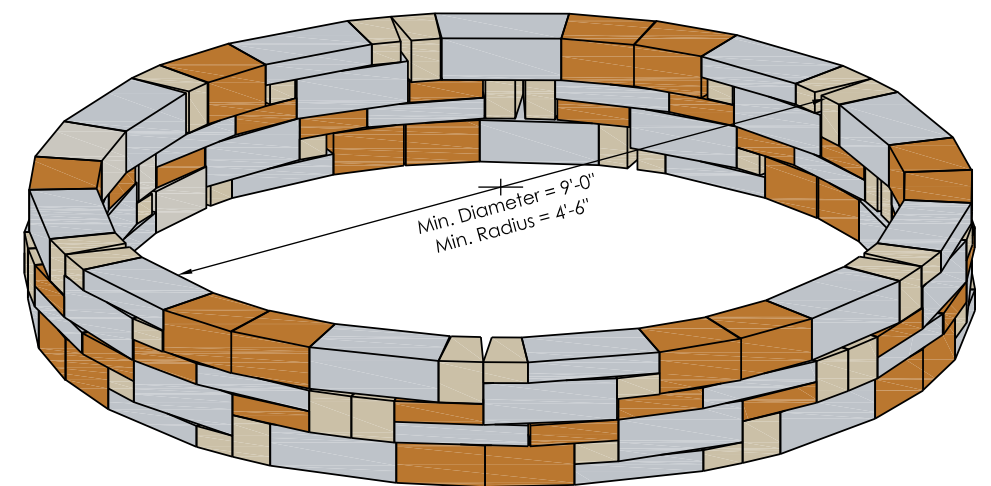

Note: Walls are shown without batter for clarity. Blocks in a retaining wall should be adjusted slightly in place and trimmed as needed to allow wall construction with proper batter.

**PILLAR CONSTRUCTION DETAILS**

This page shows typical construction details for Belvedere pillars. Pillars make nice ends to Freestanding walls, formal stair openings, stand-alone monuments, and other areas to enhance your Belvedere project. The basic steps of pillar construction are shown here. Feel free to expand on these ideas and bring your own creativity into creating a custom project.

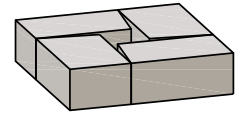

**Step 1**

Place (4) 3" or 6" high corner blocks with the taper facing into the center of the pillar.

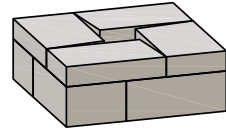

**Step 2**

Place the second row of (4) of the corner blocks with the taper facing into the center of the pillar. Typically if the first row is built with 6" corner blocks, the second row is built with 3" corner blocks.

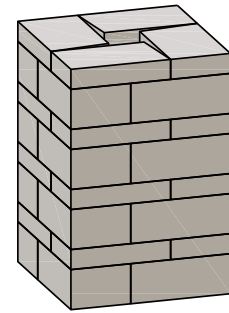

**Step 3**

Continue with subsequent rows to the desired pillar height. One pallet of corner blocks will make a 24" x 24" x 36" high column.

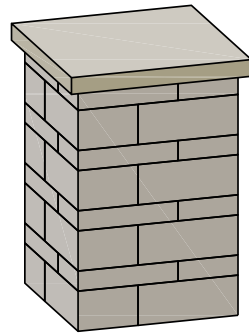

**Step 4**

Place a column cap to finish the pillar. The column cap can be cored as needed for installation of a light.

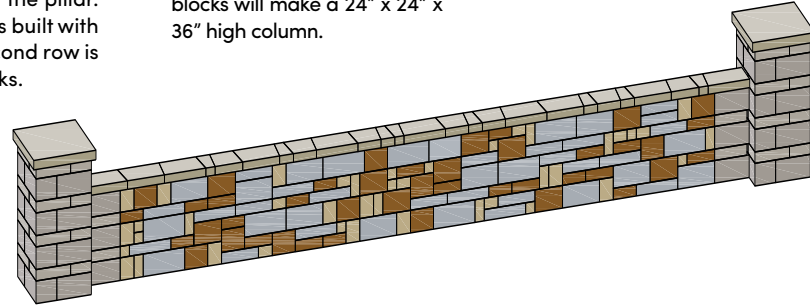

This example shows a freestanding wall with pillars on each end. The wall can either be constructed flush with the pillars, or blocks trimmed to interlock the end of the wall with the pillar.

**CORNERS**

**OUTSIDE CORNER**

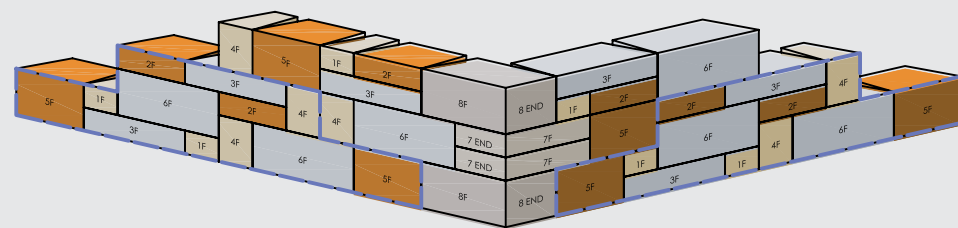

**INSIDE CORNER**

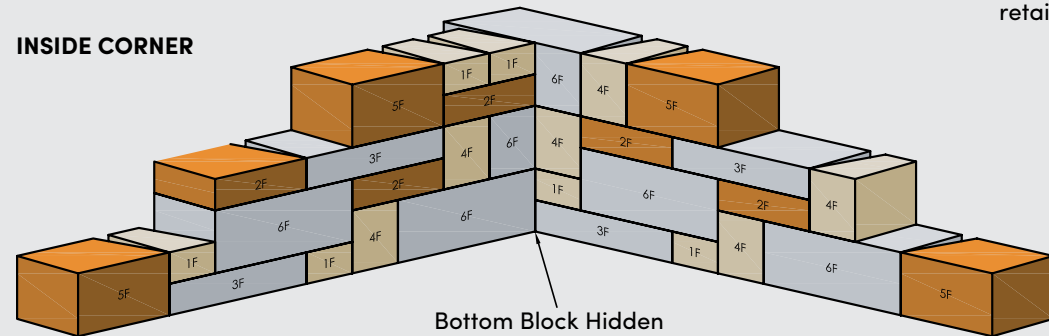

Bottom Block Hidden (see Interlocking Corner Detail)

Note: Wall are shown without batter for clarity. Blocks in a retaining wall should be adjusted slightly in place and trimmed as needed to allow wall construction with proper batter.

**CORNER CONSTRUCTION DETAILS**

This page shows typical construction details for making 90° corner with Belvedere Blocks. Some basic concepts are shown here. Plan to take some time to properly work corners into the larger retaining and freestanding wall patterns.

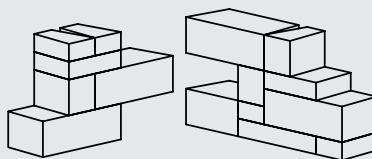

**Interlocking Corner**

Place block in an overlapping, interlocking pattern at corner for added wall stability.

**RETAINING WALL PATTERNS**

**12" High Wall** 12" High x 13'-6" Wall Section Shown = 13.5 sqft (1/2 Wall Pallet)

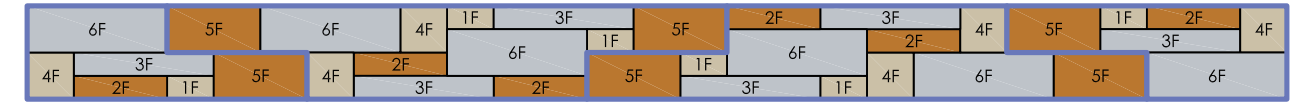

**18" High Wall** 18" High x 18'-0" Wall Section Shown = 27.0 sqft (1 Wall Pallet)

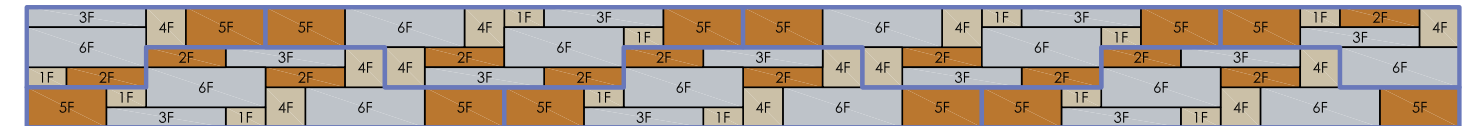

**24" High Wall** 24" High x 16'-0" Wall Section Shown = 32 sqft (Approx. 1.2 Wall Pallet)

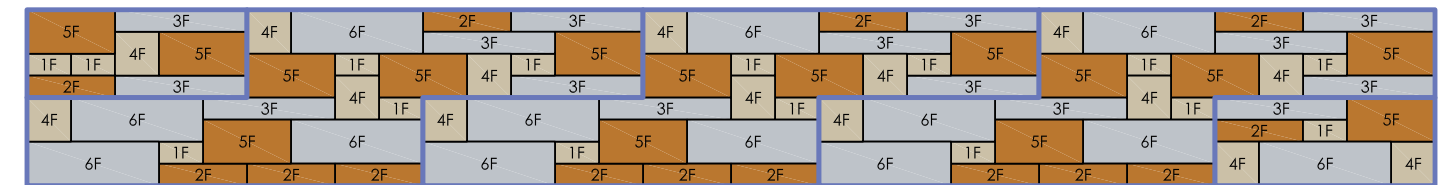

**NOTES:** Retaining walls are typically constructed with the front face of the block exposed. The v-shaped notches which appear on the back of wall between adjacent blocks must be filled with drainstone. The blocks shown above are labeled, for example, 4F would indicate the front (or longer) face of block 4, and 2B would indicate the back (or shorter) face of block 2.

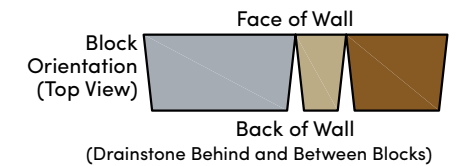

\*These patterns are NOT required and are presented for reference only. They are most useful for long, straight retaining walls.

**FREESTANDING WALL PATTERNS**

**24" Pattern A** Wall Section Shown = 24.67 sqft (Approx. 1 Wall Pallet)

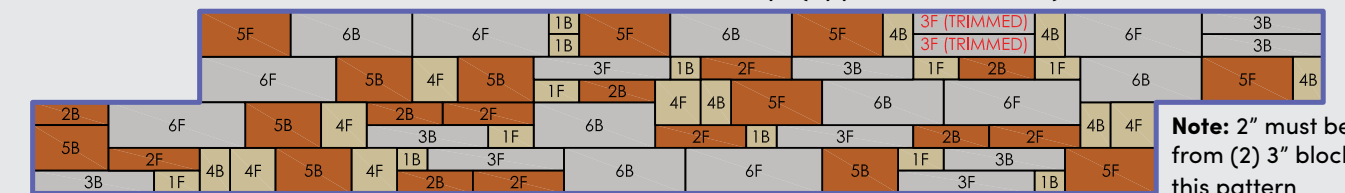

Note: 2" must be trimmed from (2) 3" blocks to make this pattern

**24" Pattern B** Wall Section Shown = 24.67 sqft (Approx. 1 Wall Pallet)

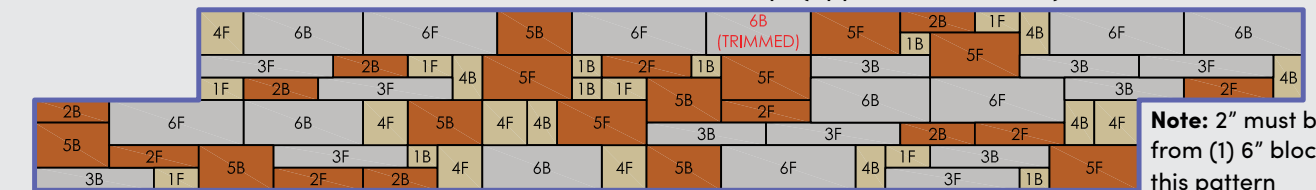

Note: 2" must be trimmed from (1) 6" blocks to make this pattern

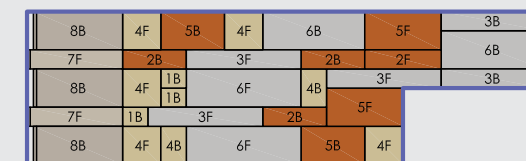

**24" High Vertical End - Left**  
Wall section Shown = 11.67 sqft (1/2 Wall Pallet)  
Note: Vertical End Jogs in and out approximately 1" between blocks

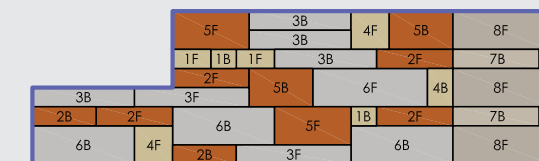

**24" High Vertical End - Right**  
Wall section Shown = 11.67 sqft (1/2 Wall Pallet)  
Note: Vertical End Jogs in and out approximately 1" between blocks

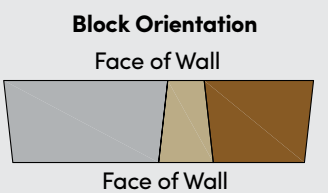

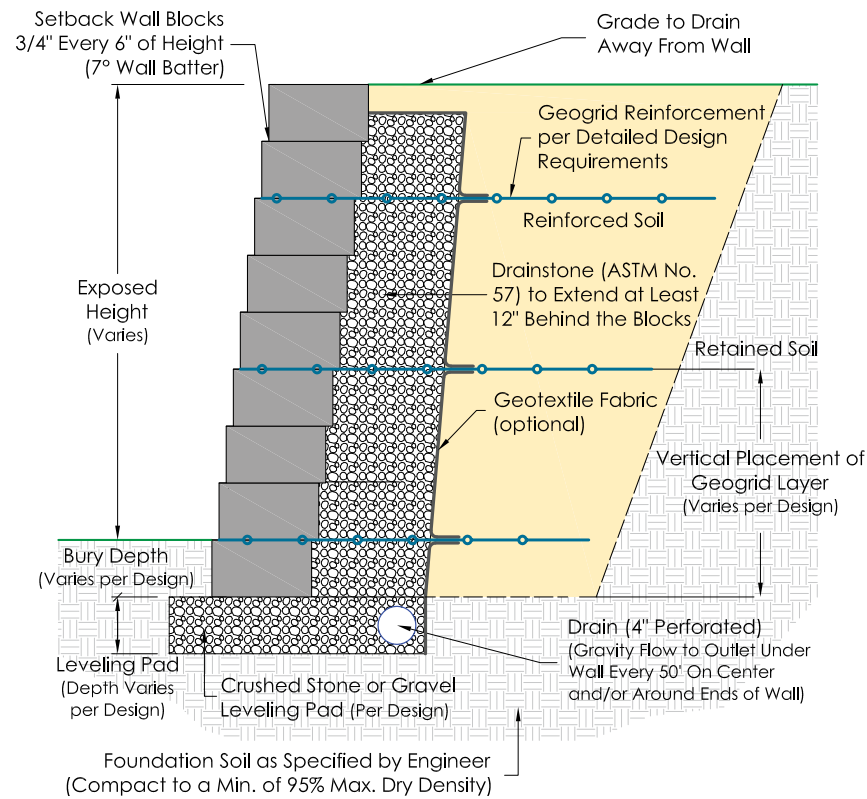

**TYPICAL RETAINING WALL CONSTRUCTION DETAILS**

This page shows typical construction details for Kodah retaining walls. These drawings are representative of major components required in wall construction. Specific details including geotextile reinforcement layers, drainage details, soil requirements, etc. shall be per engineered design for wall.

- This drawing is for reference only
- Final design for construction must be prepared by a registered Professional Engineer using the actual conditions of the proposed site.
- Final wall design must address both internal and external drainage and shall be evaluated by the Professional Engineer who is responsible for the wall design

**CURVED WALL DETAILS**

The taper sides of Kodah blocks allow for construction of a wide range of curves in both retaining and freestanding walls.

1. Minimum radius curves are shown which can be constructed without saw-cutting a significant number of blocks. Larger radius curves can be created by leaving a larger gap between blocks on the back side of the wall. The gaps must be filled with drainstone.
2. When retaining walls are constructed with batter, the radius on outside curves become smaller with each course due to the block setback. For proper construction, the radius of the bottom course must be larger than the minimum radius so upper courses will have sufficient room for construction.
3. When retaining walls are constructed with batter, the radius on inside curves becomes larger with each course due to the block setback.

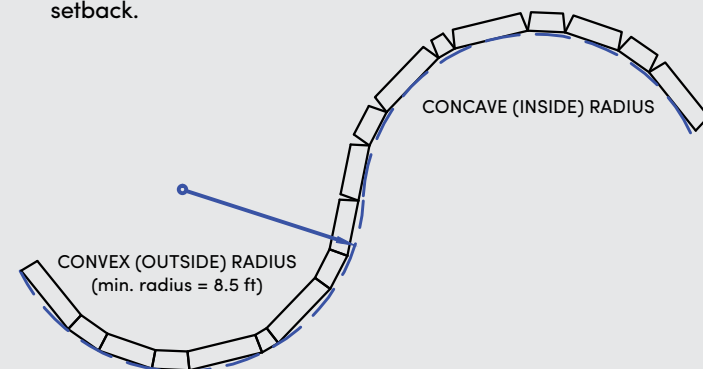

**PILLAR CONSTRUCTION DETAILS**

Kodah pillars can be constructed utilizing 1 full pallet of Kodah Corner Blocks. A 34" Column Cap can be utilized to finish the pillar. The column cap can be cored as needed to accommodate the installation of a lamp.

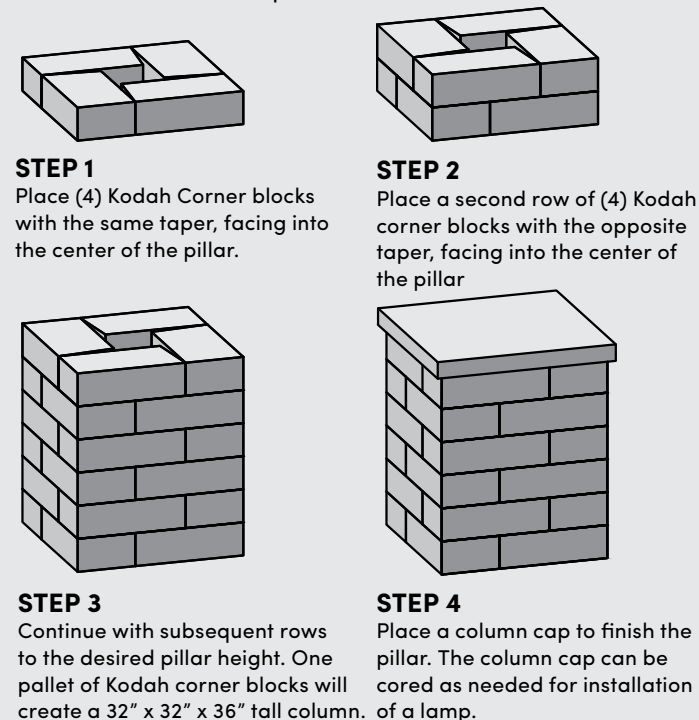

**FLAGSTONE AND PAVER INSTALLATION GUIDE**

Thank you for your interest in installing Rosetta paving products. You will find that these products truly combine the look of natural stone with the efficiency and consistency of concrete pavers. The following guide lays out proper installation techniques for Rosetta Grand, Dimensional, and Flagstone slabs as well as for Mission and Amaro Pavers. For optimal color blending install products from several different pallets simultaneously.

**1. SAFETY**

Make safety your top priority when installing Rosetta paving products. Before starting your project, be sure to address the following points:

- Contact your local utility marking service prior to making any excavation. Be sure to follow all governmental safety regulations.
- Always wear the appropriate personal protective equipment (PPE) including gloves, steel toed boots, safety glasses, hearing protection, respiratory protection, and any other needed safety gear.
- Flagstone slabs are heavy. Follow proper lifting techniques to avoid back injury. Also, use two people to set larger pieces.

**2. PROJECT PLANNING**

The first step in installing Rosetta paving products is to plan your project. Paver layout and placement is important to insure a functional and good looking installation. Remember, Rosetta flagstone products are suitable for pedestrian loading only (patios, walkways, etc.) and will not support the load of a vehicle. Mission Pavers are suitable for vehicular loading.

**3. EXCAVATION AND BASE PREPARATION**

Once you are ready to start construction, you will need to lay out the project area. Mark out the area of the installation with marking paint. Mark a second line 12" (305 mm) outside of the first line that indicates the area to be excavated. This over-excavation will allow for proper base installation.

Excavate to the required depth and grade for the installation of the specific Rosetta paving product you are installing (see cross sections for minimum recommended excavation depths). Once the excavation depth has been established, compact the sub-grade well using a plate tamper. At this point, Rosetta Hardscapes recommends laying a woven geotextile down before applying any granular base materials.

**PERMEABLE INSTALLATIONS:** Unless specified, avoid compaction of existing sub-grade soils if installing a permeable pavement.

**4. PLACE THE COMPACTED GRAVEL BASE**

For standard paver and flagstone installations, begin by spreading half of granular base material in the excavation. (Note: Lifts should not exceed 6" (150 mm) in thickness.) Compact this first lift to 98% standard proctor using a plate tamper and adding water as needed. Add the second lift of granular material and compact in the same manner as the first. For permeable paver installations, install open-graded sub-base and base course material as specified in the project drawings.

**KEY POINT:** When installing granular base materials, be sure to consider proper grades to prevent water from standing on the surface and make sure water is directed away from building structures.

**5. PAVER INSTALLATION**

Bedding material requirements and paver installation vary by product type. Please see the following product specific installation instructions and tips for more details on paver installation.

**For the most natural appearance, install products from multiple pallets simultaneously. This will create a more blended, natural look.**

**GRAND FLAGSTONE INSTALLATION**

**BEDDING SAND INSTALLATION:** Using screed rails on the compacted granular base, apply bedding sand at a maximum thickness of 1" (25mm). By using a screed board along the top of the screed rails, the bedding sand will level evenly. Bedding sand should be compacted since Grand Flagstone slabs should not be compacted after installation.

**FLAGSTONE INSTALLATION:**

- Begin by laying the individual pieces of Grand Flagstone on the screeded bedding material according to your detailed project plan.
- Separate individual pieces approximately 3/8" (10 mm) from each other. When units are set with a 3/8" gap, a full pallet will produce 90 square feet (8.36 m2) of coverage.
- Cut units as needed to finish edges.
- *NOTE: To ensure proper color distribution, mix layers from several bundles at one time.*

**JOINT SAND INSTALLATION:** Once the flagstone pieces are installed, fill all joints with jointing sand suitable for large joints. Sweep the sand into the joints between flagstones until the joints are completely filled. Follow the jointing sand manufacturer's recommendations for wetting the sand. You may need to repeat this process with more dry sand in a few days to completely fill the joints between individual slabs.

**CAUTION:** Grand Flagstone slabs should not be compacted after installation.

**OTHER CONSIDERATIONS:**

**SEALING:** You may want to apply a sealer to protect the flagstone slabs from spills and stains. Always use a high quality sealer specifically formulated for wet-cast concrete.

*Not suitable for vehicular traffic*

**TYPICAL CROSS-SECTION**

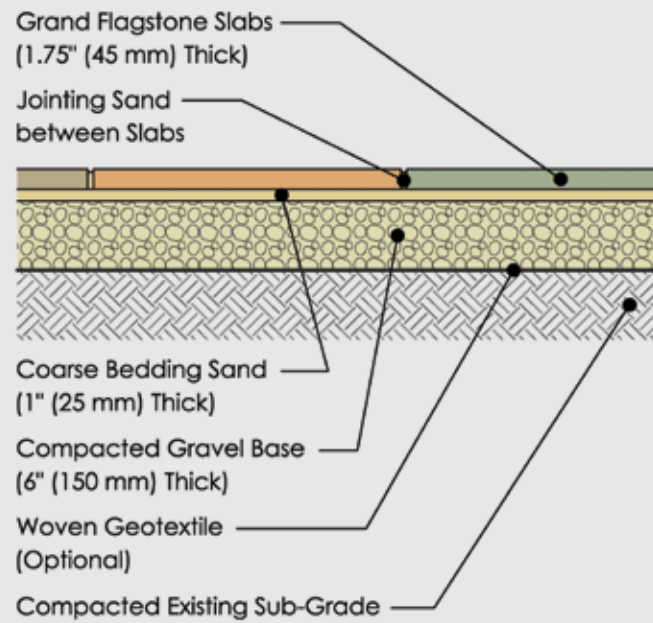

**STRAIGHT WALKWAY INSTALLATION**

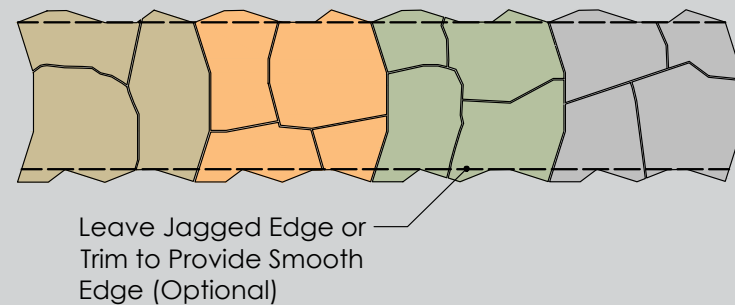

**PLACING GRAND FLAGSTONE**

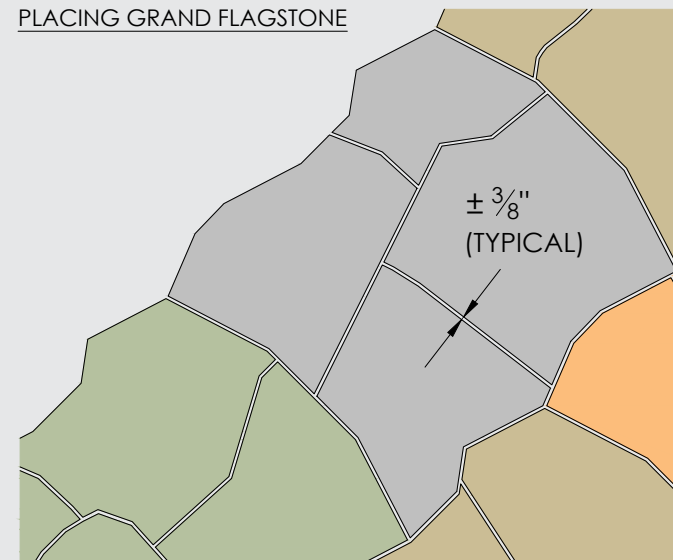

**INTERLOCKING LAYERS:**

Grand Flagstone has been designed so each layer of slabs on a pallet is an interlocking set. Each interlocking set, or layer, of slabs has been designed to interlock with all other layers.

**COMMON POINTS FOR INTERLOCKING LAYERS**

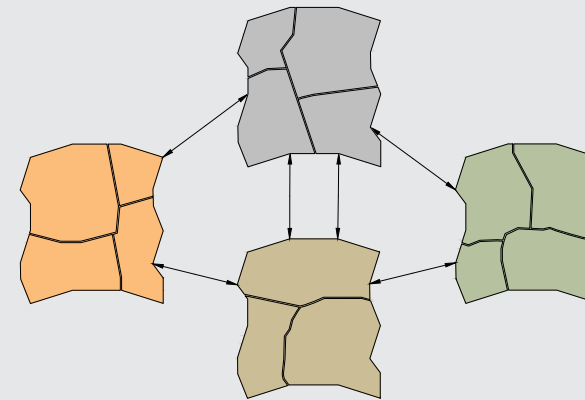

**PROPERLY PLACED INTERLOCKING LAYERS**

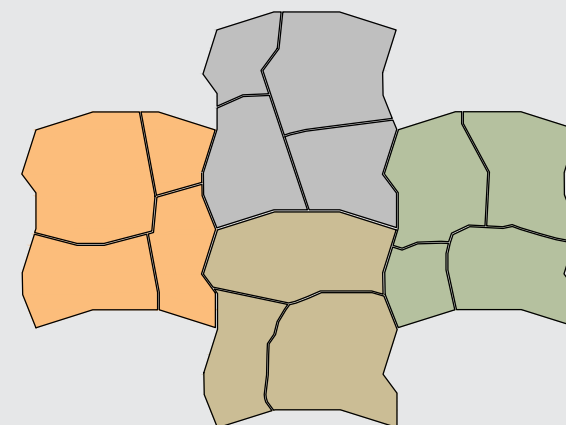

**LAYOUT ORIENTATION:**

Layout orientation is important with Grand Flagstone. Due to the nature of the interlocking sets of slabs, there are long, unbroken joints between rows. Often, the irregular nature of the Grand Flagstone limits how noticeable these unbroken joints are in the finished project. However, the lines become slightly more noticeable when you are looking parallel to the unbroken joints than when you are looking at them on an angle. To limit this effect, Grand Flagstone layers should be laid at a 45 degree angle from the most common viewing angle. This viewing angle would most likely be a patio entrance or step location.

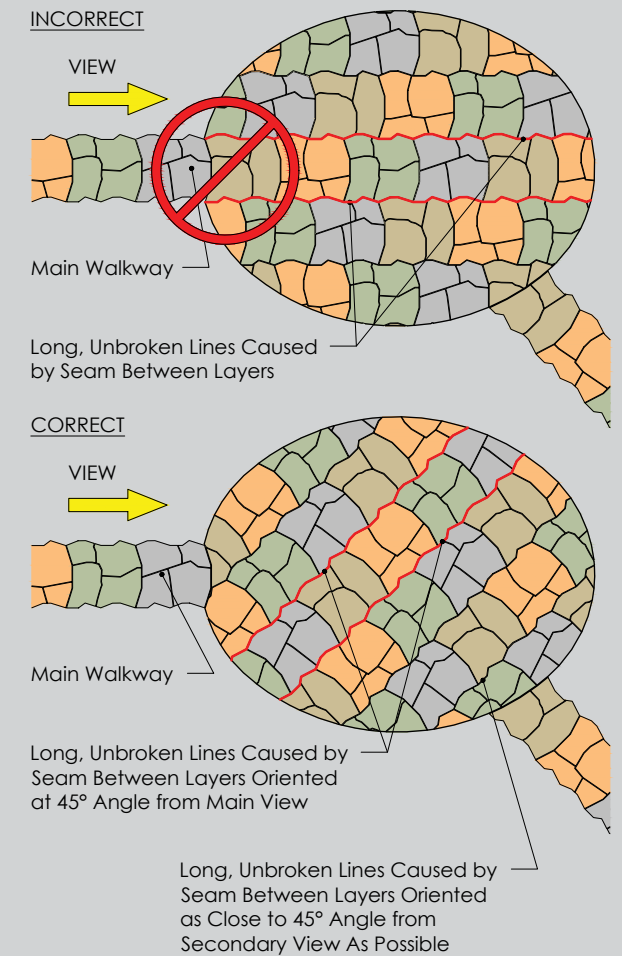

**PROCEDURE FOR INSTALLING CRACKED PIECES:**

Individual pieces of Grand Flagstone can crack either during delivery to the job or during on-site handling prior to placement. Typically less than 5% of the pieces will crack. There are two methods to deal with cracked pieces.

The first method is to use the cracked pieces to fill in around the edge of the project where there is always a need for small pieces.

The second method is to use the cracked pieces to enhance the layout pattern. Since Grand Flagstone is designed to create an irregular flagstone walking surface, an extra crack simply provides another joint line in the Grand Flagstone pattern. Place the cracked pieces next to each other with a 3/8" (10 mm) joint between them. The joint is filled with polymeric jointing sand just like all the other joints. If necessary, the cracked pieces may need to be trimmed to create a smoother edge or provide a larger joint to match all the other joints in your project.

**INSTALLING CRACKED PIECES**

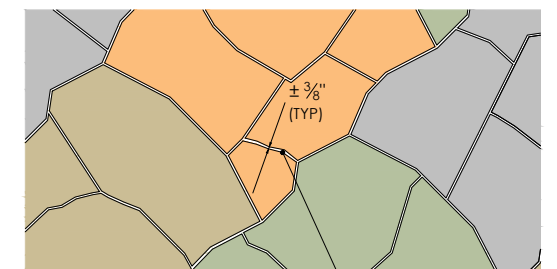

- Trim Broken Edges if needed
- Install Pieces with Typical 3/8" (10 mm) Joint

**DIMENSIONAL FLAGSTONE INSTALLATION**

**BEDDING SAND INSTALLATION:** Using screed rails on the compacted granular base, apply bedding sand at a maximum thickness of 1" (25mm). By using a screed board along the top of the screed rails, the bedding sand will level evenly. Bedding sand should be compacted since Dimensional Flagstone slabs should not be compacted after installation.

**FLAGSTONE INSTALLATION:**

- Begin by laying the individual pieces of Dimensional Flagstone on the screeded bedding material according to your detailed project plan.
- Push flagstone slabs directly together so the bottom edges butt tight. There is no need to space the slabs to create the necessary joint. Joint is pre-set in the unit
- Cut units as needed to finish edges of installation.
- *NOTE: To ensure proper color distribution, mix layers from several bundles at one time.*

**JOINT SAND INSTALLATION:** Once the flagstone pieces are installed, fill all joints with jointing sand suitable for large joints. Sweep the sand into the joints between flagstones until the joints are completely filled. Follow the jointing sand manufacturer's recommendations for wetting the sand. You may need to repeat this process with more dry sand in a few days to completely fill the joints between individual slabs.

*CAUTION: Dimensional Flagstone slabs should not be compacted after installation.*

**OTHER CONSIDERATIONS:** You may want to apply a sealer to protect the flagstone slabs from spills and stains. Always use a high quality sealer specifically formulated for wet-cast concrete.

*Not suitable for vehicular traffic*

**DIMENSIONAL FLAGSTONE CROSS-SECTION**

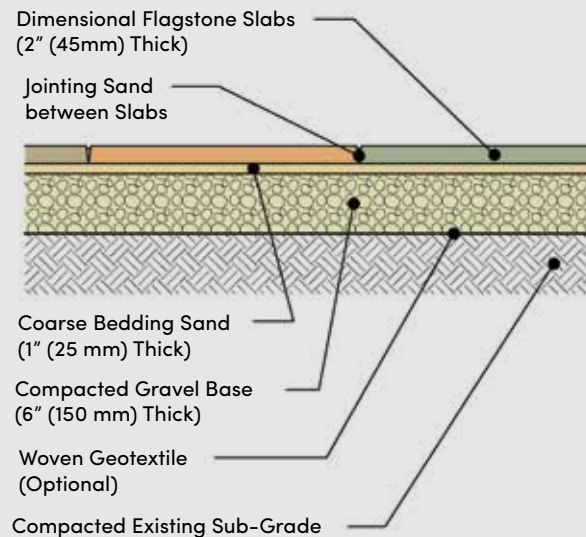

**WALKWAY LAYOUT**

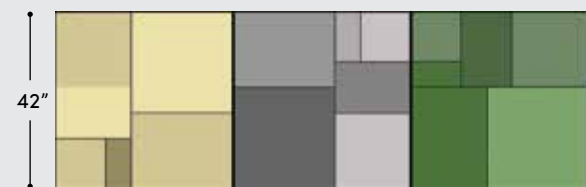

**PATIO LAYOUT**

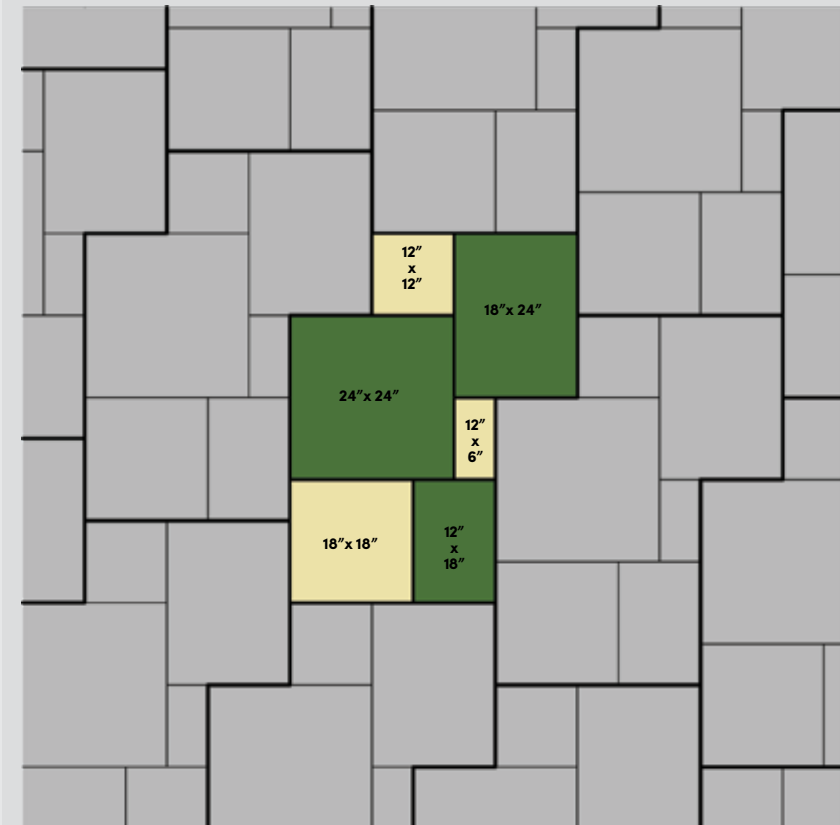

**MISSION PAVER & AMARO INSTALLATION**

The following guidelines are based on minimum recommendations from the ICPI (Interlocking Concrete Pavement Institute). For an in-depth overview of the design and installation of interlocking concrete pavements and permeable pavements, please visit their website at icpi.org. Paver cross-sections and details shown are based on pedestrian or residential drive loadings with normal site conditions. Foundation, gravel base, and drainage details will need to be addressed if poor soil conditions or commercial or industrial vehicular loadings will be present.

**INSTALLATION OF EDGE RESTRAINT:** Before installing pavers or bedding material, ensure proper paver edge restraint has been installed. Edge restraint should consist of a precast or cast-in-place concrete curb. For pedestrian loads or residential drives, plastic or metal edging strips fastened to the compacted base below with metal spikes are an acceptable alternative.

**BEDDING MATERIAL INSTALLATION:** For standard paver installation (non-permeable applications), apply bedding sand at a maximum thickness of 1" (25mm) on top of the compacted granular base. Level bedding sand evenly by using a screed board along the top of the screed rails. Do not bed pavers in sand for permeable paver installations. Instead, bed pavers in 2" (50 mm) of ASTM #8 aggregate.

**PAVER INSTALLATION:**

- Begin by laying the individual pavers on screeded bedding material according to your detailed project plan.
- Push pavers together so the spacer bars butt tight and cut units as needed to finish edges.

**TYPICAL PAVER CROSS-SECTION**

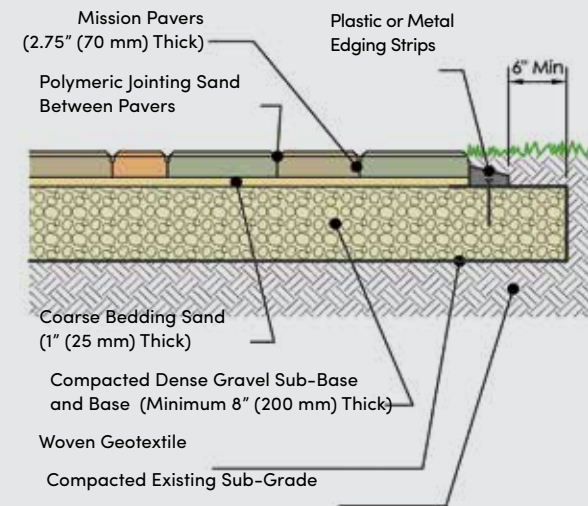

*Note: Section shown are minimum recommendations for residential drivers and pedestrian loading. Commercial projects with vehicular traffic or sites with poor soil conditions may require thicker gravel base and concrete curb edge restraints.*

- To ensure proper color distribution, mix layers from several bundles at one time.
- Once installed, set pavers in bedding material by compacting with a plate compactor. Compaction should proceed in overlapping rows such that each area is crossed at least twice by the compactor in two perpendicular directions. Note that pavements should be filled and compacted to within six feet of the laying surface at the end of each work day.
- **KEY POINT:** Pavers will settle slightly (1/4" - 3/8") during compaction. Final grade of base and bedding material should be adjusted to account for this settlement. Take special care where pavers abut existing site features such as other pavements.

*CAUTION: A urethane pad must be used with the plate compactor to avoid damage to pavers.*

**JOINT SAND INSTALLATION:** Fill all joints with jointing sand for standard paver installations or appropriate aggregate for permeable installations. Sweep joint filler material into the joints between pavers until the joints are completely filled. After the joints are filled, carefully sweep pavers clean before compacting. Loose joint material could damage the surface of the pavers during compaction. Top off joints if joint material settles during compaction and re-compact if necessary.

**OTHER CONSIDERATIONS:** You may want to apply a sealer to protect the pavers from spills and stains. Always use a high quality sealer specifically formulated for wet-cast concrete.

*When snowplowing Mission Pavers, a poly cutting edge must be used to avoid marking the surface of the pavers.*

**TYPICAL PERMEABLE CROSS-SECTION**

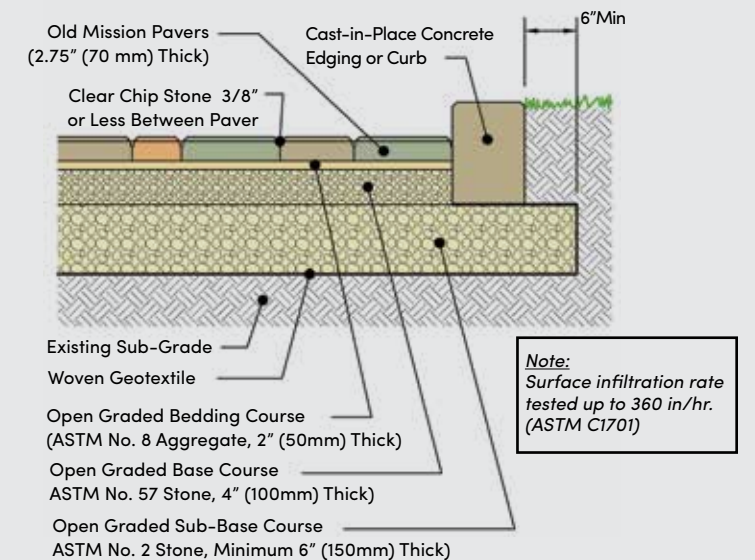

*Note: Surface infiltration rate tested up to 360 in/hr. (ASTM C1701)*

*Note: Section shown is based on minimum ICPI recommendations. Sub-base and base thicknesses, edge restraint, and drainage details vary depending on job requirements. Please see the project drawings.*

**Begin the step installation process** by measuring the total rise required and calculating the number of steps to be used. Each step has a 5 1/2" or 7" rise, but should be sloped approximately 1/2" such that the back of the step is higher than the front of the step. This slope will facilitate surface water drainage. With appropriate sloping, the net rise of each step is 6" or 7 1/2". Divide the total rise by 6" or 7 1/2" to get the number of steps required.

Next, **calculate the tread width**. Generally, when the grade allows, a 12" or wider tread is desirable. To calculate the tread width, divide the total allowable horizontal run minus the width of the top step, by the number of steps minus one. The one less will account for the top step.

**Consider the following example:**

Total rise = 42", Total horizontal run = 108", Width of top step = 24", Rise of steps = 5 1/2",  
Number of steps = 42" ÷ 6"/Step = 7 Steps  
Tread Depth = (108" - 24") ÷ (7-1) = 14" Tread Depth

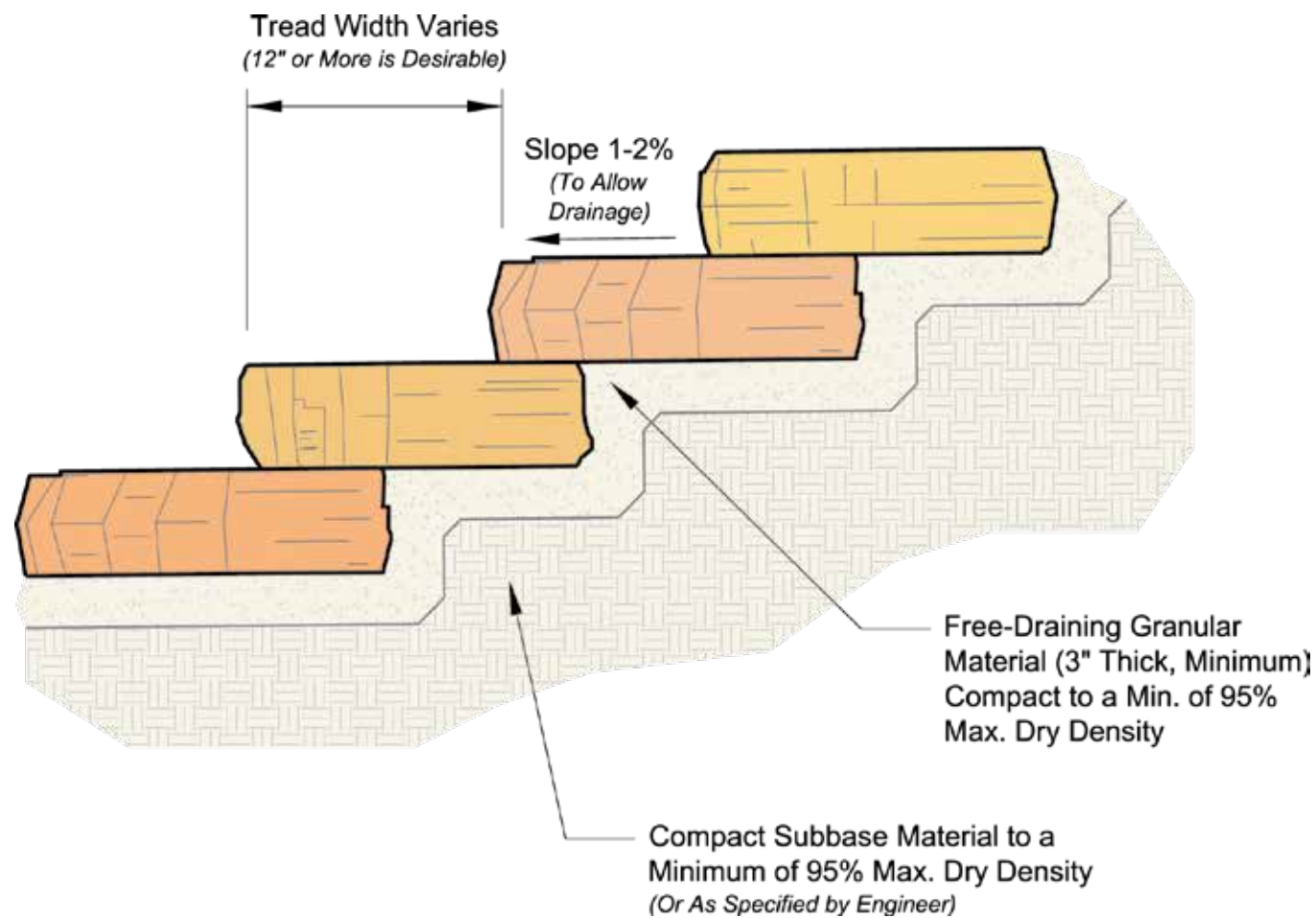

**Excavate and grade the area for the first step.** Steps should be placed on at least 3" of free draining soil, such as sand or pea-stone. Compact soil to a minimum of 95% Standard Proctor.

**Place step** with either forks or straps using a small excavator or skid-steer to lift the piece into place. Practice safe handling procedures during this process.

**Fill behind each step** with free draining soil and compact to 95% standard proctor. Remember to slope fill to allow for proper drainage when next step is placed. Continue placing steps in this manner until finish grade is reached.

- This drawing is for reference only.
- Block size and placement shown are for reference only. Individual steps will vary with installation pattern.



## Wow Your Customers with Pre-Planned Patio Designs

With Rosetta's pre-planned patio designs, you can give your customers exactly what they want--the beautiful look of natural stone--without adding extra design and estimating time on your end. Each pre-planned patio design comes with multiple upgrade options, and you can further customize the projects with any of the Rosetta Hardscapes products.



To simplify your workflow and wow your customers visit [RosettaHardscapes.com/PatioDesigns](https://RosettaHardscapes.com/PatioDesigns) just follow these three steps!



Show your customers the Pre-Planned Patio Brochure to expedite their design choice

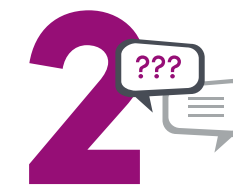

Use the expense templates in the Pre-Planned Patio Design Guide to order exactly the amount of product you'll need from your local dealer



Install patio following the step-by-step instructions in the Tech Guide and wow your customer with the results!

