



 **Atlantic**® | *Oase*®
2020

WELCOME TO THE FUTURE OF WATER FEATURES

By now you may have heard that there's a lot going on here at Atlantic. The world's largest water feature equipment company, OASE joined forces with us in October 2018. Thorsten Muck, CEO of OASE, called it the ideal marriage, American contractor-centric products and philosophy with European engineered filtration and fountain innovation. We think you'll agree. Let's talk first about the coming changes.

Our new warehouse in Aurora, Ohio is a big change, literally, at 170,000 square feet. Besides a bigger showroom area with space for all the samples, offices and conference rooms galore, cafe and picnic areas, video conferencing and presentation rooms, we'll also have space for the SandBox, an indoor hands-on installation area for all-season training. Best of all, we have the room for a world class warehouse with all Atlantic and OASE products under one roof, utilizing the most up-to-date shipping and receiving technology available.

We have already added and will be continuing to add more people to work in; customer service & inside sales; training; accounting; and shipping. Our sales teams are combining to bring you a wealth of experience and decades of industry knowledge.

The 2020 Catalog reflects the melding of product lines. Along with the re-engineered Atlantic Lighting line and more Fountain and Formal Spillway products than ever before, you'll find OASE products presented in the format you've become accustomed to:

- Water Entertainment products like the Trio, Quintet and Water Jet Lightning, to delight all ages
- Advanced Water Garden filtration from all-in-one units for small ponds to modular, computer controlled ProfiClear filters that literally clean themselves
- PondoVac pond vacuums, tools and accessories to make water feature maintenance faster and easier
- Ultra-efficient brushless DC pumps that handle hard, chlorinated and saltwater with ease
- A suite of cloud-based Electronic Garden Control products that bring new meaning to the term "Next Generation"

Best of all, OASE products work in concert with Atlantic's, complementing the products you already know, use and love. All these changes additions and improvements to the way we do business have been implemented and continue to be as we move into the 2020 season. The new SAP system that will better track and deliver your purchases is up and running. We have already moved our operations to the new warehouse. New and existing personnel started working there in December 2019 and we will be servicing your combined Atlantic-OASE orders by January.

Our service, attitude and company culture will remain the same. Your contact points, both in the sales field and at our new headquarters, will be the same people you have long been familiar with along with some new faces who are being trained and encouraged to provide you with the exemplary service you can expect from a company of our size and standing. We're proud and excited to be part of a company that, like us, is 'Passionate about Water'. We think you will be too.

Here's to a successful 2020!

Jeff Weemhoff, President, & the Atlantic-OASE Team



Atlantic-OASE's new 170,000 square foot headquarters

TABLE OF CONTENTS

| | | |
|-----|----------------|---|
| 6 | F | FOUNTAIN FOUNTAIN BASINS / ACCESSORIES / FLEXIBLE BASINS / ECO-RISE / BASALT COLUMNS / COLOR CHANGING VASES / COPPER FOUNTAIN BOWLS / NOZZLES / WATER TRIO & QUINTET / WATER JET LIGHTNING |
| 22 | FS | FORMAL SPILLWAY BASIN KITS / BASINS / FLEXIBLE BASINS / COPPER SPILLWAY BOWLS / WALL SPOUTS / COLORFALLS / COLOR CHANGING COLORFALLS / SPILLWAYS / WATERWALLS / SPLASH RINGS |
| 36 | PF | POND-FREE ECO-BLOX / POND-FREE KITS / PUMP VAULTS/ FASTFALLS |
| 44 | WG | WATER GARDEN SKIMMERS / FILTERFALLS / WATER GARDEN KITS / ACCESSORIES / COMPLETE FILTER KITS / IN-POND SKIMMERS / BIOPRESS / FILTOCLEAR / BIOSMART / BIOTEC SCREENMATIC2 / PROFICLEAR / VITRONIC / BITRON C |
| 68 | P | PUMP FP-SERIES / MD-SERIES / TT-SERIES / PAF-SERIES / SH-SERIES / A-SERIES / L-SERIES / TIDALWAVE ACCESSORIES / FOUNTAIN / NEPTUN / AQUARIUS ECO EXPERT / AQUAMAX ECO CLASSIC-PREMIUM-EXPERT / WATERFALL / OASE ACCESSORIES |
| 90 | I | INSTALLATION CHECK VALVES / INSTALLATION PRODUCTS / EPDM LINER / FITTINGS & TUBING |
| 98 | L | LIGHTING SPOTLIGHTS / HARDSCAPE LIGHTS / FOUNTAIN LIGHTING / SPECIALTY LIGHTING / POND LIGHTING / WIRING / SMART MODULE / WIRING KITS / TRANSFORMERS / LUNAQUA & ACCESSORIES / PROFILUX LIGHTING & ACCESSORIES |
| 111 | M | MAINTENANCE IONIZER / TREATMENTS / POND DE-ICER / AIR PUMPS / AQUAOXY / OXYTEX / ICE-FREE 4 SEASONS / TOOLS & ACCESSORIES / PONDOVACS / NETTING |
| 128 | P&L | POND & LAKE DIFFUSERS / COMPRESSORS / TUBING / TREATMENTS / SHALLOW WATER SYSTEMS / DEEP WATER SYSTEMS / FLOATING FOUNTAINS |
| 140 | RH | RAIN HARVESTING CLEAN RAIN ULTRA / PUMPS / PUMP VAULT / RAIN HARVESTING KITS / RAIN HARVESTING ACCESSORIES |
| 146 | TD | TECHNICAL DATA & POP |

 Products proudly manufactured in the United States

 Products proudly manufactured in Germany

 Video available through our website

 Eco-friendly product with outstanding energy balance

 CAD drawing available through our website

 3D model available on our website

 Easy Garden Control (EGC) product

 Clear Water Guarantee (CWG) product

Atlantic SMART PRODUCTS

All Apps are available for free on both Apple and Android devices on the App Store and Google Play.



INFICOLOR APP FOR COLOR CHANGING LIGHTING & COLORFALLS



Color Changing Lighting on Pages 98-107

The Inficolor mobile application unlocks a world of custom colors, sequences and transitions and sets sequence timing and daily scheduling on any Apple or Android mobile device. Best of all, the Inficolor App eliminates the need for a separate remote control.

- Select any or all of the three zones to control
- Choose any color with color picker or RGB sliders
- Create and save custom color sequences as Favorites
- Assign one of five transitions and adjust the speed of any Favorite
- Adjust brightness of sequences and solid colors if desired
- The three zones can be independently named and scheduled
- Inficolor App available on all Apple or Android devices

TIDALWAVE VSC APP FOR VARIABLE SPEED CONTROLLER



TidalWave Variable Speed Controller on Page 78

- All TidalWave Variable Speed Controllers are compatible with the TidalWave VSC app
- Turns TT pumps on and off and controls pump output
- Customize network name and password for secure access
- Effortlessly switch between multiple VSCs in Wi-Fi settings to control different water features
- Available for both Android and Apple smartphones and tablets

IONIZER APP FOR TRITON IONIZER



Triton Ionizer on Page 112

- The Triton Ionizer app allows you to adjust the level of ionization and turn the power on/off
- Conductivity alert will inform you if your water is not conductive enough for selected ionization level
- Customize network name and password for secure access
- Effortlessly switch between multiple Ionizers in Wi-Fi settings to control different water features
- Available for both Android and Apple smartphones and tablets

Oase SMART PRODUCTS

EASY GARDEN CONTROL (EGC)

The EGC Cloud Controller is the heart of the OASE Easy Garden Control (EGC) system. It enables the control of up to 10 EGC devices with Apple or Android phone or tablet from your router connection or from the OASE Cloud. Complete control of your EGC system can be done from anywhere in the world when connected to the OASE Cloud. An integrated WiFi antenna connection technology lets you easily, conveniently and quickly read and regulate the information of your garden devices via smartphone or tablet.

- Connect devices via WiFi from up to 260' to the Controller
- Controller mounts conveniently on a wall or in the ground with included stake and mounting hardware
- The controller housing has an IP64 waterproof rating allowing for all-season outdoor use
- All compatible devices connect to each other by cables to in/out plugs on devices
- All individual components are individually controlled regardless of their location in the chain of devices
- Includes 6' EGC connection cable, 6' power cable, end resistor and 110V outdoor transformer



Compatible Devices:

- ProfiClear Premium Filters Compact-M & Compact-L (Page 64)
- Aquarius Eco Expert Pump (Page 82)
- Aquamax Eco Expert Pump (Page 86)
- ProfiLux LED RGB Lights (Page 110)

| ITEM | LIST | DESCRIPTION | INPUT | WATTS | CORD | DIMENSIONS | WARRANTY |
|-------|----------|----------------------|------------|-------|------|--------------------|----------|
| 72380 | \$283.99 | EGC Cloud Controller | 12 volt AC | 4 | 6' | 5¼"W x 3½"D x 1½"H | 3-year |

EASY GARDEN CONTROL (EGC) ACCESSORIES

- Connection Cables are special cables for bi-directional communication between EGC devices
- Cable Connector EGC with plug on one side and socket on the other allows watertight connect of 2 EGC cables
- 4-wire shielded Cable and Connector plug-and-socket connections are completely waterproof for underwater use

| ITEM | LIST | DESCRIPTION | CORD | WARRANTY |
|-------|---------|----------------------|------|----------|
| 72381 | \$39.99 | Connection Cable EGC | 8' | 2-year |
| 72383 | \$50.99 | Connection Cable EGC | 16' | 2-year |
| 72384 | \$79.99 | Connection Cable EGC | 32' | 2-year |
| 72385 | \$10.99 | Cable Connector EGC | --- | 2-year |

EGC Compatible devices connect to each other in series, one after the other using Connection Cables and Connectors. Use an End Resistor at the termination of the series.



F FOUNTAIN

Atlantic's Fountain System is the easiest, fastest and strongest way to build a water feature on or into any horizontal surface. Heavy-duty matched components make setting, plumbing and running your feature simple. Components are designed to work together to beautify any landscape. With systems that will handle any size, any shape and any load, the only limit is your imagination!

- » Systems can be installed in hardscapes or landscapes, in-ground or above-ground, indoors or outdoors for maximum versatility
- » Fountain Basins with integrated internal supports handle more weight with greater stability
- » The Triton 3-Way Diverter makes plumbing and flow control of multiple fountain pieces simple and easy
- » Topside plumbing and tubing channels allow for above water installation and adjustment, no need to get wet
- » Eco-Rise systems with Atlantic's Eco-Blox modular reservoirs support any weight, any size and any number of decorative elements in any configuration
- » OASE Water Entertainment delights the senses with illuminated laminar streams and dancing jets



- 1 Molded as one piece, support cones from the bottom of the basins are fused to the flat top panel, integrating the two planes for exceptional strength.
- 2 Large access door makes pump installation and maintenance easy.
- 3 Complete plumbing kits for decorative items include flow controls and pump connections for FP, MD and TT Pumps.
- 4 The Triton 3-Way Diverter features a 1½" inlet for unrestricted flow to three ¾" outlets. True ball valves with removable handles enable independent flow adjustments to each outlet without moving the decorative gravel.

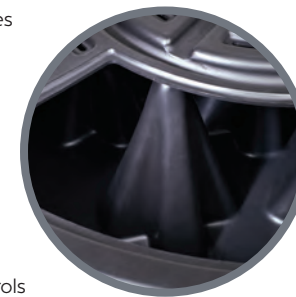

- 5 Built-in channels allow the plumbing to run on top of the basin, simplifying installation and adjustments.
- 6 Recesses allow 1½" conduit to be installed within the radius of the basin, providing easy access to the pump cord and lighting wires when the basin is installed. 1½" cord stoppers are supplied with all Fountain Basin Plumbing Kits.
- 7 The ability to install and access an Auto Fill Valve eliminates the need to manually add water to the system.
- 8 Pair Atlantic Warm White and Color Changing Lighting with Fountain Systems to add dramatic appeal after dark.



FOUNTAIN BASINS



FB2400



FB3200



FB4600

- Fountain Basins provide concealed water storage and support for decorative water features
- Atlantic Fountain Basins are the easiest way to add a water feature to your landscape even for the novice installer
- Quickly installed at, above or below grade in landscapes or hardscapes
- Recessed channels allow fast tubing installation without fear of kinking and crushing, no drilling or modification required
- Topside flow adjustment and easy pump access make maintenance faster and more convenient
- Multiple internal supports handle greater loads with better stability

| MODEL | ITEM | LIST | DIMENSIONS | MAX PUMP FLOW | PLUMBING SIZE | CAPACITY | MAX LOAD | WARRANTY |
|--------|-------|----------|--------------------|---------------|------------------------|------------|------------|----------|
| FB2400 | 74958 | \$167.99 | 24"W x 24"D x 10"H | 750 gph | Up to 3/4" | 20 gallons | 200 lbs. | Lifetime |
| FB3200 | 74962 | \$309.99 | 32"W x 13"H | 2,000 gph | (3) 3/4" or (1) 1" | 32 gallons | 400 lbs. | Lifetime |
| FB4600 | 74967 | \$437.99 | 46"W x 13"H | 4,000 gph | (3) 3/4" or (1) 1 1/2" | 67 gallons | 1,200 lbs. | Lifetime |

FOUNTAIN BASIN FEATURES:

1. One-piece construction provides exceptional strength.
2. Built-in channels simplify installation, allowing the plumbing to be run on top of the basin.
3. Molded cones support the top panel.
4. Recessed pocket accepts Triton 3-Way Diverter (FB4600 only). Adjusting the water flow to multiple pieces has never been easier.
5. 1 1/2" conduit recesses allow for clean installation in surrounding masonry without notching.
6. Flat panel for optional AF1000 Auto Fill installation.



FB4600 shown

FOUNTAIN ACCESSORIES

TRITON 3-WAY DIVERTER

The Triton 3-Way Diverter works with the FB4600 Fountain Basin to provide individual flow control to multiple fountain pieces without having to access the pump inside the pump chamber.

- The 1 1/2" inlet allows unrestricted flow into the manifold
- Ball valves with removable handles enable independent flow adjustment of each outlet
- The compact design makes it a perfect fit for installation in Pump Vaults and Fountain Basins



| MODEL | ITEM | LIST | DIMENSIONS | INLET | OUTLET | "T" HANDLES | WARRANTY |
|--------|-------|---------|-----------------------------|-------------|-----------------|---------------|----------|
| TR3WAY | 73814 | \$23.99 | 5 5/8"L x 4 1/2"W x 2 5/8"H | 1 1/2" FIPT | (3) 3/4" Insert | (2) removable | 1-year |

PLUMBING KITS



FBKIT1



FBKIT3

- Kits include everything needed, from valves to fittings, reducing installation time
- Matching components work with TidalWave Pumps and Fountain Basins to eliminate compatibility concerns
- Single and triple adjustment valves are located above water level, for greater comfort and convenience
- Kits include sealing strips for 3/4" PVC standpipes to eliminate the need to drill large holes for bulkheads in ceramic vases

| MODEL | ITEM | LIST | FOR USE WITH | VALVE | KINK-FREE 3/4" HOSE | STANDPIPE SEALANT | FITTINGS | CORD STOPPER | WARRANTY |
|--------|-------|----------|-------------------------------|-----------------------|---------------------|-------------------|-------------------------------|-------------------------------|----------|
| FBKIT1 | 73812 | \$68.99 | FP200 - 500 & MD250 - 750 | Single | 6' | (1) strip | 3/4" insert x 3/4" socket | 1 1/2" for conduit sleeve | 1-year |
| FBKIT3 | 73813 | \$141.99 | MD1000 - 1500 & TT1500 - 3000 | Triton 3-Way Diverter | 20' | (3) strips | (3) 3/4" insert x 3/4" socket | (2) 1 1/2" for conduit sleeve | 1-year |



FLEXIBLE FOUNTAIN BASINS

ECO-RISE

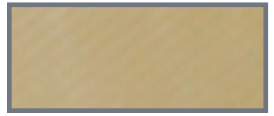
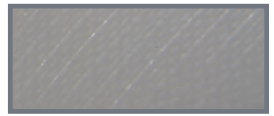

FF4416B
FF4616B
FF4816B
FF4016B
FF6016B
FF8016B

FF4416G
FF4616G
FF4816G
FF4016G
FF6016G
FF8016G

FF4416T
FF4616T
FF4816T
FF4016T
FF6016T
FF8016T

- Flexible Basins instantly create open reservoirs below grade or inside raised walls
- Atlantic's Flexible Fountain Basins are designed to work with most popular manufactured wall stones and colors
- Reinforced PVC construction with fold out flaps and punched glue points anchors liner under capstones for security and durability
- Unlike improvised EPDM liner basins, custom 28mil PVC liners eliminate folds and wrinkles for a neat professional appearance
- Welded PVC cord channel hides pump and light cords for a clean and attractive installation
- Basins are available in tan, grey and black to complement any surround up to eight-feet wide
- Can be used with Atlantic Fountain Nozzles, Copper Bowls and Formal Spillway products – Spillways, WaterWalls and Spouts
- Open basins not recommended for use with Colorfalls, which require a filtered water source for operation

| MODEL | ITEM | LIST | DESCRIPTION | COLOR | DIMENSIONS | CAPACITY | WARRANTY |
|---------|-------|------------|---|-------|------------------|-------------|----------|
| FF4416B | 73788 | \$565.99 | 4' Square Flexible Fountain Basin | Black | 4'W x 4'L x 16"H | 160 gallons | 1-year |
| FF4416G | 73789 | | | Grey | | | |
| FF4416T | 73790 | | | Tan | | | |
| FF4616B | 73791 | \$745.99 | 4' x 6' Rectangular Flexible Fountain Basin | Black | 4'W x 6'L x 16"H | 240 gallons | 1-year |
| FF4616G | 73792 | | | Grey | | | |
| FF4616T | 73793 | | | Tan | | | |
| FF4816B | 73794 | \$934.99 | 4' x 8' Rectangular Flexible Fountain Basin | Black | 4'W x 8'L x 16"H | 320 gallons | 1-year |
| FF4816G | 73795 | | | Grey | | | |
| FF4816T | 73796 | | | Tan | | | |
| FF4016B | 73785 | \$498.99 | 4' Round Flexible Fountain Basin | Black | 4'W x 16"H | 125 gallons | 1-year |
| FF4016G | 73786 | | | Grey | | | |
| FF4016T | 73787 | | | Tan | | | |
| FF6016B | 73797 | \$696.99 | 6' Round Flexible Fountain Basin | Black | 6'W x 16"H | 280 gallons | 1-year |
| FF6016G | 73798 | | | Grey | | | |
| FF6016T | 73799 | | | Tan | | | |
| FF8016B | 73800 | \$1,316.99 | 8' Round Flexible Fountain Basin | Black | 8'W x 16"H | 500 gallons | 1-year |
| FF8016G | 73801 | | | Grey | | | |
| FF8016T | 73802 | | | Tan | | | |

- Atlantic's innovative weight distribution ring with plumbing and lighting ports supports fountain pieces directly on Eco-Blox reservoirs
- The Eco-Rise System solves weight and splash limitations of traditional molded fountain basins with a weight capacity up to 3,000 pounds per Eco-Rise
- The extremely strong radial structure of the Eco-Rise distributes the weight of heavier statuary, vases and columns over 3 Eco-Blox vertical support panels
- Plumb and illuminate any size, number or configuration of decorative fountain pieces



| MODEL | ITEM | LIST | DIMENSIONS | PLUMBING SIZE | MAX LOAD | WARRANTY |
|-----------|-------|----------|-------------------|---------------|------------|----------|
| ECORISE20 | 74970 | \$104.99 | 20"W x 20"D x 3"H | ¾" to 1½" | 3,000 lbs. | Lifetime |

ECO-RISE SYSTEM

- Create reservoirs of practically any size, shape or volume, supporting any number of decorative items, with complete adjustability
- Minimal friction between Eco-Blox and the Eco-Rise and excellent weight distribution over the vertical support panels allow even the heaviest features to be adjusted with little effort
- The Eco-Rise ports allow you to plumb, illuminate and adjust decorative stone or statuary of any size or weight, even while running
- Each PV1700 Pump Vault accommodates up to two pumps and two 3-Way diverters to drive up to six decorative features
- Additional Pump Vaults can be installed for virtually limitless possibilities
- Easily adaptable for rain water harvesting and storm water management

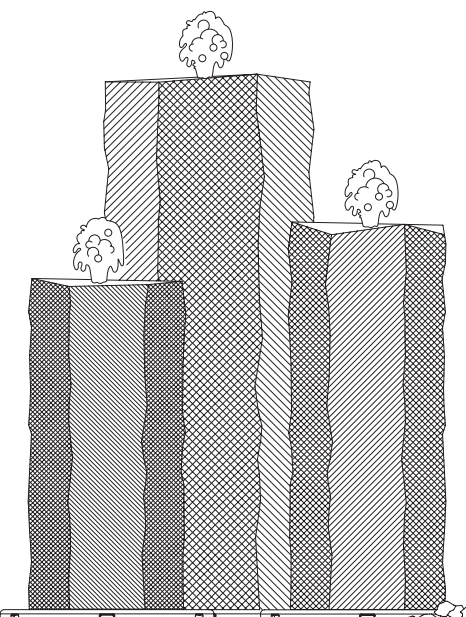

PV1700 Pump Vault shown with 3-Way Diverter installed for use with the Eco-Rise and Eco-Blox



BASALT COLUMNS



- Attractive natural stones are drilled to create overflowing water features
- Hexagonal pillars have a sawn base for stability and snapped top that emphasizes the stone's natural beauty
- Volcanic basalt oxidizes to form attractive multi-colored patina over time
- Atlantic's Basalt Columns are generously core-drilled to 1 7/8" to fit up to 1" Sch 40 PVC or 3/4" kink-free tubing plus a light cord
- A 2" diameter, 5" deep socket recesses Atlantic's Fountain Light and buffers the water plume
- Available in single or three piece sets for design flexibility

| MODEL | ITEM | LIST | ESTIMATED WEIGHT | APPROXIMATE DIMENSIONS | RECOMMENDED BASIN SIZE | RECOMMENDED PUMP | RECOMMENDED PLUMBING KIT | WARRANTY |
|-------|-------|----------|------------------|------------------------|------------------------|------------------|--------------------------|----------|
| NBC24 | 73778 | \$258.99 | 140 lbs. | 10"W x 24"H | FB2400 | FP400 | FBKIT1 | 3-year |
| NBC30 | 73779 | \$309.99 | 175 lbs. | 10"W x 30"H | FB3200 | FP500 | FBKIT1 | 3-year |
| NBC36 | 73780 | \$363.99 | 210 lbs. | 10"W x 36"H | FB4600 | FP500 | FBKIT1 | 3-year |
| NBCX3 | 73781 | \$895.99 | 525 lbs. | --- | FB4600 | TT2000 | FBKIT3 | 3-year |



FKNBC24



FKNBC30



FKNBCX3

- Atlantic Basalt Kits have everything included to create a working water feature with natural stone with minimal time and effort
- Add Fountain Lights in Warm White or Color Changing to create a illuminated torch effect after dark

| MODEL | ITEM | LIST | ESTIMATED WEIGHT | APPROXIMATE DIMENSIONS | BASIN | PUMP | PLUMBING KIT | WARRANTY |
|---------|-------|------------|------------------|------------------------|--------|--------|--------------|----------|
| FKNBC24 | 73809 | \$502.99 | 161 lbs. | 10"W x 24"H | FB2400 | FP400 | FBKIT1 | 3-year |
| FKNBC30 | 73810 | \$797.99 | 209 lbs. | 10"W x 30"H | FB3200 | FP500 | FBKIT1 | 3-year |
| FKNBCX3 | 73811 | \$1,657.99 | 588 lbs. | --- | FB4600 | TT2000 | FBKIT3 | 3-year |



COLOR CHANGING VASES



- Illuminated fountains add the charm of glowing multi-colored light to the sight and sound of flowing water
- Atlantic's Color Changing Vases feature an attractive granite finish during the day and brilliant color at night
- Vase is illuminated from within by Color Changing LED Ring Light with 48 colors and 18 preset modes
- Includes Color Changing Control Module, remote control and transformer
- Wide, stable base allows permanent anchoring or simply cover with gravel for a wind-proof, attractive installation
- Sturdy rotomolded polyethylene construction for durability
- Sold individually or as a 3-piece Vase Set for greater design flexibility

| MODEL | ITEM | LIST | INLET | DIMENSIONS | RECOMMENDED BASIN SIZE | RECOMMENDED PUMP | RECOMMENDED PLUMBING KIT | WARRANTY |
|-----------|-------|----------|--------------------|-------------|------------------------|------------------|--------------------------|----------|
| FTN CCV18 | 73782 | \$248.99 | 3/4" PVC Spig. | 10"W x 18"H | FB2400 | FP200 | FBKIT1 | 5-year |
| FTN CCV24 | 73783 | \$280.99 | 3/4" PVC Spig. | 12"W x 24"H | FB3200 | FP300 | FBKIT1 | 5-year |
| FTN CCV32 | 73784 | \$323.99 | 3/4" PVC Spig. | 14"W x 32"H | FB3200 | FP400 | FBKIT1 | 5-year |
| FTN CCVX3 | 73808 | \$722.99 | (3) 3/4" PVC Spig. | --- | FB4600 | MD1000 | FBKIT3 | 5-year |



- Atlantic's Color Changing Vase Fountain Kit provides everything needed for fast and easy installation
- The perfect introductory water feature provides visual interest day and night
- Minimal setup time and no previous experience needed to create a dramatic landscape focal point
- Add additional Color Changing Lighting to the surrounding area using the included module with optional larger transformer and splitters
- Includes basin, pump with adjustable flow control, vase, Color Changing light, control module, remote, fittings and tubing

| MODEL | ITEM | LIST | DESCRIPTION | BASIN | FOUNTAIN | PUMP | WARRANTY |
|---------|-------|----------|----------------------------------|--------|-------------------------------|------------------|---------------------------|
| FKCCV18 | 73807 | \$410.99 | Color Changing Vase Fountain Kit | FB2400 | FTN CCV18 Color Changing Vase | FP200 & Fittings | 5-year / Basin - Lifetime |



COPPER FOUNTAIN BOWLS



CB30R4

- Fountain Bowls are a stylish and elegant addition to any landscape or hardscape
- Atlantic Copper Fountain Bowls are crafted out of solid copper
- Copper Fountain Bowls may be used alone as a decorative accent in fountains or ponds or to start a waterfall
- Copper Fountain Bowls are designed to form a natural patina over time
- 30" diameter bowl features a 4" spillway for a gentle water flow and calming effect



CB36R0

- 36" Copper Fountain Bowl is designed to overflow around its entire perimeter into either a FB4600 Fountain Basin or an Eco-Rise System
- 30" Copper Fountain Bowl and Pedestal may be used in combination with 36" Copper Fountain Bowl on an Eco-Rise System
- Bowls feature dual 1½" FIPT inlets and standpipe for lighting and water supply
- Dual inlets allow water supply to be plumbed independently from lighting cords. Use the Cord Seal Fitting to pass the light cord into the bowl through the second inlet

| MODEL | ITEM | LIST | DESCRIPTION | FLOW RATE | INLET | DIMENSION | WARRANTY |
|--------|-------|------------|--------------------------------|-----------|--------------|---------------------|----------|
| CB30R4 | 73805 | \$1,498.99 | 30" Copper Bowl w/ 4" Spillway | 750 gph | (2) 1½" FIPT | 30"W x 33"D x 14½"H | 3-year |
| CB36R0 | 73806 | \$1,898.99 | 36" Copper Bowl | 2400 gph | (2) 1½" FIPT | 36"W x 14½"H | 3-year |



COPPER FOUNTAIN BOWLS



CB26R6

- Copper Fountain Bowls are a stylish and elegant addition to any landscape or hardscape
- Atlantic Copper Fountain Bowl and Pedestal are crafted out of solid copper intended to naturally patina over time
- 26" diameter bowl features four 6" spillways, dual 1½" FIPT inlets and standpipe for lighting and water supply
- Spillways are sized at 6" for maximum water flow and visual effect
- Dual inlets allow water supply to be plumbed independently from lighting cords. Use the Cord Seal Fitting to pass the light cord into the bowl through the second inlet

| MODEL | ITEM | LIST | DESCRIPTION | FLOW RATE | INLET | DIMENSION | WARRANTY |
|--------|-------|----------|-------------------------------------|-----------|--------------|--------------------|----------|
| CB26R6 | 73804 | \$899.99 | 26" Copper Bowl w/ (4) 6" Spillways | 2400 gph | (2) 1½" FIPT | 29"W x 29"D x 10"H | 3-year |
| CB16P | 73803 | \$579.99 | Copper Pedestal for Copper Bowls | --- | --- | 16"L x 16"W x 8"H | 3-year |



CB16P

- 26" Copper Fountain Bowl is designed to sit on a FB4600 Fountain Basin on top of the Pedestal
- Pedestal of solid reinforced copper is designed to securely elevate all Copper Fountain Bowls and Copper Spillway Bowls by 8"
- Use 12" Splash Rings with 26" Copper Fountain Bowl on FB4600 to control splash
- Use Eco-Rise plumbing riser under Pedestal to accommodate 1½" supply line. Use a TidalWave Variable Speed Controller to adjust the flow as needed.

TECH TIP

Atlantic's unique Cord Seal Fitting makes the addition of lighting to any Fountain easy and trouble-free. The specially engineered fitting clamps around the cord before inserting into any 1½" slip PVC socket. Tightening the fitting expands the rubber gasket against both the cord and the inside of the fitting with a leak-proof seal. The Cord Seal Fitting includes stainless steel screws for durability and longevity. Page 93



DID YOU KNOW?

Atlantic's Copper Fountain Bowls have a thin lacquer coating to prevent unwanted tarnishing but will develop a beautiful natural patina over time. The patina will appear first where water flows over the copper. If desired, any copper cleanser can be used to restore the natural copper luster in applications that do not have fish, plants or wildlife.

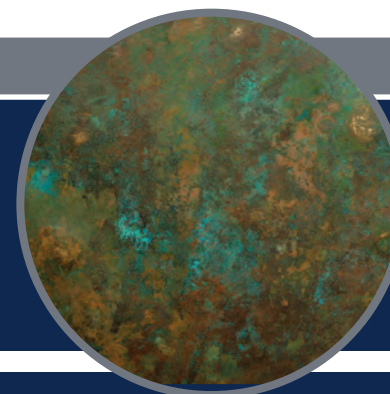



FOUNTAIN NOZZLES

- Nozzles direct water in decorative patterns or shapes in fountain applications
- Atlantic's Nozzles are designed to take advantage of higher volume, lower pressure, energy-efficient asynchronous pumps
- Higher volume Nozzles with larger openings are less susceptible to clogging and wind deflection
- Atlantic Nozzles are 304 stainless steel for performance and longevity
- Stainless steel Nozzle Adjustment Base allows for vertical alignment of any nozzle, up to 15° off vertical

VERTICAL NOZZLES

- Cascade Column Nozzle creates a thick column by inducting water
- Appearance will vary depending on water level
- Wind resistant jet designed for larger water features

| MODEL | ITEM | LIST | DESCRIPTION | INLET | DIMENSIONS | WARRANTY |
|--------|-------|---------|-----------------------|----------|------------|----------|
| FNCC15 | 73829 | \$64.99 | Cascade Column Nozzle | 1½" MIPT | 2"W x 6½"H | 3-year |

| MODEL | SPRAY HEIGHT | 2' | 4' | 6' | 8' | 10' | 12' |
|--------|--------------|-----------|------------|------------|------------|-------------|-------------|
| FNCC15 | GPM / GPH | 18 / 1080 | 22 / 1320 | 26 / 1560 | 30 / 1800 | 34 / 2040 | 38 / 2280 |
| | PSI / HEAD | 2.8 / 6.5 | 5.0 / 11.5 | 6.9 / 16.0 | 8.9 / 20.5 | 11.1 / 25.5 | 13.5 / 31.0 |



- Multi-Jet Nozzle creates thick vertical column with 17 jets
- Nozzle functions independently of water level
- Wind resistant jet designed for larger water features

| MODEL | ITEM | LIST | DESCRIPTION | INLET | DIMENSIONS | WARRANTY |
|--------|-------|----------|-------------------------|----------|------------|----------|
| FNMJ15 | 73833 | \$106.99 | Multi-Jet Column Nozzle | 1½" MIPT | 4"W x 4½"H | 3-year |

| MODEL | SPRAY HEIGHT | 2' | 4' | 6' | 8' | 10' | 12' |
|--------|--------------|-----------|-----------|------------|------------|------------|------------|
| FNMJ15 | GPM / GPH | 30 / 1800 | 40 / 2400 | 48 / 2880 | 56 / 3360 | 63 / 3780 | 69 / 4080 |
| | PSI / HEAD | 0.9 / 2.0 | 3.0 / 7.0 | 4.3 / 10.0 | 5.9 / 13.5 | 7.4 / 17.0 | 8.9 / 20.5 |



- Frothy Nozzle creates a "frothy" appearance by inducting air
- Nozzle functions independently of water level
- Wind resistant jet with adjustable orifice to tune exact height, for small to medium fountains

| MODEL | ITEM | LIST | DESCRIPTION | INLET | DIMENSIONS | WARRANTY |
|--------|-------|---------|--------------------------|---------|------------|----------|
| FNAF10 | 73827 | \$74.99 | Adjustable Frothy Nozzle | 1" MIPT | 2½"W x 6"H | 3-year |

| MODEL | SPRAY HEIGHT | 2' | 4' | 6' | 8' | 10' | 12' |
|--------|--------------|-----------|------------|------------|------------|-------------|-------------|
| FNAF10 | GPM / GPH | 16 / 960 | 22 / 1320 | 26 / 1560 | 30 / 1800 | 34 / 2040 | 38 / 2280 |
| | PSI / HEAD | 2.0 / 4.5 | 4.3 / 10.0 | 6.5 / 15.0 | 8.7 / 20.0 | 11.1 / 25.5 | 13.9 / 32.0 |



HORIZONTAL NOZZLES

- Arching Spray Nozzle creates single central jet and 18 arching sprays
- Nozzle functions independently of water level
- Best for circular patterns in larger fountains
- Wind-resistant circular pattern

| MODEL | ITEM | LIST | DESCRIPTION | INLET | DIMENSIONS | WARRANTY |
|--------|-------|---------|----------------------|----------|-------------|----------|
| FNAS15 | 73828 | \$74.99 | Arching Spray Nozzle | 1½" FIPT | 3¼"W x 4½"H | 3-year |

| MODEL | SPRAY HEIGHT | 2' | 4' | 6' | 8' | 10' |
|--------|--------------|-----------|-----------|-----------|-----------|------------|
| FNAS15 | GPM / GPH | 20 / 1200 | 27 / 1620 | 33 / 1980 | 38 / 2280 | 43 / 2580 |
| | PSI / HEAD | 0.9 / 2.0 | 1.7 / 4.0 | 2.8 / 6.5 | 3.9 / 9.0 | 4.8 / 11.0 |
| | SPREAD | 6' | 9' | 12' | 15' | 18' |



- Horizontal Cone adjusts height and width with center cap
- Nozzle functions independently of water level

| MODEL | ITEM | LIST | DESCRIPTION | INLET | DIMENSIONS | WARRANTY |
|--------|-------|---------|------------------------|----------|------------|----------|
| FNHC15 | 73832 | \$64.99 | Horizontal Cone Nozzle | 1½" MIPT | 2"W x 6"H | 3-year |

| MODEL | SPRAY HEIGHT | 2' | 4' | 6' | 8' | 10' |
|--------|--------------|-----------|-----------|------------|------------|-------------|
| FNHC15 | GPM / GPH | 23 / 1380 | 35 / 2100 | 46 / 2760 | 60 / 3600 | 75 / 4500 |
| | PSI / HEAD | 0.9 / 2.0 | 2.6 / 6.0 | 4.6 / 10.5 | 8.0 / 18.5 | 12.2 / 28.0 |
| | SPREAD | 8' | 16' | 20' | 25' | 30' |



DIRECTIONAL NOZZLES

- Fan Nozzle features adjustable ball-and-socket mount
- Nozzle functions independently of water level
- Best used to create a solid curtain accent when mounted at a 45° angle

| MODEL | ITEM | LIST | DESCRIPTION | INLET | DIMENSIONS | WARRANTY |
|--------|-------|---------|------------------------|---------|------------|----------|
| FNDF10 | 73830 | \$64.99 | Directional Fan Nozzle | 1" FIPT | 3"W x 6"H | 3-year |

| MODEL | SPRAY HEIGHT | 2' | 4' | 6' | 8' | 10' |
|--------|--------------|-----------|-----------|-----------|------------|------------|
| FNDF10 | GPM / GPH | 14 / 840 | 20 / 1200 | 26 / 1560 | 31 / 1860 | 36 / 2160 |
| | PSI / HEAD | 0.9 / 2.0 | 2.0 / 4.5 | 3.9 / 9.0 | 4.6 / 10.5 | 6.9 / 16.0 |



- Directional Jet Nozzle adjusts with ball-and-socket mount
- Nozzle functions independently of water level
- Best used to create arching single sprays when mounted at a 45° angle

| MODEL | ITEM | LIST | DESCRIPTION | INLET | DIMENSIONS | WARRANTY |
|--------|-------|---------|------------------------|---------|------------|----------|
| FNDJ10 | 73831 | \$34.99 | Directional Jet Nozzle | 1" FIPT | 1¼"W x 5"H | 3-year |

| MODEL | SPRAY HEIGHT | 2' | 4' | 6' | 8' | 10' |
|--------|--------------|-----------|-----------|-----------|-----------|------------|
| FNDJ10 | GPM / GPH | 2 / 120 | 3 / 180 | 4 / 240 | 5 / 300 | 6 / 360 |
| | PSI / HEAD | 0.7 / 1.5 | 1.5 / 3.5 | 2.6 / 6.0 | 3.5 / 8.0 | 4.6 / 10.5 |



- Nozzle Adjustment Base corrects misalignment of up to 15° off vertical

| MODEL | ITEM | LIST | DESCRIPTION | INLET | DIMENSIONS | WARRANTY |
|--------|-------|----------|------------------------|----------|------------|----------|
| FNAB15 | 73826 | \$106.99 | Nozzle Adjustment Base | 1½" MIPT | 4"W x 3"H | 3-year |





FOUNTAIN NOZZLES

4-PATTERN NOZZLE SET

- Nozzles create decorative displays of water in small reservoirs
- OASE Nozzle Set creates attractive displays connected directly to Fountain Pumps with ½" MIPT outlets
- Aerates and decorates ponds, fountains, and containers
- Diverter valve with adjustable flow control allows for separate circulation of reservoir during operation of fountain nozzle
- 4-Pattern Nozzle Set features telescoping nozzle, diverter valve, flow control and 4 different heads that are easily interchangeable



| ITEM | LIST | DESCRIPTION | MIN HEIGHT | MAX HEIGHT | INLET | FOR USE WITH | WARRANTY |
|-------|---------|----------------------|------------|------------|---------|-------------------------------------|----------|
| 51262 | \$22.99 | 4-Pattern Nozzle Set | 11" | 15¾" | ½" FIPT | Fountain Pumps with ½" MIPT outlets | 1-year |

4 SPRAY PATTERNS



BELL



TRUMPET



ARCH



2-TIER

| | GPH | 100 | 300 | 500 |
|---------|--------|-----|-----|-----|
| BELL | HEIGHT | - | - | - |
| | SPREAD | 11" | 15" | 20" |
| TRUMPET | HEIGHT | 10" | 12" | 10" |
| | SPREAD | 16" | 20" | 24" |
| ARCH | HEIGHT | 10" | 10" | 21" |
| | SPREAD | 14" | 10" | 21" |
| 2-TIER | HEIGHT | 20" | 32" | 44" |
| | SPREAD | 30" | 40" | 55" |

VULKAN 37-2.5 K

- Creates a dramatic, eye-catching vertical spray
- Made of durable plastic

| ITEM | LIST | DESCRIPTION | INLET | DIMENSIONS | WARRANTY |
|-------|---------|-----------------|---------|------------|----------|
| 55882 | \$33.99 | Vulkan 37-2.5 K | 1" MIPT | 3"W x 6"H | 1-year |

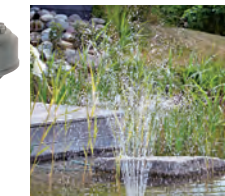

| ITEM | SPRAY HEIGHT | 2' | 4' | 6' | 8' | 10' | 12' |
|-------|--------------|-----------|-----------|------------|-----------|------------|------------|
| 55882 | GPM / GPH | 8 / 450 | 11 / 660 | 13.5 / 810 | 16 / 960 | 18 / 1050 | 20 / 1200 |
| | PSI / HEAD | 1.5 / 3.5 | 2.1 / 4.8 | 2.8 / 6.5 | 3.6 / 8.3 | 4.5 / 10.5 | 5.9 / 13.5 |
| | SPREAD | 22" | 40" | 62" | 75" | 88" | 108" |

FROTHY 35-10 E

- Mixes air and water to create a bubbly white water effect
- Made of durable plastic and metal
- Reflects light better than classic spray patterns

| ITEM | LIST | DESCRIPTION | INLET | DIMENSIONS | WARRANTY |
|-------|----------|----------------|---------|------------|----------|
| 53224 | \$118.99 | Frothy 35-10 E | 1" MIPT | 3"W x 9½"H | 3-year |

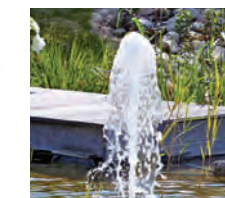

| ITEM | SPRAY HEIGHT | 2' | 4' | 6' | 8' |
|-------|--------------|-----------|------------|------------|-----------|
| 53224 | GPM / GPH | 17 / 990 | 24 / 1410 | 28 / 1680 | 32 / 1890 |
| | PSI / HEAD | 2.6 / 6.0 | 4.9 / 11.5 | 6.9 / 16.0 | 9.1 / 21 |
| | SPREAD | 12" | 28" | 16" | 18" |

LAVA 36-10 K

- Produces a bell-shaped water wall with an arcing display
- Made of durable plastic

| ITEM | LIST | DESCRIPTION | INLET | DIMENSIONS | WARRANTY |
|-------|---------|--------------|---------|------------|----------|
| 55881 | \$33.99 | Lava 36-10 K | 1" MIPT | 3"W x 6"H | 1-year |



| ITEM | SPREAD | 24" | 28" | 32" | 36" |
|-------|------------|------------|------------|------------|------------|
| 55881 | GPM / GPH | 10.5 / 630 | 11 / 660 | 11.5 / 690 | 12 / 720 |
| | PSI / HEAD | 0.87 / 2.0 | 0.97 / 2.3 | 1.08 / 2.5 | 1.26 / 2.9 |

NOZZLE EXTENSION

- Allows adjustment of Fountain Nozzle display height
- Telescoping Extension is constructed of durable plastic

| ITEM | LIST | DESCRIPTION | MIN HEIGHT | MAX HEIGHT | INLET | WARRANTY |
|-------|---------|------------------|------------|------------|---------|----------|
| 53227 | \$33.99 | Nozzle Extension | 11" | 20" | 1" MIPT | 1-year |



WATER TRIO & QUINTET



50353

- Water entertainment combines water and light for visual interest in the landscape
- OASE Water Trio and Quintet include everything you need to create an enchanting water feature right out of the box
- Nine pre-programmed effects vary both fountain height and light intensity
- Integrated memory function returns unit to last programmed channel in the event of a power outage or when using a timer
- Robust floor plate adapts to a wide variety of substrates and protects unit against damage



50354

- Each individually adjustable nozzle projects a ¼" jet illuminated by 6 bright white LEDs
- Compact, easy to conceal external control system features a remote with a range of up to 250 feet without obstruction and connect up to 5 systems controlling 10 jets
- Includes 12 volt pumps, nozzles with extensions, remote control, external control unit with weather resistant cover, ground stake, 120 volt outdoor transformer and cables



| ITEM | LIST | DESCRIPTION | MAX HEIGHT | WATTS | DIMENSIONS | CONTROL BOX DIMENSIONS | WARRANTY |
|-------|------------|---------------|------------|-------|--------------------|------------------------|----------|
| 50353 | \$852.99 | Water Trio | 55" | 40 | 17"W x 12"D x 9½"H | 8½"L x 7¼"W x 12"H | 3-year |
| 50354 | \$1,097.99 | Water Quintet | 55" | 50 | 17"W x 12"D x 9½"H | 8½"L x 7¼"W x 12"H | 3-year |

DID YOU KNOW?

Both the Trio and Quintet can be disassembled and unmounted from the floor plate to enter Creative Mode. Simply remove the cover and unscrew the pumps from the floor plate. The generous 26' cables allow each pump and nozzle assembly to be located remotely in any configuration you desire. Pumps may be set as deep as 8" below the surface of the water with included 4" extensions.



WATER JET LIGHTNING

- Laminar water projectors shoot a continuous, unbroken stream of water
- OASE Water Jet Lightning Kit creates dual illuminated laminar water arches to dazzle and delight right out of the box
- Four pre-programmed effects with variations in jet height, jet lengths, and RGB colors
- High quality stainless steel base can be bolted onto different substrates
- With remotely located pump, jet units can be placed in or out of water
- Adjustable base plate pivots from 45° to 90°, allowing for a variety of jet shapes
- Compact, easy to conceal external control system features a remote with a range of up to 250 feet without obstruction and connect up to 5 systems controlling 10 jets
- Integrated memory function returns unit to last programmed channel in the event of a power outage or when using a timer
- Includes 2 jet units, 12 volt pump, 20' roll of tubing, remote control, external control unit with weather resistant cover, ground stake, 120 volt outdoor transformer and cables



| ITEM | LIST | DESCRIPTION | MAX HEIGHT AT 90° | MAX DISTANCE AT 45° | WATTS | DIMENSIONS | CONTROL BOX DIMENSIONS | WARRANTY |
|-------|------------|---------------------|-------------------|---------------------|-------|------------------|------------------------|----------|
| 50355 | \$1,097.99 | Water Jet Lightning | 36" | 58" | 41 | 6"L x 4½"W x 8"H | 8½"L x 7"W x 12"H | 3-year |

TECH TIP

The Water Jet Lightning achieves a perfect unbroken tube of water by creating a laminar flow in the same way our Colorfalls creates a laminar sheet of water. All the bubbles and turbulence have been removed and all of the water is moving in the same direction. Because water is attracted to itself, its strong cohesion aligns the water surface in a clean cylinder as it is emitted from the jet unit. The other remarkable attribute of laminar water flow is that it can carry light, in the same way as fiber optics can. Protect the stream from wind to maintain its perfect appearance.



FS FORMAL SPILLWAY

Atlantic's Formal Spillway System makes easy work of adding the charm of running water to new or existing landscape or hardscape walls. Minimal noise and splash make this system ideal for indoor applications. Convenient Basin Kits include everything needed for installation, saving time and money. All components are matched for perfect performance every time.

- » Double filter mats keep debris out of the system, eliminating time consuming cleanouts
- » Basin Kits require no guesswork for installation and accommodate four spillway options
- » Dimensions of basins work well with all engineered stone systems
- » High efficiency pumps and top quality components keep cost of operation minimal
- » Water flow is adjustable to achieve the perfect effect regardless of location
- » The rigid basins are completely weatherproof and carry a lifetime warranty



- 1 Formal Spillway Basins are seamless, leak-proof and molded in sizes that complement most modular wall and paving systems, for easy installation and minimal cutting.
- 2 Built-in recesses route all the plumbing beneath the basin, including Auto Fill feed lines and low voltage wiring for accent lighting.
- 3 Basin Kits include all plumbing and fittings needed for installation, with a single union ball valve for easy pump removal and adjustment of water flow to the spillway.
- 4 All plumbing is contained inside the perimeter of the basin, allowing retaining wall blocks to surround the basin with no notching or cutting.



- 5 Internal Matala mat prevents any debris from entering the pump and spillway, filtering the water and diffusing turbulence for even water flow from the spillway.
- 6 Large pump chamber accommodates the appropriate TidalWave pump with room for the installation of an Auto Fill Valve.
- 7 Complete Basin Kits work interchangeably with all Atlantic Formal Spillway styles: Colorfalls, Color Changing Colorfalls and Spillways.

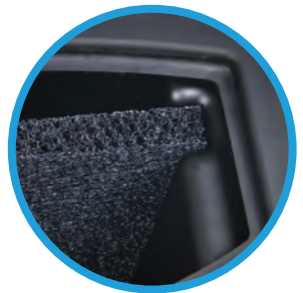

- 8 Atlantic Splash Rings keep stones in place and splash at bay as effectively as our Splash Mats, but with the appeal of steel and copper. Add an LED Ring Light under the mesh to illuminate the falls from below.





COMPLETE BASIN KITS

BASINS & ACCESSORIES



CFBASINKIT12

CFBASINKIT24

CFBASINKIT36

- The heart of Atlantic Formal Spillway Systems, Basin Kits provide everything you need to install Colorfalls, WaterWalls and Spillways
- Three sizes of self-contained basins, complete with pumps and plumbing, accommodate 12, 24 and 36-inch Formal Spillways

- Seamless installation with four-inch garden block
- Basin Kits include basin, Splash Mat, pump, plumbing, PVC glue, adjustment valve and Auto Fill, all in one box

| MODEL | ITEM | LIST | DESCRIPTION | FOR USE WITH | DIMENSIONS | PUMP | WARRANTY |
|--------------|-------|------------|--------------------|------------------------|--------------------|--------|-----------------------------------|
| CFBASINKIT12 | 73849 | \$718.99 | Complete Basin Kit | All 6" & 12" Spillways | 20"W x 20"D x 16"H | TT1500 | Basin - Lifetime Pump - 3-year |
| CFBASINKIT24 | 73850 | \$834.99 | Complete Basin Kit | All 24" Spillways | 44"W x 22"D x 16"H | TT3000 | Basin - Lifetime Pump - 3-year |
| CFBASINKIT36 | 73851 | \$1,085.99 | Complete Basin Kit | All 36" Spillways | 56"W x 24"D x 16"H | TT4000 | Basin - Lifetime Pump - 3-year |

FORMAL SPILLWAY BASINS



CFBASIN12



CFBASIN24



CFBASIN36

| MODEL | ITEM | LIST | DIMENSIONS | CAPACITY | FILTERING | WARRANTY |
|-----------|-------|----------|--------------------|------------|-------------------|----------|
| CFBASIN12 | 73852 | \$328.99 | 20"L x 20"W x 16"H | 18 gallons | Matala Filter Mat | Lifetime |
| CFBASIN24 | 74232 | \$379.99 | 44"L x 22"W x 16"H | 33 gallons | Matala Filter Mat | Lifetime |
| CFBASIN36 | 74233 | \$430.99 | 56"L x 24"W x 16"H | 42 gallons | Matala Filter Mat | Lifetime |

ACCESSORIES



CFSPMA12



CFSPMA24



CFSPMA36

| MODEL | ITEM | LIST | DESCRIPTION | DIMENSIONS | FOR USE WITH | WARRANTY |
|------------|-------|----------|-----------------|-------------|----------------------|----------|
| CFSPMA12 | 73845 | \$37.99 | Splash Mat | 17"L x 17"W | CFBASIN12 | 1-year |
| CFSPMA24 | 74230 | \$56.99 | Splash Mat | 41"L x 19"W | CFBASIN24 | 1-year |
| CFSPMA36 | 74231 | \$74.99 | Splash Mat | 53"L x 21"W | CFBASIN36 | 1-year |
| CFSPMA2820 | 73846 | \$234.99 | Splash Mat Roll | 20'L x 28"W | Custom Installations | 1-year |

TECH TIP

Atlantic's Basin Kits come with everything needed to create a fully functioning water feature with any single Formal Spillway. Simply choose the appropriate width Basin Kit. For multiple Spillway installations, double or triple Wall Spout installations or Spillway and double Spout installations, you will need to add tees and valves and create a manifold to accommodate the additional water outlets. See page 150 for valved manifold examples.

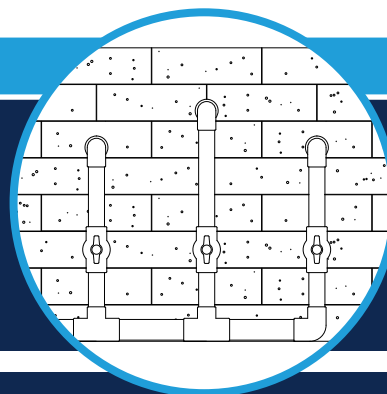



FLEXIBLE HARDSCAPE BASINS



FF4216B
FF6216B
FF8216B

FF4216G
FF6216G
FF8216G

FF4216T
FF6216T
FF8216T

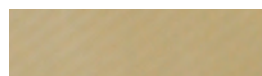
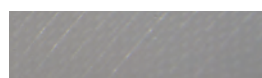

- For those applications that require an open basin, Atlantic's Flexible Basins are the easiest way to waterproof your block installation
- Reinforced 28mil PVC construction with fold out flaps and punched glue points anchor liner under capstones for security and durability
- Unlike improvised EPDM liner basins, welded corner construction eliminates folds and wrinkles for a neat professional appearance
- Basins are available in tan, grey and black to complement any surround up to eight-feet wide
- Includes backing plates and bulkheads for submersible or external pumps. Use Cord Seal Fittings to pass cords
- Perfect for Atlantic's Spillway, WaterWall and Wall Spout installations. Open basins not recommended for Colorfalls applications

| MODEL | ITEM | LIST | COLOR | FOR USE WITH | DIMENSIONS | CAPACITY | BULKHEAD | WARRANTY |
|---------|-------|----------|-------|-------------------------------------|------------------|-------------|---------------------------|----------|
| FF4216B | 73836 | \$359.99 | Black | Spillways, WaterWalls & Wall Spouts | 4'W x 2'D x 16"H | 80 gallons | 1½" w/ Backing Plate | 1-year |
| FF4216G | 73837 | | Grey | | | | | |
| FF4216T | 73838 | | Tan | | | | | |
| FF6216B | 73839 | \$452.99 | Black | Spillways, WaterWalls & Wall Spouts | 6'W x 2'D x 16"H | 120 gallons | (2) 1½" w/ Backing Plates | 1-year |
| FF6216G | 73840 | | Grey | | | | | |
| FF6216T | 73841 | | Tan | | | | | |
| FF8216B | 73842 | \$506.99 | Black | Spillways, WaterWalls & Wall Spouts | 8'W x 2'D x 16"H | 160 gallons | (2) 1½" w/ Backing Plates | 1-year |
| FF8216G | 73843 | | Grey | | | | | |
| FF8216T | 73844 | | Tan | | | | | |

TECH TIP

You can use the same plumbing line to flow water and pass an electrical cord of a submersible pump or light through the wall of an Atlantic Flexible Hardscape Basin. Install a Tee on each side of the bulkhead in the wall of the basin. Run the cord through a Cord Seal Fitting in the inside tee to another in the outside tee leaving enough slack for servicing pump before tightening.



TECH TIP

Copper Bowls lend themselves to a number of lighting options. External Spotlights are a great way to accent water overflowing the 36" Copper Bowl or the concentrated flow from spillways. Inside the bowl, the submersible Ring Light creates rippling uplighting effects on overhanging trees or structures. Install Atlantic's unique Cord Seal Fitting to make lighting inside the Bowl possible without a visible cord coming over the edge. The rubber fitting installs in the off-center 1½" FIPT inlet and expands when tightened, sealing the cord and the inlet.

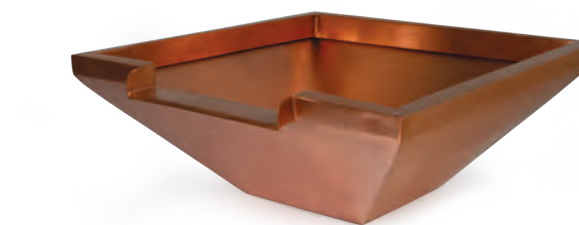

CB26S12

- Spillway Bowls complement any hardscape, landscape or poolscape with the elegance of copper
- Atlantic Copper Spillway Bowls are crafted out of solid copper in both round and square styles
- Copper Spillway Bowls are designed to form a natural patina over time
- All spillways are sized at 12" for maximum water flow and visual effect
- All Bowls feature dual 1½" FIPT inlets and solid copper standpipe for lighting and water supply



CB26R12

- Dual inlets allow water supply to be plumbed independently from lighting cords. Use Atlantic's Cord Seal Fitting to pass the light cord into the bowl through the second inlet
- Solid Copper Pedestal accessory allows bowls to be elevated 8"
- Copper Spillway Bowls are designed to work with the CFBASINKIT12
- Use a 12" Splash Ring on the 12" Formal Spillway Basin to control splash

| MODEL | ITEM | LIST | DESCRIPTION | FLOW RATE | INLET | DIMENSION | WARRANTY |
|---------|-------|----------|--|-----------|--------------|---------------------|----------|
| CB26S12 | 73854 | \$799.99 | 26" Square Copper Bowl w/ 12" Spillway | 1200 gph | (2) 1½" FIPT | 26"W x 27½"D x 10"H | 3-year |
| CB26R12 | 73853 | \$799.99 | 26" Round Copper Bowl w/ 12" Spillway | 1200 gph | (2) 1½" FIPT | 26"W x 27½"D x 10"H | 3-year |



WALL SPOUTS



WSCM-S (Copper)
WSM-S (Bronze)



WSCR-O (Copper)
WSR-O (Bronze)



WSCV-S (Copper)
WSV-S (Bronze)



WSCO-O (Copper)
WSO-O (Bronze)

- Wall Spouts are an easy and elegant way to add the sight and sound of water to vertical surfaces
- Atlantic Wall Spouts complement larger spillways when paired; use alone to accent smaller spaces
- Solid brass fixtures add a captivating focal point to both traditional and contemporary walls and patios
- Choose from four architectural designs with oil rubbed bronze or antique copper finish to fit any style
- Integrated drip edge to eliminate backflow down the wall
- Includes grounding lug for bonded systems
- For use with Formal Spillway and Flexible Hardscape Basins

| MODEL | ITEM | LIST | DESCRIPTION | FLOW RATE | PROJECTION* | INLET | DIMENSIONS | WARRANTY |
|--------|-------|----------|-------------|-----------|-----------------------------|----------|------------------|----------|
| WSCM-S | 73867 | \$184.99 | Mantova | 600 gph | 14" - 16" at 18"H & 600 gph | 1½" FIPT | 5"W x 4¾"D x 5"H | 3-year |
| WSM-S | 73871 | | | | | | | |
| WSCR-O | 73869 | \$184.99 | Ravenna | 600 gph | 14" - 16" at 18"H & 600 gph | 1½" FIPT | 5"W x 5¾"D x 6"H | 3-year |
| WSR-O | 73873 | | | | | | | |
| WSCV-S | 73870 | \$184.99 | Verona | 600 gph | 14" - 16" at 18"H & 600 gph | 1½" FIPT | 7"W x 4¾"D x 7"H | 3-year |
| WSV-S | 73875 | | | | | | | |
| WSCO-O | 73868 | \$184.99 | Olivett | 600 gph | 14" - 16" at 18"H & 600 gph | 1½" FIPT | 6"W x 4½"D x 5"H | 3-year |
| WSO-O | 73872 | | | | | | | |

* Projection is measured from the face of the wall the Spout is mounted on

TECH TIP

Atlantic's unique Spout Lights illuminate the water from inside the plumbing. With 600 gallons per hour or more, the minimum flow required to submerge the light fixture in the plumbing, Warm White or Color Changing light is carried inside the laminar water flow. Synchronize Spout Lights with the entire Atlantic Lighting System. Page 103

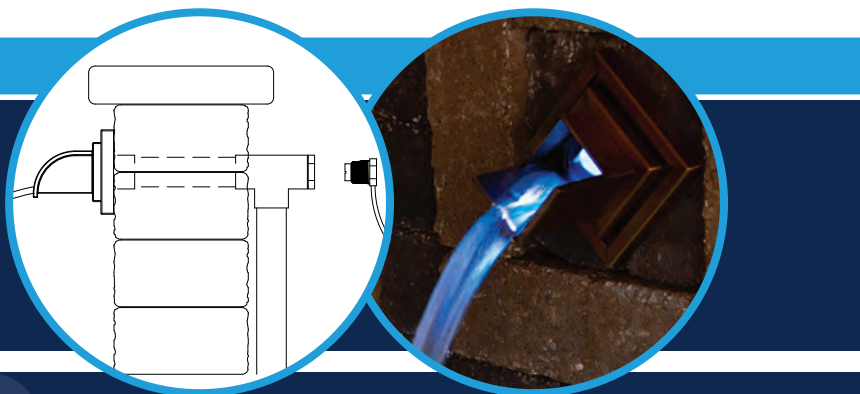

COLORFALLS



CF12B (Ice Blue)
CF12W (Crystal White)
CF12SW (SOL White)



CF24B (Ice Blue)
CF24W (Crystal White)
CF24SW (SOL White)



CF36B (Ice Blue)
CF36W (Crystal White)
CF36SW (SOL White)

- Colorfalls produce a sheer of lighted water emerging from a concealed source inside vertical walls
- Colorfalls adapt to any wall material - pavers, tile, brick, stone, wood - the only limit is your imagination
- Replaceable LED light bar available in three vibrant colors
- Colorfalls feature a 5" lip, 30' power cord and includes a 12 volt outdoor transformer
- For use with Formal Spillway Basins and Basin Kits

| MODEL | ITEM | LIST | FLOW RATE | PROJECTION* | INPUT VOLTAGE | WATTS | INLET | DIMENSIONS | WARRANTY |
|--------|-------|----------|-----------|---|---------------|-------|----------|-------------------|----------|
| CF12B | 73883 | \$204.99 | 1,000 gph | 13" - 15" at 18"H & 1,000 gph (Rec. Height: 20" max.) | 12 volt AC | 3 | 1½" FIPT | 12"W x 8"D x 3½"H | 1-year |
| CF12W | 73885 | | | | | | | | |
| CF12SW | 73884 | | | | | | | | |
| CF24B | 73886 | \$308.99 | 2,000 gph | 13" - 15" at 18"H & 2,000 gph (Rec. Height: 30" max.) | 12 volt AC | 6 | 1½" FIPT | 24"W x 8"D x 3½"H | 1-year |
| CF24W | 73888 | | | | | | | | |
| CF24SW | 73887 | | | | | | | | |
| CF36B | 73889 | \$399.99 | 3,000 gph | 13" - 15" at 18"H & 3,000 gph (Rec. Height: 40" max.) | 12 volt AC | 9 | 1½" FIPT | 36"W x 8"D x 3½"H | 1-year |
| CF36W | 73891 | | | | | | | | |
| CF36SW | 73890 | | | | | | | | |

* Projection is measured from the face of the wall the Colorfalls is installed in

3 VIBRANT COLORS



ReFresh Colorfalls & Fountain Treatment on page 116



COLOR CHANGING COLORFALLS

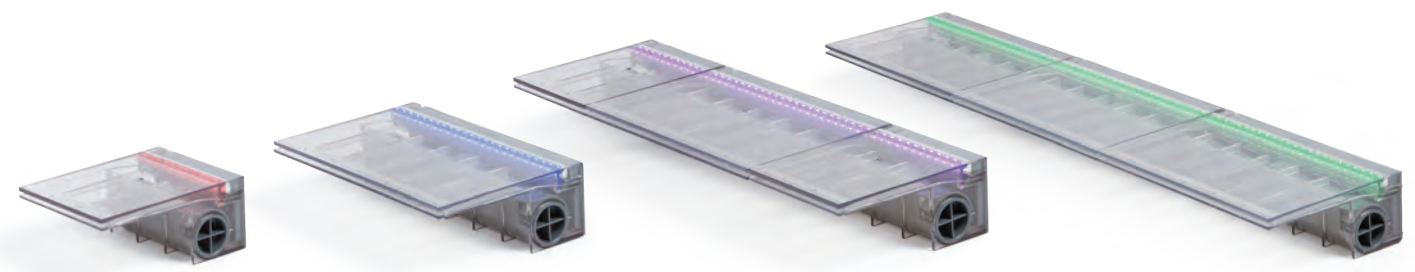

- | | | | |
|--|---|---|---|
| <p>CC06</p> <ul style="list-style-type: none"> • Illuminated waterfalls are the most versatile way to add light and water to your landscape or hardscape • Atlantic's Color Changing Colorfalls are the first modular sheer descent system with multiple light and configuration options • Design custom colors, select transitions and create personalized sequences with the new InfiColor Smart Module and App • Color Changing Colorfalls synchronize with Atlantic Hardscape and submersible lights to create illuminated landscapes • Unlike other sheer descent waterfalls, Atlantic Color Changing Colorfalls may be linked together to create waterfalls of any width • Synchronize multiple Colorfalls with InfiColor 3 Light Wiring Kit (CCSM30X3), additional splitters (CCBSX4) and larger transformer | <p>CC12</p> <ul style="list-style-type: none"> • Designed to install easily in any wall, indoors or out, whether stone, brick, block, stucco, tile or wood • Atlantic's Color Changing Colorfalls' modular body style offers multiple inlets for maximum plumbing flexibility • Generous weir openings resist clogging and create a thicker, fuller sheer for extra color and less wind deflection • Colorfalls feature a 5" lip, 20' power cord and includes single outlet InfiColor Smart Module and 12V outdoor transformer • For use with Formal Spillway Basins and Basin Kits | <p>CC24</p> <ul style="list-style-type: none"> • Designed to install easily in any wall, indoors or out, whether stone, brick, block, stucco, tile or wood • Atlantic's Color Changing Colorfalls' modular body style offers multiple inlets for maximum plumbing flexibility • Generous weir openings resist clogging and create a thicker, fuller sheer for extra color and less wind deflection • Colorfalls feature a 5" lip, 20' power cord and includes single outlet InfiColor Smart Module and 12V outdoor transformer • For use with Formal Spillway Basins and Basin Kits | <p>CC36</p> <ul style="list-style-type: none"> • Designed to install easily in any wall, indoors or out, whether stone, brick, block, stucco, tile or wood • Atlantic's Color Changing Colorfalls' modular body style offers multiple inlets for maximum plumbing flexibility • Generous weir openings resist clogging and create a thicker, fuller sheer for extra color and less wind deflection • Colorfalls feature a 5" lip, 20' power cord and includes single outlet InfiColor Smart Module and 12V outdoor transformer • For use with Formal Spillway Basins and Basin Kits |
|--|---|---|---|

| MODEL | ITEM | LIST | FLOW RATE | PROJECTION* | INPUT VOLTAGE | WATTS | INLET | DIMENSIONS | WARRANTY |
|-------|-------|----------|-----------|--|---------------|-------|----------|-------------------|----------|
| CC06 | 73878 | \$265.99 | 600 gph | 8" - 10" at 18"H & 600 gph (Rec. Height: 20" max.) | InfiColor | 3 | 1½" FIPT | 6"W x 8"D x 3½"H | 1-year |
| CC12 | 73879 | \$313.99 | 1,200 gph | 8" - 10" at 18"H & 1,200 gph (Rec. Height: 20" max.) | InfiColor | 5 | 1½" FIPT | 12"W x 8"D x 3½"H | 1-year |
| CC24 | 73880 | \$508.99 | 2,400 gph | 8" - 10" at 18"H & 2,400 gph (Rec. Height: 30" max.) | InfiColor | 10 | 1½" FIPT | 24"W x 8"D x 3½"H | 1-year |
| CC36 | 73881 | \$644.99 | 3,600 gph | 8" - 10" at 18"H & 3,600 gph (Rec. Height: 40" max.) | InfiColor | 15 | 1½" FIPT | 36"W x 8"D x 3½"H | 1-year |

* Projection is measured from the face of the wall the Colorfalls is installed in

COLOR CHANGING COLORFALLS FEATURES:

1. Large weir opening produces a thick sheer for less wind deflection, more color and less chance of clogging.
2. Internal lip supports eliminate splitting of the water sheer.
3. 1½" FIPT inlets on both sides and back for maximum plumbing options and versatility.
4. Includes (2) 1½" plugs for unused plumbing inlets.
5. Self-draining body for easy winterization.
6. Removable baffle for easy cleaning and servicing.
7. Color Changing LED light bar is accessible from the rear of the unit for servicing.
8. Removable back plate provides access to the interior and light bar for routine maintenance.
9. Threaded adapter with silicone O-rings to connect multiple Color Changing Colorfalls.

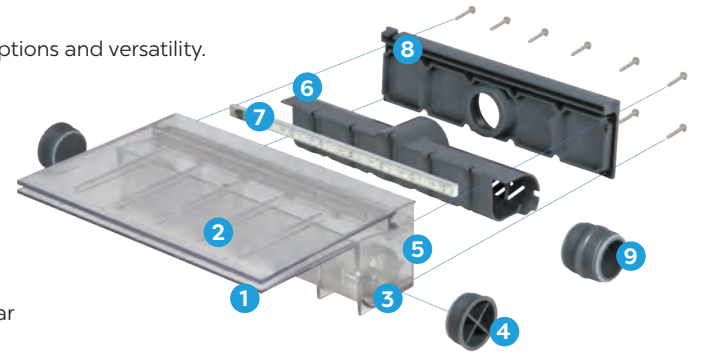

SINGLE-ZONE INFICOLOR SMART MODULE & APP:

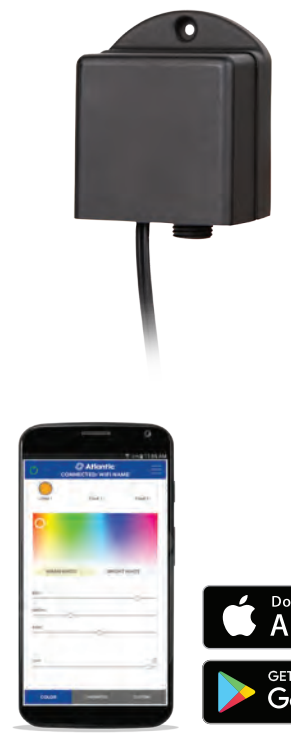

The InfiColor Smart Module and mobile application at the heart of the new Color Changing Lighting System allow users to program custom color sequences and transitions, set sequence timing and daily scheduling and unlock all RGB options on any Apple or Android mobile device.

- Every Color Changing Colorfalls includes Single-zone InfiColor Smart Module
- Smart Module is wirelessly controlled via InfiColor App to unlock the full potential of Color Changing Lights, no remote necessary
- Upgrade any Atlantic Color Changing Lighting or Color Changing Colorfalls to the InfiColor System using the adapter included with every Colorfalls

The Bluetooth® InfiColor App makes custom colors, sequences, transitions, timing and daily scheduling of your Atlantic Color Changing Lighting or Color Changing Colorfalls accessible on any Apple and Android mobile device.

- Choose any color visually or create a custom color with RGB sliders
- Combine and save custom color sequences as Favorites
- Assign one of five transitions and adjust the speed of any Favorite
- Adjust brightness of sequences and solid colors if desired
- InfiColor App available on all Apple and Android devices



DID YOU KNOW?



All Color Changing Colorfalls are **FULLY COMPATIBLE** with all Atlantic Color Changing Lighting and the new InfiColor Smart Module and App. How? All newer lighting components include a Plug Adapter for use with previous Color Changing Modules and wiring. The new InfiColor Smart Module includes a Pigtail Adapter for backwards compatibility with previous Color Changing Colorfalls and SOL Color Changing lighting. Page 98-107

316 STAINLESS STEEL SPILLWAYS



SS12-316

SS24-316

SS36-316

- 316 Stainless Steel Spillways enhance any vertical wall in pools, hardscapes and wherever chlorine is used as a disinfecting agent

- Modular design and convenient 4-inch height make Spillways ideal for garden wall block construction

- Readily adaptable to any vertical wall installation without cutting

- Built of heavy-gauge 316 stainless steel for durability under the harshest conditions
- Structural enclosure supports 80 lbs. per linear foot, for incorporation into masonry walls without lintels
- Non-clogging weir reduces maintenance in open basin applications

| MODEL | ITEM | LIST | DESCRIPTION | FLOW RATE | PROJECTION* | INLET | DIMENSIONS | WARRANTY |
|----------|-------|----------|----------------------------------|-----------|------------------------------|----------|-------------------|----------|
| SS12-316 | 73859 | \$325.99 | 12" 316 Stainless Steel Spillway | 1,200 gph | 9" - 10" at 18"H & 1,200 gph | 1½" FIPT | 12"W x 8½"D x 4"H | 3-year |
| SS24-316 | 73861 | \$474.99 | 24" 316 Stainless Steel Spillway | 2,400 gph | 9" - 10" at 18"H & 2,400 gph | 1½" FIPT | 24"W x 8½"D x 4"H | 3-year |
| SS36-316 | 73863 | \$691.99 | 36" 316 Stainless Steel Spillway | 3,600 gph | 9" - 10" at 18"H & 3,600 gph | 1½" FIPT | 36"W x 8½"D x 4"H | 3-year |

* Projection is measured from the face of the wall the Spillway is installed in

TECH TIP

316 Stainless Steel Spillways were specifically designed for use with chlorinated water. 316 stainless is much more resistant to corrosion than 304 stainless steel. Atlantic's new 316 Stainless Steel Spillways feature an integrated grounding lug for use in bonded systems.



304 SPILLWAYS

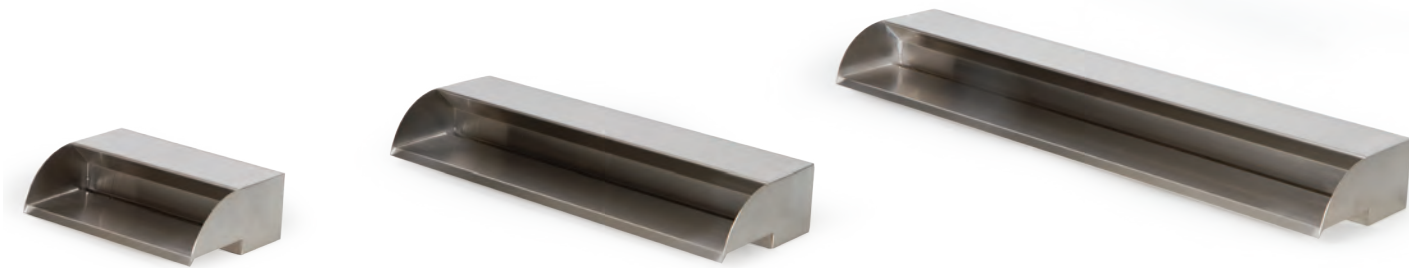

SS12

SS24

SS36

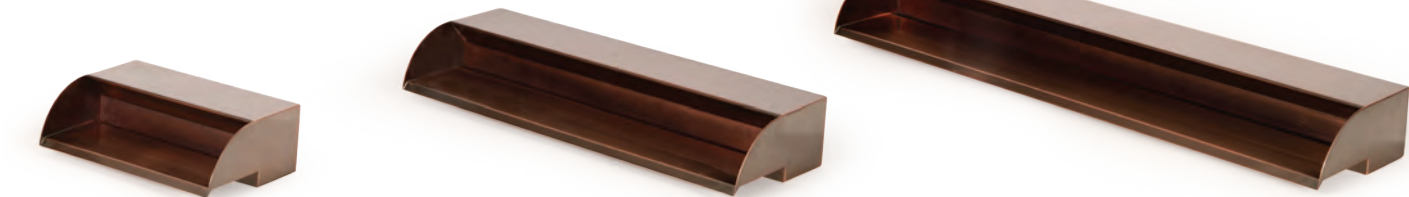

CS12

CS24

CS36

- 304 Stainless Steel Spillways provide an enticing and durable focal point for fresh water applications in the hardscape
- Atlantic's copper finish and brushed stainless Spillways feature heavy-gauge construction for ageless durability
- Spillways replace 4-inch wall blocks for easy and convenient installation in standard wall block construction without cutting

- Lively, energetic water flow enhances any vertical wall installation
- Load bearing body design supports 80 lbs. per linear foot for trouble free installations
- Non-clogging weir reduces maintenance in open basin applications

| MODEL | ITEM | LIST | DESCRIPTION | FLOW RATE | PROJECTION* | INLET | DIMENSIONS | WARRANTY |
|-------|-------|----------|----------------------------------|-----------|------------------------------|----------|-------------------|----------|
| SS12 | 73858 | \$230.99 | 12" 304 Stainless Steel Spillway | 1,200 gph | 9" - 10" at 18"H & 1,200 gph | 1½" FIPT | 12"W x 8½"D x 4"H | 3-year |
| CS12 | 73855 | \$285.99 | 12" 304 Copper Finish Spillway | 1,200 gph | 9" - 10" at 18"H & 1,200 gph | 1½" FIPT | 12"W x 8½"D x 4"H | 3-year |
| SS24 | 73860 | \$338.99 | 24" 304 Stainless Steel Spillway | 2,400 gph | 9" - 10" at 18"H & 2,400 gph | 1½" FIPT | 24"W x 8½"D x 4"H | 3-year |
| CS24 | 73856 | \$428.99 | 24" 304 Copper Finish Spillway | 2,400 gph | 9" - 10" at 18"H & 2,400 gph | 1½" FIPT | 24"W x 8½"D x 4"H | 3-year |
| SS36 | 73862 | \$474.99 | 36" 304 Stainless Steel Spillway | 3,600 gph | 9" - 10" at 18"H & 3,600 gph | 1½" FIPT | 36"W x 8½"D x 4"H | 3-year |
| CS36 | 73857 | \$577.99 | 36" 304 Copper Finish Spillway | 3,600 gph | 9" - 10" at 18"H & 3,600 gph | 1½" FIPT | 36"W x 8½"D x 4"H | 3-year |

* Projection is measured from the face of the wall the Spillway is installed in



WATERWALL SPILLWAYS

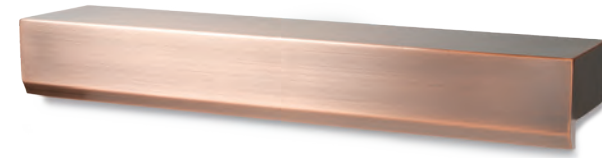

SWS24-316

- Unique back-angled spout directs water downwards and onto wall below plumbing connection, to eliminate leaks, unwanted humidity and splash
- Revolutionary concept of spillway as a decorative focal point eliminates the need for valances
- Heavy-gauge 316 stainless steel construction ensures durability under even the harshest conditions

CWS24-316

- Bottom inlet accommodates wood-framed walls with masonry façades up to 1½" thick
- For masonry walls, cut channel in block below water wall to accommodate plumbing
- 1½" female threaded inlet and center rear bonding lug facilitate hidden in-wall plumbing connections

| MODEL | ITEM | LIST | DESCRIPTION | FLOW RATE | INLET | DIMENSIONS | WARRANTY |
|-----------|-------|----------|--|--|----------|--------------------|----------|
| SWS24-316 | 73877 | \$338.99 | 24" Stainless Steel WaterWall Spillway | Smooth Surfaces - 750-1500 gph Rough Surfaces - 1500-3000 gph | 1½" FIPT | 24"W x 5¼"D x 3½"H | 3-year |
| CWS24-316 | 73876 | \$428.99 | 24" Copper Finish WaterWall Spillway | Smooth Surfaces - 750-1500 gph Rough Surfaces - 1500-3000 gph | 1½" FIPT | 24"W x 5¼"D x 3½"H | 3-year |

DID YOU KNOW?

A new concept in water wall design, Atlantic's WaterWall Spillways eliminate the need for valances with an attractive stainless steel or copper finish that can be left visible, simplifying installation. Modular vertical spillways create water walls and weeping walls of any width in 24-inch increments, with seamless water flow between units.



SPLASH RINGS



CFSR12

CFSR24

CFSR36

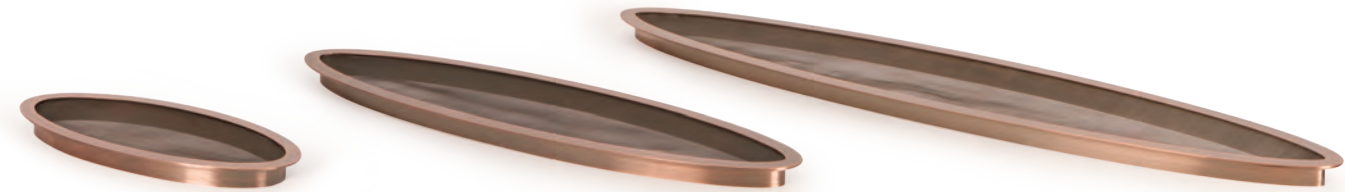

CFCR12

CFCR24

CFCR36

- Splash control is critical in small recirculating systems with little water volume
- Atlantic Splash Rings eliminate splash and reduce evaporation, prolonging time between fill ups
- Installed on the top of the basin, Splash Rings add a finished, architectural accent to Colorfalls, Wall Spout and Spillway displays

- Surround Splash Rings with decorative gravel for a finished look
- 304 stainless steel mesh and ¾" stainless banding deliver years of service

| MODEL | ITEM | LIST | DESCRIPTION | FOR USE WITH | DIMENSIONS | WARRANTY |
|--------|-------|----------|---|--------------|--------------------|----------|
| CFSR12 | 74973 | \$184.99 | Stainless Steel Splash Ring for 12" Spillways | CFBASIN12 | 16"W x 8"D x 1½"H | 3-year |
| CFCR12 | 73864 | \$228.99 | Copper Finish Splash Ring for 12" Spillways | CFBASIN12 | 16"W x 8"D x 1½"H | 3-year |
| CFSR24 | 74226 | \$265.99 | Stainless Steel Splash Ring for 24" Spillways | CFBASIN24 | 28"W x 8"D x 1½"H | 3-year |
| CFCR24 | 73865 | \$331.99 | Copper Finish Splash Ring for 24" Spillways | CFBASIN24 | 28"W x 8"D x 1½"H | 3-year |
| CFSR36 | 74974 | \$338.99 | Stainless Steel Splash Ring for 36" Spillways | CFBASIN36 | 40"W x 8½"D x 1½"H | 3-year |
| CFCR36 | 73866 | \$424.99 | Copper Finish Splash Ring for 36" Spillways | CFBASIN36 | 40"W x 8½"D x 1½"H | 3-year |

PF POND-FREE

Atlantic's Pond-free System makes below ground reservoir construction simpler, easier and more reliable. Sturdy Pump Vaults, Extensions and Eco-Blox create underground reservoirs that are stronger and safer than ever before. Above ground, FastFalls lead the industry with unmatched weight capacities and virtually leak-proof design. Innovative components make Atlantic's family of Pond-free products the best ever built.

- » Strongest water matrix blocks, vaults and spillways in the industry for longevity and peace of mind
- » Modular reservoir system creates water features of any size for the greatest versatility
- » Kits with pre-matched components take the guesswork out of specifying water features
- » FastFalls spillways with rear liner attachment eliminate leaks due to settling
- » Pump Vaults accommodate multiple pumps, plumbing sizes and accessories
- » Eco-Blox interlock to create stacked assemblies for easier installation and deeper reservoirs



POND-FREE SYSTEM

- 1 FastFalls "inside the liner" design and reinforced spillway lip prevents leaks and retains rock, gravel, soil or mulch to help blend seamlessly with the surrounding landscape.
- 2 One-piece liner flange and molded inserts ensure a watertight liner attachment every time.
- 3 Molded support cones and internal baffles give the FastFalls incredible strength and diffuse the water, ensuring consistent flow across the spillway.
- 4 Heavy-duty, one-piece Pump Vaults offer all the strength and versatility you need, allow for large flow rates and will not bow, bend or break, even under the most extreme conditions.



- 5 Pump Vault Extensions add the height of one Eco-Blox for larger, deeper basins and carry the same strength and durability as Atlantic Pump Vaults.
- 6 Eco-Blox are modular, load-bearing blocks that hold 31.5 gallons of water each and with 96% void space, allow large volumes of water to be stored easily and economically.
- 7 Slide locks allow for quick, tool-free assembly of Eco-Blox that is also more secure and stable than peg-style connections used by the competition.
- 8 Eco-Blox are extremely strong, able to support 7.5 tons and are AASHTO HS-20 compliant for commercial applications.

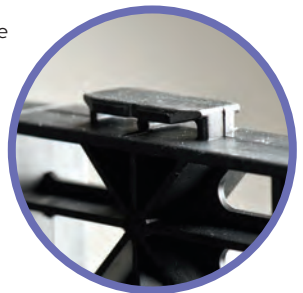
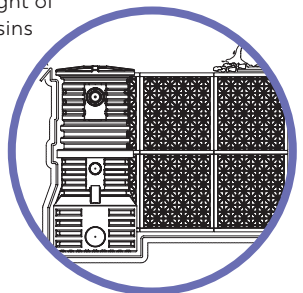



ECO-BLOX



Extra heavy-duty crossbars for improved point load strength

- Water matrix blocks installed in lined excavations create weight-bearing underground water storage reservoirs
- Atlantic's Eco-Blox are the strongest water matrix blocks available, capable of supporting over seven tons of distributed load
- With 96% void space, Atlantic's Eco-Blox hold more water in a smaller volume, reducing the overall size of the basin
- Save labor, time and money on Pond-free, rainwater harvesting and storm water management installations versus gravel-filled reservoirs
- Eco-Blox lock together quickly and securely, easily supporting landscaping, pavers, gravel or sod for great design versatility
- Arrange modular blocks in any configuration and any number of levels to accommodate almost any basin
- Excellent for bog construction to create settling chambers below natural plantings of active bog filters

| MODEL | ITEM | LIST | DESCRIPTION | DIMENSIONS | CAPACITY | APPLICATIONS | WARRANTY |
|-----------|-------|------------|---|---------------------|-------------|--|----------|
| ECOBLOX | 74234 | \$59.99 | Eco-Blox Water Matrix (Boxed) | 27"L x 16"W x 17½"H | 31½ gallons | Pond-free / Fountain / Rain Harvesting | 1-year |
| ECOBLOX-P | 74268 | \$3,141.99 | Full Pallet of Eco-Blox (Unboxed) | --- | --- | Pond-free / Fountain / Rain Harvesting | 1-year |
| ECOBLOXSM | 74270 | \$19.99 | Eco-Blox Small Panels (Pack of 4 - unboxed) | 16½"L x 15"W x ¾"H | --- | Pond-free / Fountain / Rain Harvesting | 1-year |
| ECOBLOXLG | 74269 | \$35.99 | Eco-Blox Large Panels (Pack of 4 - unboxed) | 27"L x 16"W x ¾"H | --- | Pond-free / Fountain / Rain Harvesting | 1-year |

DID YOU KNOW?

Eco-Blox have been tested and approved for compliance with the American Association of State Highway and Traffic Officials AASHTO HS-20 standard with a minimum safety factor of 200% for every condition and depth calculated. Independent testing in a machine press demonstrated Eco-Blox supporting over 15,000 lbs. before failure. Testing results available upon request.



POND-FREE KITS

- Kits come complete, right down to PVC glue, thread sealant and fittings, to eliminate guesswork and material runs, saving you time and money
- Included LED lighting extends the enjoyment of the water feature into the evening
- Vaults and Spillways are matched to energy efficient pumps to keep operating costs low
- Properly equipped for optimum streambed length and reservoir capacity to ensure your water feature works as designed

SMALL POND-FREE KIT

- Triton Check Valve
- Heavy-duty Underlayment
- Complete installation kit including fittings, thread sealant, PVC glue and 12oz. FallsFoam



| MODEL | ITEM | LIST | LINER SIZE | FASTFALLS | PUMP VAULT | ECO-BLOX | PUMP | TUBING | BASIN SIZE | STREAMBED SIZE |
|----------|-------|----------|------------|-----------|------------|----------|--------|-----------|-----------------|------------------|
| PK1716PL | 74250 | \$999.99 | 10' x 15' | SP1600 | PV1700 | 2 | TT3000 | 1½" x 25' | 48" x 30" x 18" | 16" - 24"W x 6'L |

LARGE POND-FREE KITS

- Triton Check Valve
- Heavy-duty Underlayment
- (2) WWCS2 pond lights and WW30X4 Transformer
- AF1000 Auto Fill
- Complete installation kit including fittings, thread sealant, PVC glue and (2) 12oz. FallsFoam

* An additional two lights may be added with no additional hardware necessary



| MODEL | ITEM | LIST | LINER SIZE | FASTFALLS | PUMP VAULT | ECO-BLOX | PUMP | TUBING | BASIN SIZE | STREAMBED SIZE |
|----------|-------|------------|------------|-----------|------------|----------|--------|----------|-----------------|-------------------|
| PK1819PL | 74249 | \$1,466.99 | 10' x 15' | SP1900 | PV1800 | 3 | TT4000 | 2" x 25' | 54" x 32" x 18" | 19" - 24"W x 6'L |
| PK1826PL | 74251 | \$1,722.99 | 10' x 20' | SP2600 | PV1800 | 5 | TT5000 | 2" x 25' | 54" x 48" x 18" | 26" - 32"W x 10'L |

PF

CAD

3D



PUMP VAULTS



PV1700



PV1800



PV2300



PV18EXT



PV23EXT

- Pump Vaults house and protect the pumps and plumbing of underground water storage and circulation systems
- Vaults are rotomolded of virtually indestructible polyethylene for long, worry-free service
- Sized to accommodate multiple pumps, Vaults also house Ionizers, Check Valves and Auto Fill Valves
- Tight fitting covers and generous openings provide easy, secure access to pump and plumbing and accessories

- Pump Vault Extensions increase the height of the Vault in deeper, larger basins, with each extension the height of one Eco-Blox
- Flat panels and multiple cut lines allow the use of 1½" through 6" pipe, auto fills, overflows and custom plumbing options
- Easily accommodate any project from the largest waterfalls to rainwater cisterns to upflow and downflow bogs

| MODEL | ITEM | LIST | DIMENSIONS | MAX PUMP FLOW | OPENING | EXTENSION | DISCHARGE | WARRANTY |
|---------|-------|----------|---------------------|---------------|---------|-----------|-----------------------|----------|
| PV1700 | 74235 | \$218.99 | 17"W x 12"D x 22½"H | 3,900 gph | 10" | --- | 1½" & 2" step outlets | Lifetime |
| PV1800 | 74252 | \$261.99 | 18"W x 24"H | 10,000 gph | 14" | --- | 2" cut lines | Lifetime |
| PV2300 | 74236 | \$457.99 | 23"W x 30"H | 15,000 gph | 18" | --- | 2" & 3" cut lines | Lifetime |
| PV18EXT | 74253 | \$179.99 | 16½"W x 19½"H | --- | 14" | 17" | 2" & 3" cut lines | Lifetime |
| PV23EXT | 74237 | \$210.99 | 21½"W x 19½"H | --- | 18" | 17" | 2" & 3" cut lines | Lifetime |

ROCK LIDS

Atlantic's realistic Rock Lids are molded from real stones. The sturdy fiberglass construction, authentic textures and incredibly real finishes set these Rock Lids apart from plastic covers. Four regional colors complement every application perfectly. No one will ever know it's not real!



RL30G Great Lakes
RL30D Desert (shown)
RL30M Mountain
RL30S Southern

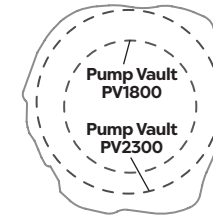

RL30 Footprint

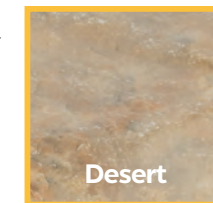

Desert



Southern

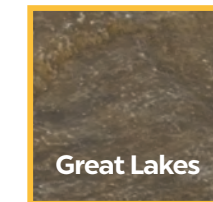

Great Lakes

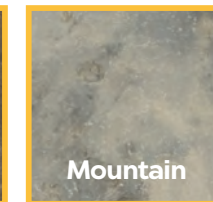

Mountain

COLORS SHOWN MAY VARY FROM ACTUAL PRODUCT

| MODEL | ITEM | LIST | DIMENSIONS | MATCH TO PUMP VAULT | WARRANTY |
|-------|-------|----------|-------------------|---------------------|----------|
| RL30D | 74005 | \$144.99 | 24"L x 24"W x 5"H | PV1800 & PV2300 | 1-year |
| RL30G | 74006 | | | | |
| RL30M | 74007 | | | | |
| RL30S | 74008 | | | | |



back

PV1700 FEATURES:

1. Inset lid keeps gravel from falling into the vault.
2. Cut-off step outlets for 1½" and 2" pipe provided on both sides of the vault.
3. Flat front panel installs tight against Eco-Blox for a compact basin.
4. Recessed pockets accept Triton 3-Way Diverter for use in the Eco-Rise System. (see page 11)
5. Flat panel for 1½" pipe for use with the Eco-Rise System.

PV1800 / PV2300 FEATURES:

1. Large diameter housing provides better access to pump and plumbing.
2. Each Pump Vault Extension allows for an additional layer of Eco-Blox.
3. Molded cut lines facilitate plumbing the pump discharge.
4. Flat panels accommodate Auto Fill and custom plumbing options.
5. Heavy-duty ribbed design eliminates warping and crushing.
6. Molded cut lines for multiple sizes of SDR35 pipe make installing bogs simple.



TECH TIP

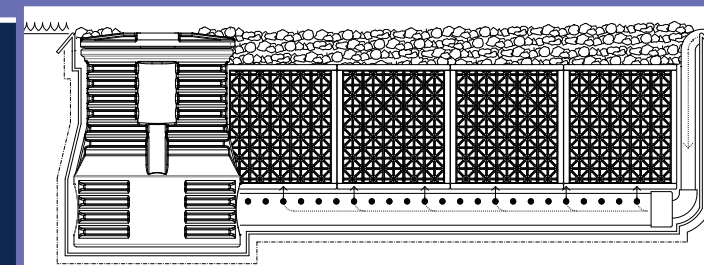

Atlantic's Eco-Blox and Pump Vaults make excellent, easy to maintain bog filters. With a perforated pipe under Eco-Blox, the Pump Vault acts as a cleanout for upflow bogs of any size. Pond water pumped into the bottom of the Eco-Blox reservoir sheds velocity which causes sediment to settle out. Plants set in a thin layer of gravel on top of the Eco-Blox remove fine solids and nitrates. Simply flush the chamber from above into the Pump Vault to remove sediment.



FASTFALLS



SP1600

SP1900

SP2600

SP3800

- Spillway boxes diffuse incoming water flow to create the starting point of Pond-free streams and falls
- Atlantic FastFalls are designed to make plumbing the top of the waterfall as easy as possible
- Innovative rear liner attachment simplifies installation and eliminates leakage due to settling

- Crush-proof design with internal baffles stabilized by support cones carries the weight of the largest rock and stone
- Reinforced spillway lip retains rock, gravel, mulch or soil and can be planted to blend seamlessly into the surrounding landscape
- FastFalls includes installation kit, male thread adapter and one-piece liner flange

| MODEL | ITEM | LIST | DIMENSIONS | WATERFALL WIDTH | MAX PUMP FLOW | INLET | WARRANTY |
|--------|-------|----------|----------------------|-----------------|---------------|----------|----------|
| SP1600 | 74271 | \$149.99 | 16½"W x 9½"D x 7¼"H | 16" | 3,000 gph | 1½" FIPT | Lifetime |
| SP1900 | 74227 | \$216.99 | 20½"W x 17"D x 10¼"H | 19" | 4,000 gph | 2" FIPT | Lifetime |
| SP2600 | 74228 | \$287.99 | 27½"W x 17"D x 10¼"H | 26" | 6,000 gph | 2" FIPT | Lifetime |
| SP3800 | 74229 | \$385.99 | 39½"W x 17"D x 10¼"H | 38" | 9,000 gph | 3" FIPT | Lifetime |

SP1600 FEATURES:



SP1600 shown

1. Internal baffle diffuses the water for an even flow across the spillway.
2. Raised front radius retains natural camouflage.
3. One-piece design eliminates any chance of leaks due to 'over pumping'.
4. Pre-installed 1½" Spinweld® fitting simplifies plumbing connection.
5. One-piece liner flange and molded inserts ensure a secure liner attachment.

SP1900 / SP2600 / SP3800 FEATURES:

1. Molded support cones give the FastFalls incredible strength and help diffuse the water flow.
2. Two internal baffles slow down the water's velocity and ensure even water distribution across the spillway.
3. Raised front radius holds back any loose gravel, soil or mulch used to camouflage the top of the unit.
4. FastFalls are completely sealed except for the spillway opening. This design eliminates any chance of leakage due to 'over pumping'.
5. Molded gussets support the spillway lip.
6. FastFalls come with an installed 2" or 3" FIPT Spinweld® fitting.
7. One-piece liner flange and molded inserts ensure a watertight liner attachment every time.



SP2600 shown

back

DID YOU KNOW?

Did you know there is a FastFalls hiding in this photo? Although the FastFalls can support the heaviest rock and stone, it was also designed to retain soil, gravel and mulch perfectly. For the most natural looking camouflage possible, plant ground covers or low growing perennials directly into the pockets on top of the FastFalls to blend the FastFalls seamlessly with the surrounding landscape.



DID YOU KNOW?

When we say you don't have to worry about crushing, cracking or breaking your FastFalls, we mean it! Set your large boulders right on top to camouflage these spillways without a second thought - we test them with a 33,000 lb. Caterpillar 928F Wheel Loader. Now, that's strong!



WATER GARDEN

Atlantic's Water Garden System offers a complete solution for every pond builder. Full-featured Skimmers and FilterFalls remove floating debris, fish wastes and suspended solids with minimal maintenance. In-pond and pressure filters clear and clean smaller ponds. Advanced ScreenMatic² and ProfiClear filters handle the heaviest fish loads and clean themselves. Select custom accessories or choose a Pond Kit that comes with all the equipment, liner and plumbing you'll need to complete any project.

- » Full range of Skimmers, FilterFalls and Filters for every size water garden
- » Crush-proof Skimmers and FilterFalls with lifetime warranties eliminate concerns of warping and deformation in the ground
- » Multiple filtration options and styles accommodate any fish stocking levels
- » Pond Kits containing everything needed for a complete installation save you time and money
- » A complete line of accessories to complement and enhance your water garden allows for full customization



1 Skimmers feature Super Flow weir doors, stainless steel hardware and a heavy-duty rotomolded shell for the ultimate in durability backed by a lifetime warranty.

2 Skimmers feature large stainless steel-framed nets and stainless/nylon filter brush panels or Matala matting for excellent pre-filtration and accept Matala cartridge upgrades.

3 Large pump chambers capable of housing multiple pumps provide the versatility to improve energy efficiency by using two smaller pumps instead of one large one.

4 Optional installation accessories such as the Triton Ionizer, Bottom Drain Kit and Auto Fill Kit allow you to keep your pond clean while reducing maintenance at the same time.



5 Atlantic's flexible PVC piping, geotextile underlayment and EPDM liner are all proudly made in the United States to the highest quality standards.

6 Heavy-duty rotomolded polyethylene FilterFalls feature stainless steel hardware, molded inserts and solid lips for watertight liner attachment and lifelong durability.

7 Sturdy support bars and top grates support the weight of natural rock camouflage and prevent crushing or warping from the surrounding soil.

8 Oversized interior volumes provide tremendous filtration capacity out of the box, expandable with any combination of Matala Mat Kits, Bio-Balls, Bio-Rocks and Bio-Tech media for custom filtration options.

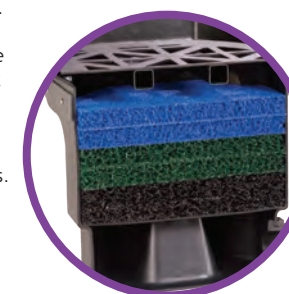



SKIMMERS



PS3000



PS3900



PS4600



PS7000



PS15000

- Skimmers house and protect your pump and plumbing while clearing surface debris from the pond
- Atlantic's Pond Skimmers feature more size and filtration options and greater strength and versatility
- All Skimmers excluding PS3000 accept two pumps for increased flow, lower operating costs and multiple spillway options
- Multiple filtration options including net, mats and brushes let you customize to fit every water garden

- Reinforced structures eliminate warping, deformation and callbacks
- Faceplate hardware is black anodized stainless steel for maximum concealment and longevity
- Multiple plumbing, check valve and ionizer options make these Skimmers the most versatile on the market
- PS3000 Satellite Skimmer plumbs to a larger Skimmer (PS7000/PS15000) to draw water from hard to reach areas using an AquaMax Eco Premium Pump, installed inside the liner

| MODEL | ITEM | LIST | WEIR WIDTH | INTERNAL WATER DEPTH | DIMENSIONS | MAX PUMP FLOW | SQ. FT. RATING | FILTERING | MATCH TO | WARRANTY |
|---------|-------|----------|------------|----------------------|-----------------------|---------------|----------------|------------------|------------------|----------------------|
| PS3000 | 74038 | \$247.99 | 6" | 21" | 13"W x 13"D x 25"H | 3,000 gph | 200 | Net | PS7000 / PS15000 | Lifetime (enclosure) |
| PS3900 | 74039 | \$302.99 | 6" | 14½" | 17¾"W x 19½"D x 19½"H | 3,900 gph | 200 | Net, Matala mat | BF1600 | Lifetime (enclosure) |
| PS4600 | 74040 | \$437.99 | 6" | 15½" | 19½"W x 26"D x 22"H | 4,000 gph | 400 | Net, Brush panel | BF1900 | Lifetime (enclosure) |
| PS7000 | 74041 | \$555.99 | 9" | 17½" | 25"W x 30"D x 24"H | 7,000 gph | 900 | Net, Brush panel | BF2600 | Lifetime (enclosure) |
| PS15000 | 74037 | \$812.99 | 14" | 24½" | 28"W x 33"D x 31"H | 15,000 gph | 1400 | Net, Brush panel | BF3800 | Lifetime (enclosure) |

PS3900 FEATURES:

1. Sturdy removable lid supports natural rock camouflage and foot traffic.
2. Support bar for added strength.
3. Stainless steel-framed trap net and Matala filter mat provide mechanical filtration.
4. Designed to enhance structural rigidity.
5. Rolled upper rim provides clean lines and incredible strength.
6. Cut-off step outlets for 1½" and 2" pipe provided on both sides of the skimmer.
7. Super Flow weir door to maximize skimming efficiency.
8. Labeled drill points for the installation of Auto Fill and overflow. (not shown)



PS3900 shown

PS4600/PS7000 / PS15000 FEATURES:

1. Sturdy removable top lid supports natural rock camouflage and foot traffic.
2. Heavy-duty brush panel provides maximum surface area for mechanical filtration.
3. Heavy-duty stainless steel framed trap net for catching large debris.
4. Rolled upper rim provides clean lines and great strength.
5. Super Flow weir door to maximize skimming efficiency.
6. Ribbed design enhances structural rigidity and strength.



PS7000 shown

ROCK LIDS



RL30D Desert (shown)
RL30G Great Lakes



RL30M Mountain
RL30S Southern



RL40D Desert
RL40G Great Lakes

RL40M Mountain (shown)
RL40S Southern

RL70D Desert
RL70G Great Lakes

RL70M Mountain
RL70S Southern (shown)

- Rock Lids cover Skimmers completely to attractively conceal them in the water garden
- Molded from real stones, the sturdy fiberglass construction, authentic textures and incredibly real finishes set these Rock Lids apart

- Three sizes and four regional colors ensure the perfect fit for every application
- Rock Lids can also be used to hide and protect Pump Vaults, FilterFalls and other equipment

| MODEL | ITEM | LIST | DIMENSIONS | MATCH TO SKIMMER | WARRANTY |
|-------|-------|----------|--------------------|------------------|----------|
| RL30D | 74005 | \$144.99 | 24"L x 24"W x 5"H | PS3900 | 1-year |
| RL30G | 74006 | | | | |
| RL30M | 74007 | | | | |
| RL30S | 74008 | \$181.99 | 34"L x 24"W x 5"H | PS4600 | 1-year |
| RL40D | 74009 | | | | |
| RL40G | 74010 | | | | |
| RL40M | 74011 | | | | |
| RL40S | 74012 | \$235.99 | 40"L x 36"W x 10"H | PS7000 / PS15000 | 1-year |
| RL70D | 74013 | | | | |
| RL70G | 74014 | | | | |
| RL70M | 74015 | | | | |
| RL70S | 74016 | | | | |

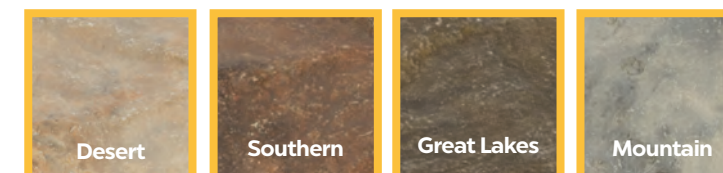

COLOR REPRESENTATIONS SHOWN MAY VARY ON ACTUAL PRODUCT. GREAT LAKES PICTURED ON TOP OF PAGE 41

FILTERFALLS



BF1600

BF1900

BF2600



BF3800

- Biomechanical filters remove suspended solids, convert toxic ammonia and nitrites to harmless nitrates and aerate the pond
- Atlantic's FilterFalls are designed to be able to expand filter capacity as ponds age and fish grow
- Efficient removal of toxins and floating particles from the water column improves water quality and clarity
- Oversized chamber contains more media material to start with, accepts additional filtration when needed and accommodates more choices of filtration media
- Overhanging weir with drip edge eliminates leaking due to silicone seal failure
- Multiple bulkhead locations allow maximum versatility in plumbing FilterFalls
- Reinforced body prevents warping and deformation for years of worry-free service
- Support bars accommodate heavier stone and gravel for ease in camouflaging
- FilterFalls includes installation kit, male thread adapter and one-piece liner flange

| MODEL | ITEM | LIST | WATERFALL WIDTH | DIMENSIONS | PUMP FLOW RANGE | BULKHEAD | POND VOLUME | MATCH TO | WARRANTY |
|--------|-------|----------|-----------------|-----------------------|-------------------|----------|---------------------|----------|----------------------|
| BF1600 | 73934 | \$277.99 | 16" | 21½"W x 19½"D x 17¼"H | 1,000 - 3,900 gph | 1½" | up to 1,250 gallons | PS3900 | Lifetime (enclosure) |
| BF1900 | 73935 | \$407.99 | 19" | 28"W x 25"D x 21½"H | 2,500 - 4,000 gph | 2" | up to 2,000 gallons | PS4600 | Lifetime (enclosure) |
| BF2600 | 73936 | \$496.99 | 26" | 34½"W x 25"D x 23"H | 4,000 - 6,000 gph | 2" | up to 4,000 gallons | PS7000 | Lifetime (enclosure) |
| BF3800 | 73937 | \$790.99 | 38" | 46½"W x 30"D x 23"H | 6,000 - 8,000 gph | 3" | up to 8,000 gallons | PS15000 | Lifetime (enclosure) |

BF1600 FEATURES:



1. Sturdy top grate and support bar allow natural rock camouflage.
2. Media Bag for Bio-Tech Media / Bio-Balls / Bio-Rocks (sold separately) provide maximum surface area for beneficial bacteria.
3. Dual Bio-Tech filter mats supply both mechanical and biological filtration.
4. Sturdy bottom grate supports filter media.
5. Rolled upper rim provides clean lines with great strength.
6. One-piece liner attachment flange.
7. Heavy-duty 1½" FIPT bulkhead.

BF1600 shown

BF1900 / BF2600 / BF3800 FEATURES:

1. Heavy-duty removable top grate supports rock camouflage.
2. Support bars add stability and reinforce top grate.
3. Media Bag for Bio-Tech Media / Bio-Balls / Bio-Rocks (sold separately) provide maximum surface area for beneficial bacteria.
4. Dual Bio-Tech filter mats support both mechanical and biological filtration.
5. Sturdy bottom grate supports filter media.
6. Rolled upper rim provides clean lines with great strength.
7. 2" or 3" heavy-duty FIPT bulkhead for high flow rates.
8. Bottom chamber accepts bulkheads on all sides while bottom cones inside reduce surface area for back flushing.
9. One-piece liner flange allows easy, leak-free attachment of FilterFalls to pond liner.
10. Solid lip and molded inserts ensure a watertight liner attachment every time.

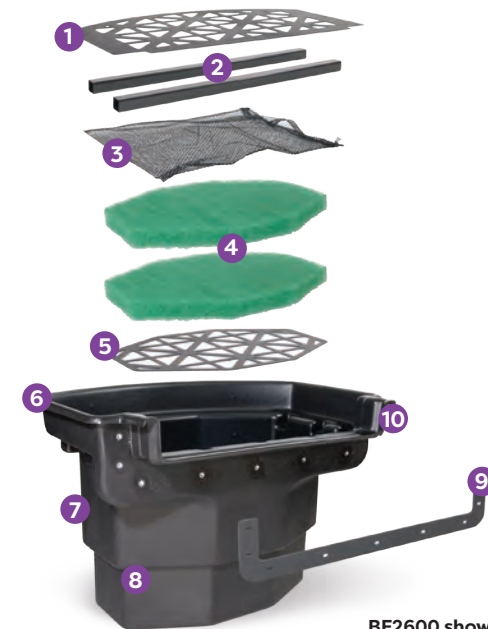

BF2600 shown



DID YOU KNOW?

Atlantic's custom cut Matala Filter Kits add tremendous surface area for biological activity, with 62 square feet of surface area available for bacterial colonization in every square foot of black mat, 96 square feet for the green and 124 square feet for the blue. Each Matala Kit adds over 300 square feet of biological filtration to your pond!



WATER GARDEN KITS

- Atlantic Pond Kits save you time and money by avoiding costly mismatching and multiple trips to the store
- Skimmer, FilterFalls, pump and accessories are designed to work together to eliminate any guesswork
- Energy efficient pumps keep operating costs under control
- Medium, Large and Extra Large Kits include LED lighting to extend the enjoyment of the water feature into the evening

SMALL WATER GARDEN KITS

- Triton Check Valve
- Heavy-duty underlayment
- AF1000 Auto Fill
- Complete installation kit includes fittings, thread sealant, PVC glue and 12oz. FallsFoam



| MODEL | ITEM | LIST | LINER SIZE | FILTERFALLS | SKIMMER | PUMP | TUBING | POND SIZE* |
|----------|-------|------------|------------|-------------|---------|--------|-----------|--------------------|
| PK161015 | 74238 | \$1,061.99 | 10' x 15' | BF1600 | PS3900 | TT2000 | 1½" x 25' | 5'L x 10'W x 18"D |
| PK161515 | 74239 | \$1,184.99 | 15' x 15' | BF1600 | PS3900 | TT3000 | 1½" x 25' | 10'L x 10'W x 18"D |

MEDIUM WATER GARDEN KITS

- Triton Check Valve
- Heavy-duty underlayment
- AF1000 Auto Fill
- (2) WWCS2 pond lights and WW30X4 transformer and splitter*
- Complete installation kit includes fittings, thread sealant, PVC glue and (2) 12oz. FallsFoam



* An additional two lights may be added with no additional hardware necessary

| MODEL | ITEM | LIST | LINER SIZE | FILTERFALLS | SKIMMER | PUMP | TUBING | POND SIZE* |
|----------|-------|------------|------------|-------------|---------|--------|----------|--------------------|
| PK191515 | 74240 | \$1,694.99 | 15' x 15' | BF1900 | PS4600 | TT4000 | 2" x 25' | 10'L x 10'W x 18"D |
| PK191520 | 74241 | \$1,862.99 | 15' x 20' | BF1900 | PS4600 | TT5000 | 2" x 25' | 10'L x 15'W x 18"D |

LARGE WATER GARDEN KITS

- Triton Check Valve
- Heavy-duty underlayment
- AF1000 Auto Fill
- (2) WWCS2 pond lights and WW30X4 transformer and splitter*
- Complete installation kit includes fittings, thread sealant, PVC glue and (2) 12oz. FallsFoam



* An additional two lights may be added with no additional hardware necessary

| MODEL | ITEM | LIST | LINER SIZE | FILTERFALLS | SKIMMER | PUMP | TUBING | POND SIZE* |
|----------|-------|------------|------------|-------------|---------|--------|----------|--------------------|
| PK261520 | 74242 | \$1,891.99 | 15' x 20' | BF2600 | PS7000 | TT5000 | 2" x 25' | 10'L x 15'W x 18"D |
| PK262020 | 74243 | \$2,044.99 | 20' x 20' | BF2600 | PS7000 | TT6000 | 2" x 25' | 15'L x 15'W x 18"D |

EXTRA LARGE WATER GARDEN KITS

- AWGCV30 Check Valve
- Heavy-duty underlayment
- AF1000 Auto Fill
- (2) WWCS2 pond lights and WW30X4 transformer and splitter*
- Complete installation kit including fittings, thread sealant, PVC glue and (2) 12oz. FallsFoam
- Extra Large Pond Kits measure 42"W x 36"H x 48"D and are supplied on a pallet



* An additional two lights may be added with no additional hardware necessary

| MODEL | ITEM | LIST | LINER SIZE | FILTERFALLS | SKIMMER | PUMP | TUBING | POND SIZE |
|----------|-------|------------|------------|-------------|---------|--------|----------|--------------------|
| PK382025 | 74244 | \$3,241.99 | 20' x 25' | BF3800 | PS15000 | TT9000 | 3" x 50' | 15'L x 20'W x 18"D |
| PK382530 | 74245 | \$3,784.99 | 25' x 30' | BF3800 | PS15000 | A-31 | 3" x 50' | 20'L x 25'W x 18"D |

STREAMBED LINER

Don't forget streambed liner! When ordering your Pond Kit simply add liner, tubing and a coupling for a stream that will really accent your pond

- For your Small Pond Kit order an 8' x 10' boxed liner, 1½" x 25' roll of tubing and 1½" coupling to add a six- to eight-foot stream to your pond
- For Medium and Large Pond Kits add a 10' x 15' boxed liner, 2" x 25' roll of tubing and 2" coupling for streams up to 13 feet long
- For Extra Large Pond Kits, add a 15' x 20' boxed liner, 3" x 50' roll of tubing and 3" coupling for streams up to 18 feet long



| MODEL | ITEM | LINER SIZE | TUBING NEEDED | FITTING NEEDED | STREAMBED LENGTH |
|----------|-------|------------|----------------------------------|------------------------|------------------|
| LI810-B | 74193 | 8' x 10' | FH1525 - 1½" x 25' PVC Flex Pipe | 429-015 - 1½" Coupling | up to 6' |
| LI1015-B | 74187 | 10' x 15' | FH225 - 2" x 25' PVC Flex Pipe | 429-020 - 2" Coupling | up to 11' |
| LI1520-B | 74189 | 15' x 20' | FH350 - 3" x 50' PVC Flex Pipe | 429-030 - 3" Coupling | up to 16' |

SKIMMER ACCESSORIES



BRUSH KIT

Atlantic's innovative Skimmer Brush Kits provide exceptional debris removal, and unlike dense filter pads, will not block water flow to the pump if neglected. Skimmers can accept an additional brush panel to increase mechanical filtration. Stainless steel and polypropylene construction provide maximum durability.



| MODEL | ITEM | LIST | DESCRIPTION | MATCH TO SKIMMER | WARRANTY |
|---------|-------|----------|-------------------|------------------|----------|
| BK4600 | 74019 | \$55.99 | Skimmer Brush Kit | PS4600 | 1-year |
| BK7000 | 74020 | \$71.99 | Skimmer Brush Kit | PS7000 | 1-year |
| BK15000 | 74018 | \$102.99 | Skimmer Brush Kit | PS15000 | 1-year |

GATE KEEPERS



Gate Keepers attach to the Skimmer weir to protect your valuable fish by keeping them from swimming into your Skimmer, while still allowing water to pass through.



| MODEL | ITEM | LIST | DESCRIPTION | WARRANTY |
|--------|-------|---------|-------------------------------|----------|
| GK600 | 74022 | \$30.99 | Gate Keeper for 6" Weir Door | 1-year |
| GK900 | 74023 | \$41.99 | Gate Keeper for 9" Weir Door | 1-year |
| GK1400 | 74021 | \$60.99 | Gate Keeper for 14" Weir Door | 1-year |

BOTTOM DRAIN KIT



A Bottom Drain Kit in your Skimmer makes it easy to keep sludge at bay by pulling debris from the bottom of your pond while the Super Flow weir door skims debris from the surface.



| MODEL | ITEM | LIST | DESCRIPTION | WARRANTY |
|--------|-------|----------|--|----------|
| BD2000 | 74017 | \$105.99 | Bottom Drain Kit for PS4600/PS7000/PS15000 | 1-year |

MATALA MAT KITS

When used in conjunction with the standard Skimmer Net and Brush Panel, Matala Mat Kits create three-stage mechanical filtration that reduces maintenance and extends the time between Skimmer cleaning.

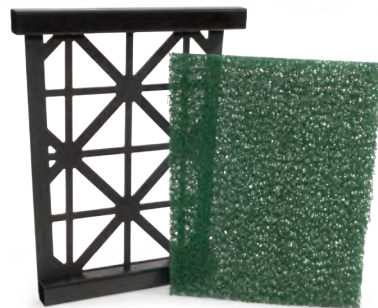

| MODEL | ITEM | LIST | DESCRIPTION | MATCH TO SKIMMER | WARRANTY |
|---------|-------|----------|-----------------------------------|------------------|----------|
| MK4600 | 74025 | \$55.99 | Matala Mat Kit with support frame | PS4600 | 1-year |
| MK7000 | 74026 | \$72.99 | Matala Mat Kit with support frame | PS7000 | 1-year |
| MK15000 | 74024 | \$107.99 | Matala Mat Kit with support frame | PS15000 | 1-year |

FILTERFALLS ACCESSORIES



BIO-ROCKS

With all the surface area but 25% less weight than lava rock and half the weight of gravel, expanded clay Bio-Rocks are the more stable, less abrasive alternative to heavyweight bio-media. Use 1 box of 0.5 cubic feet of Bio-Rocks per Media Bag.



| MODEL | ITEM | LIST | DESCRIPTION | WARRANTY |
|--------|-------|---------|-------------------------------|----------|
| BB0500 | 73987 | \$28.99 | 0.5 cubic ft. Bio-Rocks Media | 5-year |

BIO-BALLS



Atlantic's BB1500 contains 150 extremely durable, lightweight Bio-Balls that are easy to clean and reduce channeling. Each ball is 1/2" in diameter and has nearly 25 square inches of surface area for bacterial colonization. Use one box per Media Bag.



| MODEL | ITEM | LIST | DESCRIPTION | WARRANTY |
|--------|-------|---------|------------------------|----------|
| BB1500 | 73988 | \$40.99 | Bio-Balls - 150 pieces | 5-year |

MEDIA & BAGS



Atlantic's Bio-Tech Media is an economical, lightweight way to add biofiltration to your ecosystem. Atlantic's Media Bags are made with triple-stitched, heavy-duty netting and have a convenient drawstring to secure the media within your FilterFalls. Whether using with Bio-Tech Media, Bio-Balls or Bio-Rocks, Atlantic's Media Bags are meant to last.



| MODEL | ITEM | LIST | DESCRIPTION | WARRANTY |
|--------|-------|---------|--|----------|
| BB1000 | 74000 | \$33.99 | 1 cubic ft. Bio-Tech Media Blocks with bag | 1-year |
| BG2234 | 73990 | \$9.99 | 18" x 22" Media Bag | 1-year |

MATALA FILTER KITS

Customize your FilterFalls with three-stage Matala Filter Kits. Coarse, medium and fine Matala filter mats reduce channeling, increase surface area and backwash more easily than standard filter mats. Add over 300 ft² of additional Specific Surface Area per kit, up to 2 kits per FilterFalls.



| MODEL | ITEM | LIST | DESCRIPTION | MATCH TO FILTERFALLS | WARRANTY |
|--------|-------|----------|-------------------|----------------------|----------|
| MA1600 | 74001 | \$68.99 | Matala Filter Kit | BF1600 | 1-year |
| MA1900 | 74002 | \$102.99 | Matala Filter Kit | BF1900 | 1-year |
| MA2600 | 74003 | \$131.99 | Matala Filter Kit | BF2600 | 1-year |
| MA3800 | 74004 | \$189.99 | Matala Filter Kit | BF3800 | 1-year |

BACK FLUSH KIT



When used with Matala Filter Kits, Atlantic's professional Back Flush Kit virtually eliminates FilterFalls maintenance. Add a Back Flush Kit to FilterFalls for fast, convenient, powered backwashing to save you time, trouble and a whole lot of mess.



| MODEL | ITEM | LIST | DESCRIPTION | WARRANTY |
|--------|-------|----------|---|----------|
| BFK100 | 73989 | \$147.99 | Back Flush Kit for BF1900 / BF2600 / BF3800 FilterFalls | 1-year |



COMPLETE FILTER KIT



- All-in-one in-pond filters with integrated pumps clean smaller ponds and reservoirs
- OASE Complete Filter Kit combines biological and mechanical filtration with interchangeable nozzles and a separate diverter valve for increased circulation or a second water feature
- Telescoping nozzle with 360° pivoting base is easy to adjust, with built-in flow control
- Easy to install, drop-in filter with integrated grounding plate for unparalleled safety
- Sloped lid allows large debris to slide off rather than settling on the unit and clogging the intake
- Filter foam, filter pebbles and bio-media provide surface area for beneficial bacteria
- Includes pump, 15' power cord, nozzle set, ½"-1" step fitting, 2 filter sponges, bio-media elements and filter pebbles



| ITEM | LIST | DESCRIPTION | VOLTS | WATTS | MAX FLOW | CORD LENGTH | DIMENSIONS | POND VOLUME | WARRANTY |
|-------|----------|--------------------------|---------|-------|----------|-------------|---------------------|-----------------|----------|
| 45409 | \$153.99 | Complete Filter Kit 1300 | 110-120 | 40 | 580 gph | 15' | 14½"L x 11"W x 5½"H | up to 1,300 gal | 2-year |

NOZZLE PATTERNS



Single Tier
5"W x 3¼"H



Arch
1½"W x 1½"H



Bell
1½"W



FILTRAL UVC

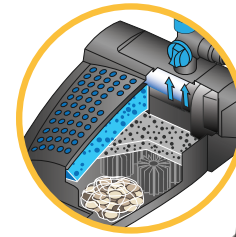

- All-in-one in-pond filters with integrated pumps and ultraviolet clarifier (UVC) for clear and healthy water
- OASE Filtral UVC filtration system combines mechanical, biological and Ultraviolet filtration
- Visually check the function of the integrated UVC without removing the unit
- Connect optional AquaOxy Set to supercharge biological filtration (Filtral UVC 1200 only), see page 120
- Pivoting telescoping nozzle with built-in flow control and diverter valve to run a small secondary water feature using the included stepped hose adapter
- Features grounding plate to protect entire installation with unparalleled safety
- Sloped lid allows large debris to slide off rather than settling on the unit and clogging the intake
- Filter foam, filter pebbles and bio-media provide surface area for beneficial bacteria
- Qualifies for the OASE Clear Water Guarantee, see page 161
- Includes pump, 15' power cord, nozzle set, 2 filter sponges, bio-media elements, filter pebbles and UVC

| ITEM | LIST | DESCRIPTION | VOLTS | WATTS | UVC | MAX FLOW | POND VOLUME | DIMENSIONS | WARRANTY |
|-------|----------|------------------|---------|-------|-----|----------|-----------------|---------------------|----------|
| 40349 | \$166.99 | Filtral UVC 700 | 110-120 | 30 | 7W | 250 gph | up to 700 gal | 9¾"L x 7¼"W x 6½"H | 2-year |
| 42749 | \$237.99 | Filtral UVC 1200 | 110-120 | 52 | 9W | 580 gph | up to 1,200 gal | 15"L x 11½"W x 6½"H | 2-year |

NOZZLE PATTERNS



Lava nozzle
Filtral UVC 700: 8"W
Filtral UVC 1200: 16"W



Vulkan nozzle
Filtral UVC 700: 22"W x 24"H
Filtral UVC 1200: 39"W x 39"H

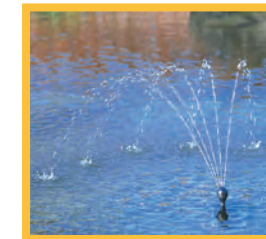

Magma nozzle
Filtral UVC 700: 20"W x 24"H
Filtral UVC 1200: 39"W x 39"H



IN-POND SKIMMERS

SWIMSKIM



- In-pond skimmers remove surface debris before it can settle to the bottom of the pond
- OASE SwimSkim with integrated pump floats on the surface, drawing debris into removable basket using patented flap technology that increases surface tension
- Cleans ponds surfaces up to 270 ft²
- Easy to use right out of the box, plug in and add to your pond
- Integrated aerator oxygenates your pond while skimming
- Versatile skimmer adapts to any pond or water feature at least 12" deep
- Includes 2 high-density filter foams, integrated pump, 15' power cord and debris basket



| ITEM | LIST | DESCRIPTION | WATTS | MAX FLOW | DIMENSIONS | SQ. FT. RATING | WARRANTY |
|-------|----------|-------------|-------|----------|--------------------|----------------|----------|
| 50040 | \$118.99 | SwimSkim | 40 | 580 gph | 13"L x 12"W x 10"H | 270 | 1-year |

AQUASKIM



- Floor mounted in-pond skimmers remove leaves and floating debris from water features
- OASE AquaSkim can be easily added to any new or existing water feature
- Telescopic design accommodates reservoir depths from 19" to 36" without modification, and as little as 11" by trimming support tube
- Float ring automatically adjusts to fluctuations in pond level up to 6"
- Easy to clean debris basket with lifting loop can be retrieved without entering pond
- Add stones to wide base to stabilize the unit
- Ideal for use with the adjustable secondary inlet of AquaMax Eco Premium pumps
- Includes Sch40 adapter and metric kink free hose adapter



| ITEM | LIST | DESCRIPTION | MIN HEIGHT | MAX HEIGHT | MIN FLOW | MAX FLOW | DIMENSIONS | HOSE SIZE | WARRANTY |
|-------|----------|-------------|------------|------------|-----------|-----------|-------------|-----------|----------|
| 57395 | \$118.99 | AquaSkim40 | 11" | 36" | 1,600 gph | 4,200 gph | 14"W x 32"H | 1" - 1½" | 2-year |



BIOPRESS



MODEL: 45451



MODEL: 40348



MODEL: 45452

- In-line pressure filters offer biological and mechanical filtration that can be located remotely
- OASE BioPress filters use mechanical, biological filtration and ultraviolet light to keep water features up to 2,400 gallons clear
- Simply pulling the integrated cleaning handle up and down cleans and backflushes the filter foams without removing the cover
- Quick release clamps make opening and closing of the filter when performing maintenance tasks easy
- Canister may be buried up to the clamps. Use the OASE FiltoCap (not included, page 59) to completely conceal the filter
- Moving bed bio-media offers additional surface area for beneficial bacteria (1600 and 2400 only)
- Easy monitoring of the UVC, filter performance and pollutant level without opening filter
- For use with pumps with a 17' shut off or less and waterfalls up to 7' higher than the filter
- Qualifies for the OASE Clear Water Guarantee when paired with the proper pump and UVC Clarifier, see page 161
- Includes 2 types of filter foams, bio-media (1600 & 2400 only), 1¼" / 1½" Sch 40 adapter, UVC, metric step fittings (¾", 1", 1¼", 1½") and 10' power cord

| ITEM | LIST | DESCRIPTION | UVC | MAX FLOW | DIMENSIONS | HOSE SIZE | POND VOLUME | WARRANTY |
|-------|----------|---------------|-----|----------|--------------|-----------|-----------------|----------|
| 45451 | \$177.99 | BioPress 1000 | 7W | 1050 gph | 9"W x 13¼"H | ¾" - 1½" | up to 1,000 gal | 2-year |
| 40348 | \$249.00 | BioPress 1600 | 9W | 2000 gph | 14"W x 17¾"H | ¾" - 1½" | up to 1,600 gal | 2-year |
| 45452 | \$309.00 | BioPress 2400 | 9W | 2120 gph | 14"W x 22½"H | ¾" - 1½" | up to 2,400 gal | 2-year |

CLEAR WATER GUARANTEE

| FILTER | UVC | PUMP |
|---------------|---------------|--------------------------|
| BioPress 1000 | 7W (included) | AquaMax Eco Classic 1200 |
| BioPress 1600 | 9W (included) | AquaMax Eco Classic 1900 |
| | | AquaMax Eco Premium 2000 |
| BioPress 2400 | 9W (included) | AquaMax Eco Classic 2700 |
| | | AquaMax Eco Premium 3000 |





FILTOCLEAR



MODEL: 40346



MODEL: 56425



MODEL: 56435

- In-line pressure filters offer biological and mechanical filtration that can be located remotely
- OASE FiltoClear filters water with mechanical and biological filtration and ultraviolet clarification (UVC)
- Compact filter size with high filtration capacity is perfect for Fountain, Formal Spillway, Pond-free and Water Garden applications
- High quality, impact resistant body can be buried up to the locking ring
- Backflush filter and direct waste with Easy-Clean Technology without opening the filter or removing the cover
- Filter Foam and UVC bulb are replaceable for longer service life

- Monitor UVC, filter performance and pollutant level without opening filter
- Easily conceal the unit with OASE FiltoCap molded decorative rock cover
- For use with pumps with a 17' shut off or less and waterfalls up to 7' higher than the filter
- Qualifies for the OASE Clear Water Guarantee when paired with the proper pump and UVC Clarifier, see page 161
- Includes 2 types of filter foam, UVC, 1½" / 2" Sch40 adapter, metric step fittings (¾", 1", 1¼", 1½") and 15' power cord

| ITEM | LIST | DESCRIPTION | UVC | MAX FLOW | DIMENSIONS | HOSE SIZE | POND VOLUME | WARRANTY |
|-------|----------|-----------------|-----|-----------|-------------|-----------|-----------------|----------|
| 40346 | \$429.99 | FiltoClear 3000 | 18W | 2,000 gph | 15"W x 20"H | ¾" - 2" | up to 3,000 gal | 2-year |
| 56425 | \$608.99 | FiltoClear 4000 | 24W | 3,000 gph | 15"W x 25"H | ¾" - 2" | up to 4,000 gal | 2-year |
| 56435 | \$727.99 | FiltoClear 8000 | 55W | 4,000 gph | 15"W x 30"H | ¾" - 2" | up to 8,000 gal | 2-year |

CLEAR WATER GUARANTEE

| FILTER | UVC | PUMP |
|------------------|----------------|--------------------------|
| FiltroClear 3000 | 18W (included) | AquaMax Eco Classic 1900 |
| | | AquaMax Eco Premium 2000 |
| FiltroClear 4000 | 24W (included) | AquaMax Eco Classic 2700 |
| | | AquaMax Eco Premium 3000 |
| FiltroClear 8000 | 55W (included) | AquaMax Eco Classic 3600 |
| | | AquaMax Eco Premium 4000 |

FILTOCLEAR FEATURES:



1. In addition to metric step barbs, FiltoClear filters come with Sch 40 adapter fittings that work with both 2" and 1½" Flexible and Rigid PVC
2. Canister portion of the unit can be buried up to the locking ring
3. 2 different filter foam layered inside for optimal filtration
4. Effective UVC technology cleans the green out of the water
5. Cleaning lever folds down for storage
6. Easy-Clean Technology Rotary Switch
7. Monitor and replace UVC bulb without tools or removing lid

PATENTED EASY-CLEAN TECHNOLOGY



Makes filter and UVC maintenance possible in a matter of minutes.

Rotary switch on »Filter«

1. Water flows through the filter foams removing particulates and suspended solids.
2. The water then passes through the integrated UVC clarifier, eliminating and clearing green water.
3. The clean, clarified water is returned to the pond.

Rotary switch on »Clean«

1. Turning the rotary switch activates the cleaning function.
2. Pulling the cleaning lever up and down squeezes the collected debris out of the filter foams while clean water flushes it out through the backwash outlet.

FILTOCAP

Decorative rock cover conceals all partially buried BioPress and FiltoClear filters. Sand color blends in well with any landscape.



| ITEM | LIST | DESCRIPTION | WARRANTY |
|-------|----------|--|----------|
| 46981 | \$213.99 | FiltoCap for BioPress & FiltoClear Filters | 1-year |

DID YOU KNOW?



OASE pressure filters can be used with multiple Atlantic Systems! Add extra filtration to your Formal Spillway Hardscape Basin or your Pond-free waterfall. Just add a tee and ball valve to divert partial water flow to the FiltoClear and add a return line to your water feature.



BIOSMART



56929

- Flow through bio-mechanical filters clean and clear pond water which returns to the pond by gravity
- OASE BioSmart filters use multiple filter zones to slow water, remove debris and provide surface area for beneficial bacteria
- As water velocity slows in the filter, fine particles in suspension settle and are trapped in the filter zones
- No need to remove or manually unclog the filter foams to clean
- Three types of high-surface area filter foams provide exceptional biological filtration capacity to remove ammonia and nitrites



56930

- Qualifies for the OASE Clear Water Guarantee when paired with the proper pump and UVC Clarifier, see page 161
- Includes filter foams, 3" Sch40 outlet adapter and metric step fittings (3/4", 1 1/4", 1 1/2")

| ITEM | LIST | DESCRIPTION | OUTLET | MAX FLOW | DIMENSIONS | HOSE SIZE | POND VOLUME | WARRANTY |
|-------|----------|----------------|--------|-----------|--------------------|---------------|------------------|----------|
| 56929 | \$201.99 | BioSmart 5000 | 3" | 2,700 gph | 22"L x 22"W x 16"H | 3/4" - 1 1/2" | up to 5,000 gal | 3-year |
| 56930 | \$368.99 | BioSmart 10000 | 3" | 3,600 gph | 30"L x 22"W x 16"H | 3/4" - 1 1/2" | up to 10,000 gal | 3-year |

BIOSMART 5000 & 10000 FEATURES:



1. Gardena style hose attachment for easy winterizing
2. Easily add a Vitronic Ultraviolet Clarifier using the pre-drilled inlets (not shown)
3. 2 1/2" outlet accepts 3" Sch 40 adapter (included)
4. Cleaning indicator alerts when the system needs cleaning
5. Cleaning handles squeeze debris out of the filter foams
6. Sludge drain flushes debris through 2" outlet
7. The thermometer in the temperature display indicates the current water temperature at all times.
8. Innovative venturi intakes integrated into filter provide supplemental oxygenation (not shown)
9. Attachment nipple for AquaOxy 450 for supplemental aeration

CLEAR WATER GUARANTEE

| FILTER | UVC | PUMP |
|----------------|-------------|--------------------------|
| BioSmart 5000 | Vitronic 18 | AquaMax Eco Classic 1900 |
| | | AquaMax Eco Premium 2000 |
| BioSmart 10000 | Vitronic 36 | AquaMax Eco Classic 2700 |
| | | AquaMax Eco Premium 3000 |

CLEANING PROCEDURE



1. Remove Lid
2. Lift up on the sludge drain handle to open the drain
3. Pull up slowly on the filter foam cleaning handles, hold for five seconds and release. Repeat 3-4 times to remove most of the debris from the filter foams. To maintain beneficial bacteria levels do not completely clean foams.
4. Once all of the filter foams have been cleaned close the sludge drain valve and reattach the lid.



DID YOU KNOW?

OASE BioSmart can be added to any new or existing pond or water garden. Simply assure that the unit is set high enough to allow the output to flow downhill back into the pond. Use with an AquaMax Eco Classic or Premium to qualify for the OASE Clear Water Guarantee. See page 161 for more information.



BIOTEC SCREENMATIC²



42975

44120

42976

- Flow through filters with biological and mechanical filtration clean and clear pond water which flows back down to the pond by gravity
- OASE BioTec Screenmatic² automatically separates debris using the self-cleaning screen, depositing coarse debris into the removable tray
- Intelligent cleaning sensor detects pollutant levels entering filter and automatically activates the screen
- High efficiency filter system features 3 different densities of foam harboring a variety of beneficial bacteria that remove harmful ammonia and nitrites
- Double-sealed screen motor and reinforced screen material ensures an extended service life

- Foam distribution and optimized water level in the container ensure longer filter service life, improved filtration and reduced maintenance
- Filter foams clean directly inside the filter in pond water to preserve beneficial bacteria colonies and reduce water waste
- Slide valve on sludge drain removes sludge and dirty water with minimal mess
- Add an optional Bitron C UVC clarifier to any ScreenMatic² filter system for enhanced clarity and cleaner water
- Qualifies for the OASE Clear Water Guarantee when paired with the proper pump and UVC Clarifier, see page 161

| ITEM | LIST | DESCRIPTION | WATTS | OUTLET | MAX FLOW | DIMENSIONS | HOSE SIZE | POND VOLUME | WARRANTY |
|-------|------------|--|-------|------------|-----------|---------------------|------------------|------------------|----------|
| 42975 | \$984.99 | BioTech ScreenMatic ² 18000 | 5 | 3" adapter | 2,900 gph | 31"L x 23"W x 21½"H | 1", 1¼", 1½" | up to 18,000 gal | 3-year |
| 44120 | \$1,231.99 | BioTech ScreenMatic ² 24000 | 5 | 4" | 3,300 gph | 31"L x 23"W x 25½"H | 1", 1¼", 1½" | up to 24,000 gal | 3-year |
| 42976 | \$2,464.99 | BioTech ScreenMatic ² 38000 | 5 | 4" | 4,600 gph | 47"L x 31½"W x 30"H | 1", 1¼", 1½", 2" | up to 38,000 gal | 3-year |

BIOTEC SCREENMATIC² FEATURES:



1. Intelligent cleaning sensor senses debris and activates cleaning screen
2. Manual belt run button for manual operation of cleaning screen
3. LED indicates status of cleaning bar and screen
4. Rubberized separator lip scrapes debris off screen and into tray
5. Removable sludge tray for easy maintenance
6. Built-in overflow holes keeps filter operational even when sludge tray is full
7. Sludge drain with integrated slide valve removes sludge and dirty water from system
8. Optimized water distributor evenly disperses water flow over screen
9. Storm-safe fastening clips lock down filter lids (BioTecScreenMatic² 18000 and 24000 only)

CLEAR WATER GUARANTEE

| FILTER | UVC | PUMP |
|--|--------------|--------------------------|
| BioTech ScreenMatic ² 18000 | Bitron C 55 | AquaMax Eco Classic 3600 |
| | | AquaMax Eco Premium 4000 |
| BioTech ScreenMatic ² 24000 | Bitron C 55 | AquaMax Eco Classic 3600 |
| | Bitron C 110 | AquaMax Eco Premium 4000 |
| BioTech ScreenMatic ² 38000 | Bitron C 110 | AquaMax Eco Premium 4000 |
| | | AquaMax Eco Expert 6800 |



TECH TIP

Although flow through filtration has to be above water level, they are easier to hide than you might think. BioTec ScreenMatic² can be remotely located in sheds, behind walls, plantings or decorative screens wherever an electric source is easily accessible.



PROFICLEAR PREMIUM



72374

- Drum filters utilize a rotating screen to remove debris and moving bed filtration to strip ammonia and nitrites from the water
- OASE ProfiClear Premium is a fully automatic filter system that offers hands-free operation of even fully stocked koi ponds
- Pump-fed, flow-through drum filter provides effective cleaning and polishing of water down to 80 microns
- Drum is fully self-cleaning with a built-in 29 psi high-pressure cleaning pump and automatic 4" waste discharge outlet
- Moving Bed System with 40 liters of Hel-X Bio-media provides optimal biological filtration capable of decomposing up to 10 oz. of food waste per day
- Filter capacity can be upgraded by adding an additional 20 liters of Hel-X Bio-media
- Micro control system offers a choice of manual cleaning, time interval cleaning or full automatic cleaning via sensor

NEW!



73379

- Can be buried up to UVC mounts for maximum versatility in filter placement near existing electrical source
- Pre-installed insulation on the lid ensures quiet operation during cleaning cycles
- Digital temperature display provides accurate water temperatures for seasonal maintenance
- Add an optional Bitron C UVC clarifier to either ProfiClear Premium filter system for enhanced clarity and cleaner water
- Integrated linear air stones provide extra oxygen in the module with included connection kit for AquaOxy 450 (not included)
- Qualifies for the OASE Clear Water Guarantee when paired with the proper pump and UVC Clarifier,
- Fully control your ProfiClear Compact-M or -L with the Easy Garden Control (EGC) system from anywhere in the world (not included)

| ITEM | LIST | DESCRIPTION | VOLTS | WATTS | INLET | OUTLET | MAX FLOW | DIMENSIONS | POND VOLUME | WARRANTY |
|-------|------------|---------------------------------------|-------|----------------|-------|--------|-----------|----------------------|------------------|----------|
| 72374 | \$3,988.99 | ProfiClear Premium Compact-M Pump-fed | 120 | 870 (cleaning) | 2" | 4" | 4,000 gph | 35"L x 27"W x 32"H | up to 21,000 gal | 3-year |
| 73379 | \$5,470.99 | ProfiClear Premium Compact-L Pump-fed | 120 | 870 (cleaning) | 3" | 4" | 5,280 gph | 53"L x 35½"W x 32½"H | up to 31,500 gal | 3-year |

PROFICLEAR PREMIUM FEATURES:



1. Dual inlets accommodate optional Bitron C UVC Clarifier
2. Secondary inlet accommodates 2" pipe for non-UVC equipped installations
3. Micro control unit automates cleaning functions and can be connected to an Easy Garden Control (EGC) system
4. Made from German engineered GFK Duroplast for enhanced structural integrity
5. Drain with integrated slide valve clears sludge as needed
6. Drum filter with removable micro sieve that can be upgraded to finer 60 micron screen and manually cleaned if needed
7. Spray bar removes fine particles from micro sieve
8. Hel-X floating bed Bio-media may be supplemented for additional biological filtration
9. Discharge returns clean water to pond
10. Dirty water discharge 4" outlet

EASY GARDEN CONTROL

Connect your ProfiClear Premium to the Easy Garden Control (EGC) System to fully control the filter from anywhere in the world on any Android or Apple Device with EGC mobile application. See page 5 for more information on the EGC Cloud Controller.

The EGC System App can display and control a variety of functions including:

- Operational status
- Filtration cycles
- Water Temperature
- Cleaning time
- Interval time
- Manual cleaning
- Overall performance data
- Comparison charts with data collected over time



EGC Cloud Controller

CLEAR WATER GUARANTEE

| FILTER | UVC | PUMP |
|---------------------------------------|--------------|--------------------------|
| ProfiClear Premium Compact-M Pump-fed | Bitron C 55 | AquaMax Eco Premium 4000 |
| | Bitron C 110 | AquaMax Eco Expert 6800 |
| ProfiClear Premium Compact-L Pump-fed | Bitron C 110 | AquaMax Eco Premium 4000 |
| | | AquaMax Eco Expert 6800 |

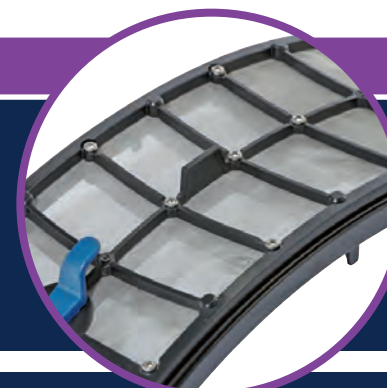

DID YOU KNOW?

The ProfiClear Premium filters use a high pressure pump to keep the tiny perforations in the sieve clean automatically. The powerful pump draws significant wattage during operation, but only operates a fraction of the time to keep total electrical usage minimal. When the pump is not running, the filter only uses 5 watts of electricity.



VITRONIC



BITRON C



45427

- Ultraviolet clarifiers clean and clear pond water with UVC band light
- OASE Vitronic UVC clarifiers offer powerful standalone clarification that integrates with OASE BioSmart filters
- Properly sized, clarifiers clean the green out of the water of any water feature
- Quick release ballast allows fast quartz sleeve maintenance and easy bulb changes



56455

- Ultraviolet clarifiers clean and clear pond water with UVC band light
- OASE Vitronic UVC clarifiers offer powerful standalone clarification that integrates with OASE BioSmart filters
- Properly sized, clarifiers clean the green out of the water of any water feature
- Quick release ballast allows fast quartz sleeve maintenance and easy bulb changes



40350

- Clear tubing adapters and indicator light show the clarifier is working
- Vitronic 18 and 36 watt units install easily on the housing of BioSmart filters (5000 & 10000 only)
- For use with pumps with a 17' shut off or less
- Qualifies for the OASE Clear Water Guarantee when paired with the proper pump and UVC clarifier, see page 161

| ITEM | LIST | DESCRIPTION | WATTS / UVC | HOSE SIZE | MAX FLOW | CORD | DIMENSIONS | POND VOLUME | WARRANTY |
|-------|----------|-------------|-------------|------------------|----------|------|------------------|------------------|----------|
| 45427 | \$146.99 | Vitronic 9 | 9 | ¾", 1", 1¼", 1½" | 500 gph | 10' | 13"L x 5"W x 4"H | up to 2,500 gal | 2-year |
| 56455 | \$204.99 | Vitronic 18 | 18 | 1", 1¼", 1½" | 925 gph | 15' | 21"L x 7"W x 5"H | up to 5,000 gal | 2-year |
| 40350 | \$287.99 | Vitronic 36 | 36 | 1", 1¼", 1½" | 1585 gph | 15' | 21"L x 7"W x 5"H | up to 10,000 gal | 2-year |

CLEAR WATER GUARANTEE

| UVC | FILTER | PUMP |
|-------------|----------------|--------------------------|
| Vitronic 18 | BioSmart 5000 | AquaMax Eco Premium 2000 |
| Vitronic 36 | BioSmart 10000 | AquaMax Eco Premium 3000 |



56936

- Ultraviolet clarifiers clean and clear pond water with UVC band light
- OASE Bitron C UVC clarifiers clean the green out of water in either standalone configurations or integrated with OASE filters
- Bitron C clarifiers mount directly to OASE BioTec Screenmatic² and ProfiClear Premium filters
- Quick-release fastener for easy opening of the bulb housing
- Safety switch deactivates the UVC bulb when bulb housing is open to prevent eye injury
- Inspection window allows visual inspection of the UVC bulb and self-cleaning feature



57101

- Bitron C 55 may be used with pumps with a 17' shut off or less; Bitron C 110 may be used with pumps with up to a 34' shut off
- Adjustable flow control optimizes water flow through the UVC chamber
- Automatic cleaning rotor powered by water flow, continuously glides around the quartz glass tube preventing debris from settling on quartz glass
- Qualifies for the OASE Clear Water Guarantee when paired with the proper pump and UVC Clarifier, see page 161



| ITEM | LIST | DESCRIPTION | WATTS/ UVC | HOSE SIZE | MAX FLOW | CORD | DIMENSIONS | POND VOLUME | WARRANTY |
|-------|----------|-------------|------------|----------------------|------------|------|------------------|------------------|----------|
| 56936 | \$416.99 | Bitron C 55 | 55 | ¾", 1", 1¼", 1½", 2" | 8,000 gph | 15' | 24"L x 7"W x 7"H | up to 18,000 gal | 2-year |
| 57101 | \$596.99 | Bitron C110 | 110 | ¾", 1", 1¼", 1½", 2" | 11,000 gph | 15' | 29"L x 9"W x 8"H | up to 36,000 gal | 2-year |

CLEAR WATER GUARANTEE

| UVC | FILTER | PUMP |
|--|--|--------------------------|
| Bitron C 55 | BioTech ScreenMatic ² 18000 | AquaMax Eco Classic 3600 |
| | | AquaMax Eco Premium 4000 |
| Bitron C 55 / Bitron C 110 | ProfiClear Premium Compact-M pump-fed | AquaMax Eco Classic 3600 |
| | | AquaMax Eco Premium 4000 |
| Bitron C 110 | BioTech ScreenMatic ² 24000 | AquaMax Eco Premium 4000 |
| | | AquaMax Eco Premium 4000 |
| | ProfiClear Premium Compact-M ProfiClear Premium Compact-L | AquaMax Eco Classic 3600 |
| AquaMax Eco Premium 4000 | | |
| BioTech ScreenMatic ² 38000 | BioTech ScreenMatic ² 38000 | AquaMax Eco Classic 3600 |
| | | AquaMax Eco Expert 6800 |

TECH TIP

UVC bulbs have a service life of 9,000 hours, about a year of typical use. At that point output drops to a level that is ineffective at controlling green water, so the bulb should be changed. Change bulbs every spring when nutrient levels are at their highest after the winter and other plants are not yet actively growing.

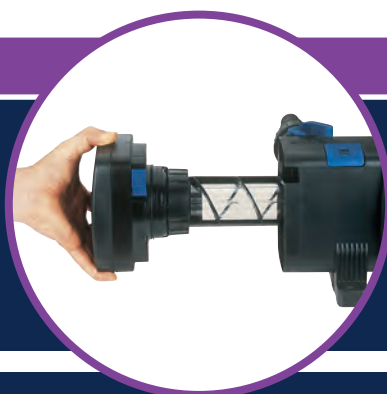

P PUMP

Atlantic's Pump Products offer the perfect solution for all water features, large and small. Whether the application calls for Mag Drive or Direct Drive, Axial or Asynchronous, or OASE leading edge brushless DC performance, our pumps deliver the right flow at the right head for the right wattage. Advanced design, top quality components and world class support ensure our pumps will deliver years of trouble-free service.

- » Fountain pumps offer adjustable flows and multiple adapters for ease of installation and adjustment
- » Magnetic pumps make better flows at higher head heights and are the easiest to service in the industry
- » Asynchronous pumps have the most powerful, most efficient and smallest footprint on the market, offering tool-free maintenance and an optional Variable Speed Controller
- » Direct Drive pumps deliver high head and solids handling for the most demanding in-pond applications
- » Brushless DC fountain pumps provide a multitude of pre-set programs, while brushless DC water garden versions adjust from low to extremely high flows for the lowest wattages ever



COMPREHENSIVE PUMP CHART

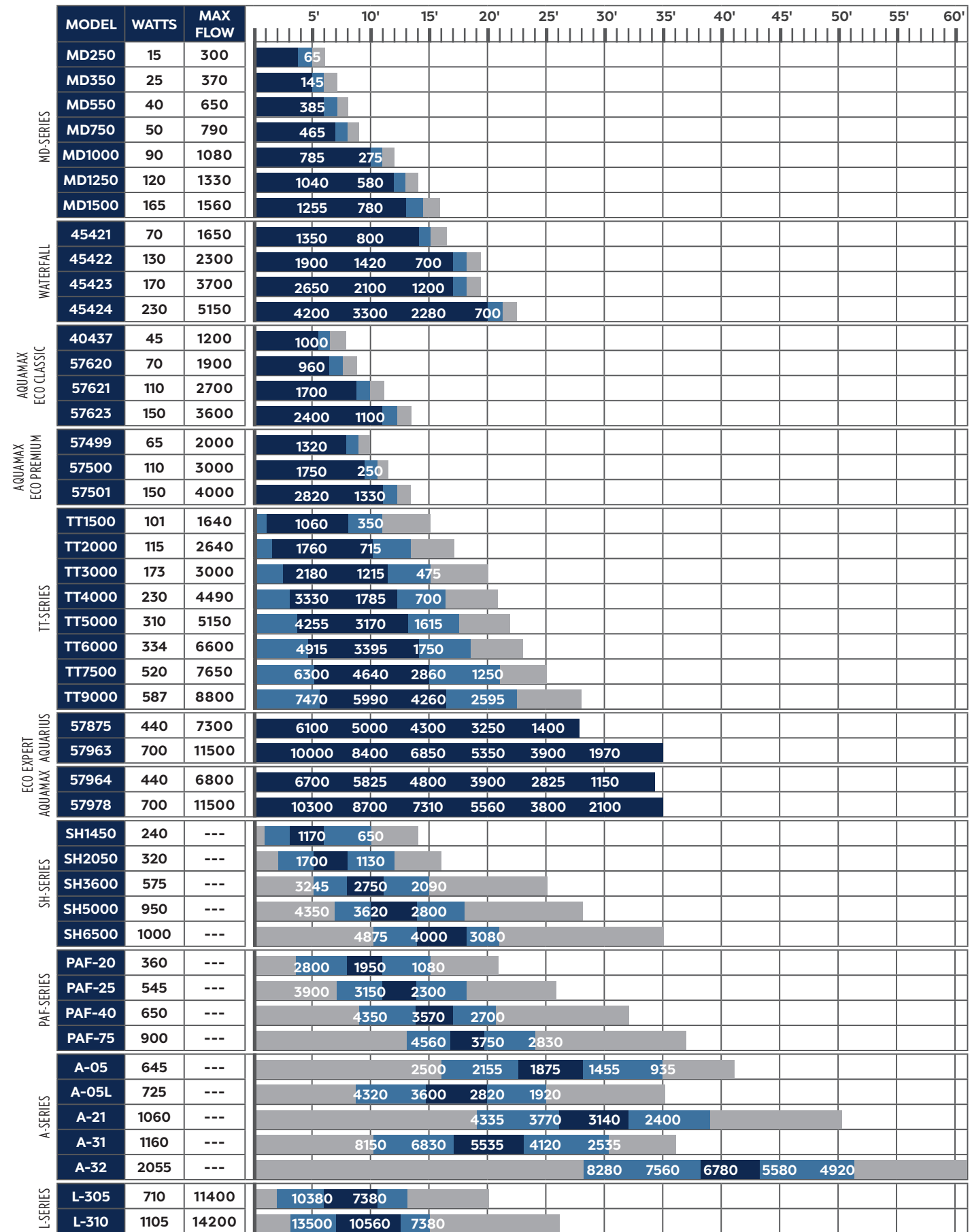

Recommended Operating Range Best Efficiency Range Do Not Operate Range



TIDALWAVE FP- & MD-SERIES PUMPS

FP-SERIES



- Fountain Pumps offer Magnetic Induction performance and replaceable components in a tiny footprint for the smallest water features
- Atlantic FP-Series Pumps fit in the smallest spaces for reliable, adjustable performance in your wall and table top fountains
- Integrated valve allows flow adjustment in spaces where a separate valve wouldn't fit
- Removable washable foam filter protects internal components from wear
- Standard size fittings facilitate connection to various sizes and types of tubing
- Energy efficient motors keep operating costs to a minimum
- Impeller assemblies replace quickly, no tools needed for extended service life

| MODEL | ITEM | LIST | VOLTS | WATTS | INLET | OUTLET | CORD | DIMENSIONS | OUTLET FITTING | WARRANTY |
|-------|-------|----------|-------|-------|------------|---------|------|--------------------|----------------|----------|
| FP100 | 73816 | \$27.99 | 115 | 7 | Adjustable | ½" MIPT | 6' | 3½"L x 2¼"W x 2½"H | ½" - ¾" Insert | 1-year |
| FP200 | 73817 | \$37.99 | 115 | 9.5 | Adjustable | ½" MIPT | 6' | 3½"L x 2¼"W x 2½"H | ½" - ¾" Insert | 1-year |
| FP300 | 75472 | \$55.99 | 115 | 16 | Adjustable | ½" FIPT | 16' | 5"L x 3"W x 3¼"H | ½" - ¾" Insert | 1-year |
| FP400 | 73818 | \$61.99 | 115 | 24 | Adjustable | ½" FIPT | 16' | 5"L x 3"W x 3¼"H | ½" - ¾" Insert | 1-year |
| FP500 | 75474 | \$101.99 | 115 | 33 | Adjustable | ½" FIPT | 16' | 5¼"L x 3½"W x 4"H | ½" - ¾" Insert | 1-year |

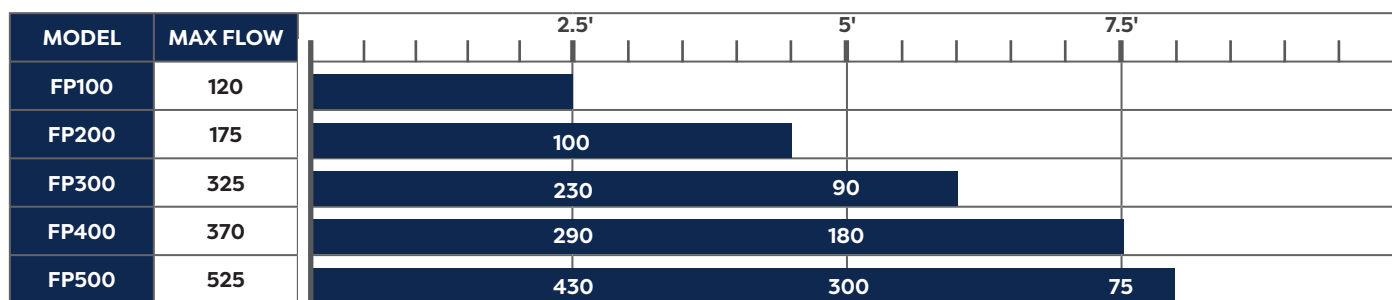

MD-SERIES

MD1000



MD1500



Add a fountain head to your MD-Series pump on page 79

- Magnetic Induction pumps provide years of service under the demanding conditions of smaller ponds, waterfalls and fountains
- Atlantic MD-Series pumps feature better flows at higher heads, a longer warranty and are easier to service
- Male threads on both inlet and outlet are less restrictive for higher flow
- Volute rotates to accommodate any pump orientation
- A quarter-turn of the volute accesses the impeller assembly for easy periodic cleaning
- Oversized ceramic shaft resists wear better than steel, for longer service life
- Impeller assembly replaces quickly and easily to keep pump running for years
- Large, stable base for anchoring pump may be removed in tight applications
- Removable pre-filter provides integrated filtration, reduces internal wear and extends impeller life
- Included outlet fittings are tapered to fit a wide array of tubing types and sizes
- MD1000 through MD1500 include ½" adapters for use with Triton Check Valve and Fountain Plumbing Kits
- Five-year warranty on pump and motor, one-year warranty on impeller assembly

| MODEL | ITEM | LIST | VOLTS | WATTS | INLET | OUTLET | CORD | DIMENSIONS | OUTLET FITTING | WARRANTY |
|--------|-------|----------|-------|-------|----------|---------|------|--------------------|----------------|----------------|
| MD250 | 73822 | \$89.99 | 115 | 15 | 1" MIPT | ¾" MIPT | 20' | 4½"L x 3½"W x 5"H | ¾" - 1" Step | 5-year Limited |
| MD350 | 73823 | \$95.99 | 115 | 25 | 1" MIPT | ¾" MIPT | 20' | 4½"L x 3½"W x 5"H | ¾" - 1" Step | 5-year Limited |
| MD550 | 73824 | \$106.99 | 115 | 40 | 1" MIPT | ¾" MIPT | 20' | 4½"L x 3½"W x 5"H | ¾" - 1" Step | 5-year Limited |
| MD750 | 73825 | \$119.99 | 115 | 50 | 1" MIPT | ¾" MIPT | 20' | 4½"L x 3½"W x 5"H | ¾" - 1" Step | 5-year Limited |
| MD1000 | 73819 | \$173.99 | 115 | 90 | 1½" MIPT | 1" MIPT | 20' | 5½"L x 4¼"W x 5½"H | 1" - 1½" Step | 5-year Limited |
| MD1250 | 73820 | \$213.99 | 115 | 120 | 1½" MIPT | 1" MIPT | 20' | 5½"L x 4¼"W x 5½"H | 1" - 1½" Step | 5-year Limited |
| MD1500 | 73821 | \$241.99 | 115 | 165 | 1½" MIPT | 1" MIPT | 20' | 6"L x 4¼"W x 6"H | 1" - 1½" Step | 5-year Limited |

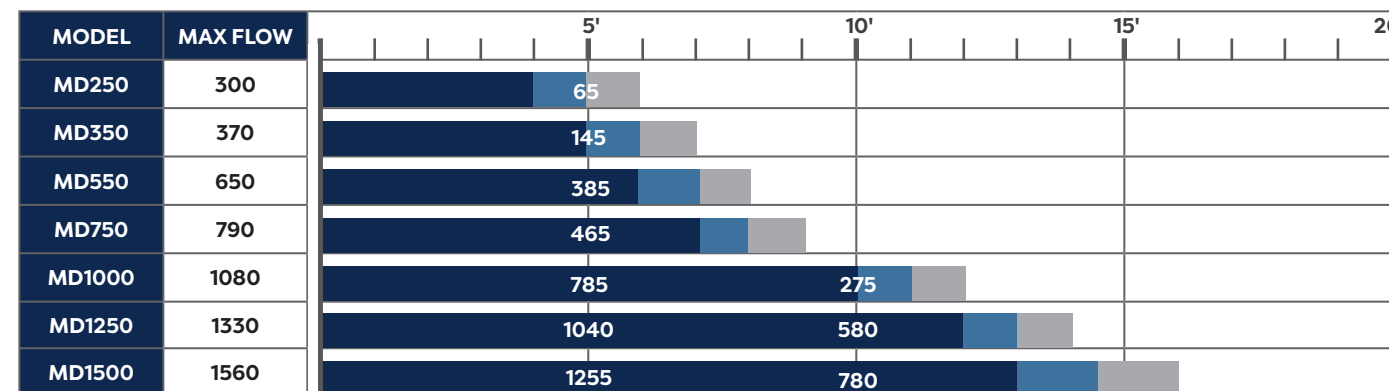



TIDALWAVE TT-SERIES PUMPS



- Asynchronous Pumps combine the efficiency of Magnetic Induction with the power of Direct Drive geometry, keeping operating and ownership costs to a minimum
- Atlantic TT-Series pump more water for less watts, making them the ideal choice for water gardens and continuously operated water features
- Compact design fits the tightest pump chambers, perfect for vertical and multiple pump applications
- Excellent resistance to fouling in hard water environments and simple maintenance keeps pumps running in adverse conditions
- Ribs and large openings in pre-filter and handle provide tremendous surface area for greater clog resistance, decreasing upkeep and increasing pump life

| MODEL | ITEM | LIST | VOLTS | AMPS | WATTS | INLET | OUTLET | CORD | DIMENSIONS | OUTLET FITTING | WARRANTY |
|--------|-------|----------|-------|------|-------|-----------|-------------------|------|-------------------------|----------------|----------|
| TT1500 | 73924 | \$192.99 | 120 | 0.88 | 101 | 1/2" MIPT | 1/2" FIPT | 20' | 8"L x 5 1/4"W x 6 1/4"H | 1" - 1/2" Step | 3-year |
| TT2000 | 73925 | \$214.99 | 120 | 1.0 | 115 | 1/2" MIPT | 1/2" FIPT | 20' | 8"L x 5 1/4"W x 6 1/4"H | 1" - 1/2" Step | 3-year |
| TT3000 | 73926 | \$256.99 | 120 | 1.5 | 173 | 1/2" MIPT | 1/2" FIPT | 20' | 8"L x 5 1/4"W x 6 1/4"H | 1" - 1/2" Step | 3-year |
| TT4000 | 73927 | \$363.99 | 120 | 2.0 | 230 | 1/2" MIPT | 1/2" FIPT | 20' | 9 1/4"L x 6"W x 7"H | 1" - 1/2" Step | 3-year |
| TT5000 | 73928 | \$406.99 | 120 | 2.7 | 310 | 2" MIPT | 2" FIPT | 20' | 9 1/4"L x 6"W x 7"H | 2" Insert | 3-year |
| TT6000 | 73929 | \$449.99 | 120 | 2.9 | 334 | 2" MIPT | 2" FIPT | 20' | 9 1/4"L x 6"W x 7"H | 2" Insert | 3-year |
| TT7500 | 73930 | \$577.99 | 120 | 4.4 | 520 | 2" MIPT | 2" FIPT / 3" MIPT | 20' | 11"L x 7 1/4"W x 8"H | --- | 3-year |
| TT9000 | 73931 | \$620.99 | 120 | 5.1 | 587 | 2" MIPT | 2" FIPT / 3" MIPT | 20' | 11"L x 7 1/4"W x 8"H | --- | 3-year |

| MODEL | MAX FLOW | 5' | 10' | 15' | 20' | 25' | 30' |
|--------|----------|------|------|------|------|------|-----|
| TT1500 | 1640 | 1060 | 350 | | | | |
| TT2000 | 2640 | 1760 | 715 | 150 | | | |
| TT3000 | 3000 | 2180 | 1215 | 475 | | | |
| TT4000 | 4490 | 3330 | 1785 | 700 | 90 | | |
| TT5000 | 5150 | 4255 | 3170 | 1615 | 395 | | |
| TT6000 | 6600 | 4915 | 3395 | 1750 | 265 | | |
| TT7500 | 7650 | 6300 | 4640 | 2860 | 1250 | | |
| TT9000 | 8800 | 7470 | 5990 | 4260 | 2595 | 1005 | |

Recommended Operating Range Best Efficiency Range Do Not Operate Range

TT-SERIES PUMP FEATURES:

1. Large threaded inlet and outlet for less restriction and greater flows.
2. Quarter-turn volute provides access to impeller without the use of tools.
3. Heavy-duty pre-filter locks in place. Large openings and increased surface area resist clogging.
4. Three-vane hybrid impeller improves flows and passes solids easily.
5. Additional perforations in handle provide greater surface area.
6. Energy efficient asynchronous motor is up to 30% more efficient than the competition.
7. All models feature 20' power cord and three-year warranty.



Control your flow with a Variable Speed Controller on page 78.



TT-SERIES PUMP CLEANING:

The rotors of asynchronous TT-Series Pumps are water cooled, with a screen to keep grit out of the rotor chamber. Regular cleaning and maintenance is the best way to get the most out of your pump, especially in harsh environments. In areas with very hard water, calcification (lime scale) can build up around the impeller assembly or motor housing of TT-Series pumps, leading to overheating or even seizing. **Clean your pump after the first month of operation to determine how often you'll need to perform maintenance.**

Cleaning Procedures:

1. Unlock the latches on either side of the pre-filter by pulling outward from the pump handle. Slide the pre-filter off to expose the volute.
2. Remove the volute by rotating counterclockwise one quarter turn while pulling lightly outward from the pump body.
3. Inspect the intake O-ring for nicks or breaks.
4. Inspect the impeller and remove any debris that may be present.
5. A stainless steel screen located behind the impeller draws water in to cool the rotor. If the screen becomes blocked the pump may overheat. Inspect the screen and remove any accumulated debris.
6. Spin the impeller. If the impeller is difficult to turn, feels "gritty", or a grinding noise is evident in the rotor chamber, remove and clean the rotor.
7. Reassemble. Lubricate o-ring with 100% silicone grease if needed.

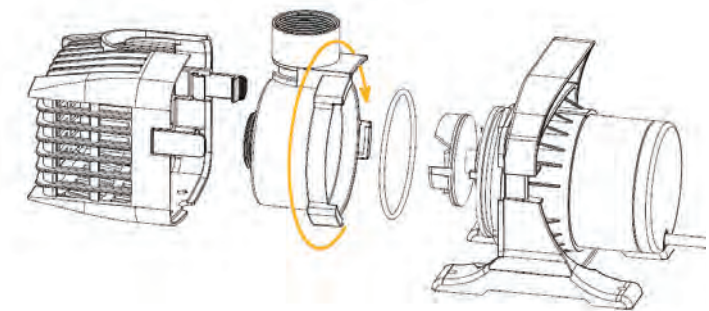

Removing the Rotor:

The rotor must be unlocked using the built-in wrench located on the bottom of the pre-filter before it can be removed from the rotor chamber. Slide the impeller wrench behind the impeller and engage two of the locking posts located on the face of the rotor. Push the wrench tightly against the rotor face and rotate counterclockwise one quarter turn. Once unlocked, remove the rotor by pulling the impeller outward from the pump body.

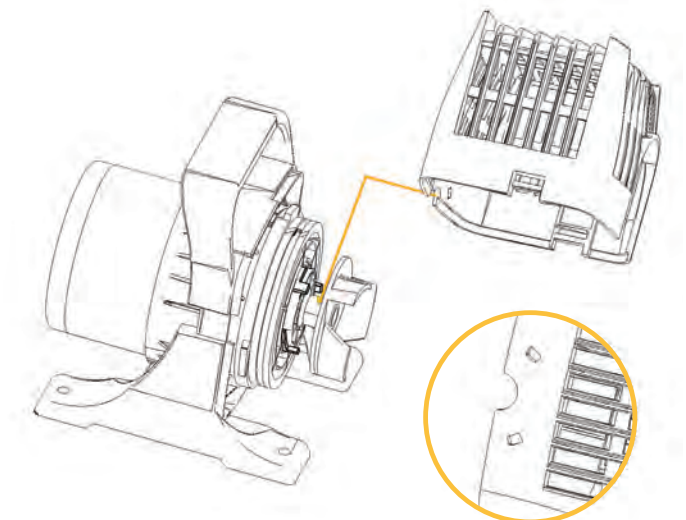



TIDALWAVE PAF-SERIES PUMPS



PAF-20

PAF-75



- Direct Drive pumps are perfect for demanding medium head, high-volume applications
- Atlantic PAF-Series pumps feature energy efficient direct drive motors, double silicone carbide mechanical seals and fiber-reinforced vortex impellers to ensure dependable, long lasting service
- Overload and thermal protection shuts down pump before overheating can cause damage
- Stainless steel and high impact FRP composite housings are rugged and lightweight, for easier servicing and long life
- Removable intake screen converts pump from clean water in skimmers to true 1/4" solids handling capacity in ponds



| MODEL | ITEM | LIST | MOTOR | VOLTS | AMPS | WATTS | OUTLET | CORD | DIMENSIONS | OUTLET FITTING | WARRANTY |
|--------|-------|----------|--------|-------|------|-------|---------|------|-------------------|----------------|----------|
| PAF-20 | 73899 | \$480.99 | 1/4 HP | 115 | 3.5 | 360 | 2" FIPT | 20' | 9"L x 6"W x 14"H | 2" Insert | 2-year |
| PAF-25 | 73900 | \$570.99 | 1/3 HP | 115 | 5 | 545 | 2" FIPT | 20' | 9"L x 6"W x 14½"H | 2" Insert | 2-year |
| PAF-40 | 73901 | \$636.99 | 1/2 HP | 115 | 6 | 650 | 2" FIPT | 20' | 9"L x 6"W x 15"H | 2" Insert | 2-year |
| PAF-75 | 73902 | \$734.99 | 1 HP | 115 | 8.5 | 900 | 2" FIPT | 20' | 9"L x 6"W x 16"H | 2" Insert | 2-year |

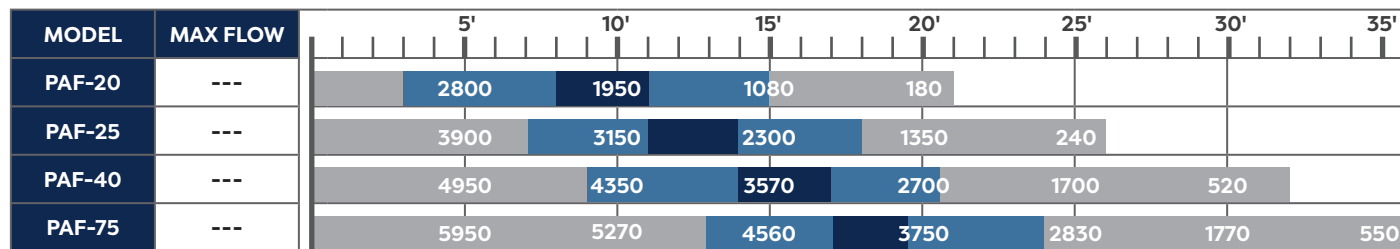

■ Recommended Operating Range
 ■ Best Efficiency Range
 ■ Do Not Operate Range



TIDALWAVE SH-SERIES PUMPS



SH2050

SH5000



- Direct Drive pumps have heavy-duty impellers attached directly to the motor for cleanouts and in-pond applications
- Atlantic SH-Series Direct Drive pumps thrive in dirty water applications, with higher head pressures and solids capability
- Pumps handle solids up to 1½" in diameter for the most demanding in-pond and dewatering applications
- Overload and thermal protection shuts down pump before overheating can cause damage
- Non-corroding, high impact composite housing and stable base geometry make SH-Series the perfect clean-out pump
- For in-pond use, SH-Series pumps will last longest when operating within their Recommended or Best Efficiency Range

| MODEL | ITEM | LIST | VOLTS | AMPS | WATTS | OUTLET | CORD | DIMENSIONS | OUTLET FITTING | WARRANTY |
|--------|-------|----------|-------|------|-------|----------|------|---------------------|----------------------|----------|
| SH1450 | 73904 | \$251.99 | 115 | 2.1 | 240 | 1¼" FIPT | 16' | 6"L x 9"W x 11¾"H | 1¼" x 1½" FIPT Elbow | 2-year |
| SH2050 | 73905 | \$293.99 | 115 | 2.8 | 320 | 1¼" FIPT | 16' | 6"L x 9"W x 12½"H | 1¼" x 1½" FIPT Elbow | 2-year |
| SH3600 | 73906 | \$408.99 | 115 | 5.5 | 575 | 1¼" FIPT | 16' | 6"L x 9"W x 14"H | 1¼" x 1½" FIPT Elbow | 2-year |
| SH5000 | 73907 | \$622.99 | 115 | 9 | 950 | 1½" FIPT | 16' | 9½"L x 12"W x 15¾"H | 1½" x 1½" FIPT Elbow | 2-year |
| SH6500 | 73908 | \$652.99 | 115 | 9.5 | 1000 | 1½" FIPT | 16' | 9½"L x 12"W x 15¾"H | 1½" x 1½" FIPT Elbow | 2-year |

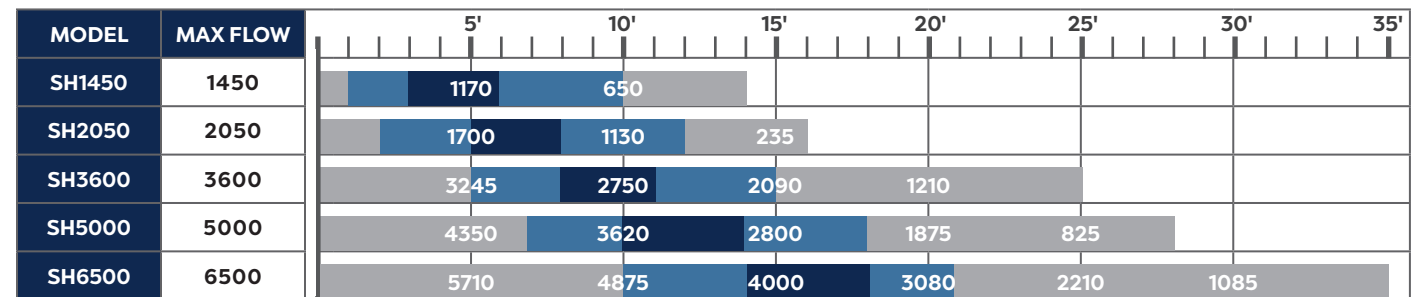

■ Recommended Operating Range
 ■ Best Efficiency Range
 ■ Do Not Operate Range

TIDALWAVE A-SERIES PUMPS



- A-Series Direct Drive pumps are built for the highest head, high volume applications, to tackle the longest runs and tallest falls
- A-Series pumps feature heavy-duty cast iron and stainless steel housing for years of dependable service
- Continuous duty Direct Drive motors reduce maintenance to simply keeping the intake screen clean
- Double silicone carbide mechanical seals and dual drive bearings reduce friction and wear, prolonging motor life
- Thermal overload protection shuts down pump in low water conditions, to prevent serious damage due to overheating

| MODEL | ITEM | LIST | MOTOR | VOLTS | AMPS | WATTS | OUTLET | WEIGHT | CORD | DIMENSIONS | WARRANTY |
|-------|-------|------------|--------|-------|------|-------|---------|---------|------|-----------------------|----------|
| A-05 | 73892 | \$568.99 | 1/2 HP | 115 | 5.4 | 645 | 2" FIPT | 32 lbs. | 30' | 9"L x 6 1/4"W x 15"H | 2-year |
| A-05L | 73893 | \$694.99 | 1/2 HP | 115 | 6.4 | 725 | 2" FIPT | 40 lbs. | 30' | 10"L x 7"W x 17"H | 2-year |
| A-21 | 73894 | \$850.99 | 1 HP | 115 | 10 | 1060 | 2" FIPT | 43 lbs. | 30' | 10"L x 7"W x 17"H | 2-year |
| A-31 | 73895 | \$941.99 | 1 HP | 115 | 10 | 1160 | 3" FIPT | 48 lbs. | 30' | 11"L x 7"W x 18"H | 2-year |
| A-32 | 73896 | \$1,503.99 | 2 HP | 230 | 9.6 | 2055 | 3" FIPT | 95 lbs. | 30' | 15"L x 8 1/2"W x 23"H | 2-year |

| MODEL | MAX FLOW | 5' | 10' | 15' | 20' | 25' | 30' | 35' | 40' | 45' | 50' | 55' | 60' |
|-------|----------|-------|-------|-------|------|------|------|------|------|------|------|------|-----|
| A-05 | --- | 3165 | 2840 | 2500 | 2155 | 1875 | 1455 | 935 | 320 | | | | |
| A-05L | --- | 5040 | 4320 | 3600 | 2820 | 1920 | 840 | | | | | | |
| A-21 | --- | 5810 | 5325 | 4824 | 4335 | 3770 | 3140 | 2400 | 1530 | 540 | | | |
| A-31 | --- | 9300 | 8150 | 6830 | 5535 | 4120 | 2535 | 625 | | | | | |
| A-32 | --- | 12000 | 11040 | 10440 | 9780 | 9000 | 8280 | 7560 | 6780 | 5580 | 4920 | 3890 | |

Recommended Operating Range Best Efficiency Range Do Not Operate Range

TIDALWAVE L-SERIES PUMPS



- L-Series Direct Drive Axial pumps economically deliver very high volumes of water at low head through large diameter plumbing for wide waterfalls or where massive flows are required
- L-Series Direct Drive Axial pumps feature 3-inch male threaded outlets for ease in plumbing large diameter tubing
- Heavy-duty cast iron and stainless steel housing ensures years of dependable service
- Dual drive bearings and double silicone carbide mechanical seals reduce friction and wear, prolonging motor life
- Thermal overload protection shuts down pump in low water conditions, to prevent serious damage due to overheating

| MODEL | ITEM | LIST | HP | VOLTS | AMPS | WATTS | OUTLET | WEIGHT | CORD | DIMENSIONS | WARRANTY |
|-------|-------|------------|-----|-------|------|-------|--------|---------|------|----------------------|----------|
| L-305 | 73897 | \$1,503.99 | 1/2 | 115 | 8.0 | 710 | 3" MPT | 60 lbs. | 30' | 9"L x 9"W x 19 1/4"H | 2-year |
| L-310 | 73898 | \$1,647.99 | 1 | 115 | 10 | 1105 | 3" MPT | 65 lbs. | 30' | 9"L x 9"W x 19 1/4"H | 2-year |

| MODEL | MAX FLOW | 5' | 10' | 15' | 20' | 25' | 30' |
|-------|----------|-------|-------|------|------|-----|-----|
| L-305 | 11400 | 10380 | 7380 | 3960 | | | |
| L-310 | 14200 | 13500 | 10560 | 7380 | 3240 | | |

Recommended Operating Range Best Efficiency Range Do Not Operate Range

DID YOU KNOW?



Axial flow pumps work in a different way than centrifugal pumps. Unlike centrifugal pumps that sacrifice flow for pressure, axial pumps accelerate water through the pump without restriction. This gives them the ability to produce tremendous volumes but at very low pressures. Atlantic Axial pumps require large diameter plumbing that reduces friction pressure in order to deliver the massive flows they are capable of.

TIDALWAVE ACCESSORIES

VARIABLE SPEED CONTROLLER

The TidalWave VSC allows you to vary the output of TidalWave TT-Series Asynchronous pumps wirelessly by remote control or mobile app! The VSC allows you to set both on and off times as well as adjust pump from max flow down to 25% in 10 levels of adjustment, giving you the ultimate control over water flow.

- Unlike integrated variable speed controllers, where any failure of pump or controller renders everything non-operational, our Variable Speed Controller operates separately from the pump

- The LCD screen on the control panel displays time of day and flow levels, and accesses programmable on/off timer
- The VSC will retain the flow level and programmed on/off times even in the event of power loss
- Cord lock function eliminates inadvertent plug disconnection
- Rugged weatherproof housing allows you to mount the control box outdoors near your pump
- Great for routine maintenance and feeding fish



Weatherproof output port locks pump cord in place.



| MODEL | ITEM | LIST | CORD | FOR USE WITH | DIMENSIONS | INCLUDES | WARRANTY |
|-------|-------|----------|------|--------------------------|-----------------|-----------------------|----------|
| TWVSC | 73933 | \$178.99 | 6' | TT Pumps up to 800 watts | 6"H x 4"L x 2"W | 2.4GHz Remote Control | 3-year |



Download our new TidalWave VSC app on the App Store and Google Play to wirelessly control your Variable Speed Controller from your smartphone or tablet.

- All TidalWave Variable Speed Controllers are compatible with the TidalWave VSC app
- The VSC app allows you to adjust the flow and power on/off your VSC



- Customize network name and password for secure access
- Effortlessly switch between multiple VSCs in Wi-Fi settings to control different water features
- Available for both Android™ and Apple® smartphones and tablets

DID YOU KNOW?

It's simple to control multiple pumps via the TidalWave VSC mobile application. Give each VSC its own specific network name and password under "Login Settings" in the drop down menu of the app. Switch between the different Wi-Fi networks to control each one independently.



TELESCOPING FOUNTAIN HEADS

Add another dimension to your water garden with Atlantic's Fountain Heads. Compatible with all of Atlantic's MD-Series Pumps, these versatile Fountain Heads pivot to make leveling easy, telescope to adjustable heights and feature four different spray patterns to choose from.



MDFH2575

MDFH1020



Fountain Heads are compatible with TidalWave MD-Series Pumps on page 71

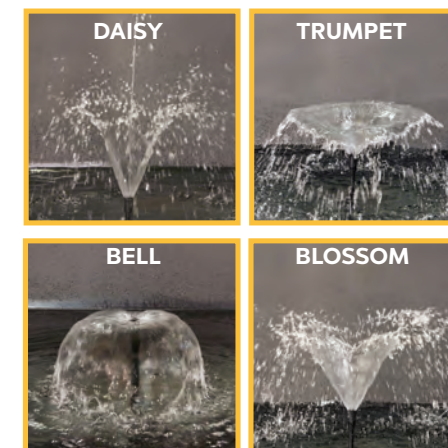

| MODEL | ITEM | LIST | MIN HEIGHT | MAX HEIGHT | INLET | OUTLET | FOR USE WITH | INCLUDES | WARRANTY |
|----------|-------|---------|------------|------------|-----------|-------------|--------------|---|----------|
| MDFH2575 | 73835 | \$19.99 | 12" | 18" | 3/4" FIPT | 1/2" Insert | MD250-750 | Telescoping diverter w/ 4 interchangeable heads | 1-year |
| MDFH1020 | 73834 | \$27.99 | 15" | 22" | 1" FIPT | 1" MIPT | MD1000-1500 | Telescoping diverter w/ 4 interchangeable heads | 1-year |

PUMP PROTECTOR

- The number one cause of Direct Drive pump failure is overheating, often caused by voltage spikes, brownouts, running while not fully submerged or while blocked
- Regardless of the cause, Atlantic's Pump Protector will automatically shut off Direct Drive pumps before they can be damaged
- The Pump Protector electronically monitors power fluctuation caused by adverse running conditions
- When the current change exceeds either of two pre-set levels, power to the Direct Drive pump is cut off until physically reset, no cycling on and off, no overheating
- The Pump Protector installs and calibrates easily to all 120V Direct Drive pumps drawing up to 14 Amps
- Protects TidalWave SH-, PAF-, A- and L-Series Direct Drive pumps against operating dry, current spikes, current drop, thermal cycling and low water flow



| MODEL | ITEM | LIST | INPUT | MAX AMPS | FOR USE WITH | WARRANTY |
|--------|-------|----------|-------------|----------|---|----------|
| TWPP14 | 73932 | \$203.99 | 120 volt AC | 14 | SH-, PAF-, A- and L-Series Direct Drive Pumps | 1-year |

DID YOU KNOW?

Unlike water level sensors and built-in thermal protectors, which allow pumps to repeatedly overheat, the TidalWave Pump Protector electronically monitors power fluctuation caused by adverse running conditions. When the current change exceeds either of two pre-set levels, power to the Direct Drive pump is cut off until the Pump Protector is physically reset, no cycling on and off, no overheating.



FOUNTAIN PUMPS



45417

45414



- Magnetic Induction fountain pumps offer high efficiency and low power consumption in a small form factor
- OASE Fountain Pumps are ideal for use in small garden, wall and table top fountain applications
- With built-in adjustable flow control, suction cups for stabilization and grounding plate for an added measure of protection
- Removable filter foam protects rotor and impeller from wear
- Includes fittings to accept OASE Kink-free hose
- Energy efficient motors keep operating costs to a minimum
- Replaceable components assure a long service life
- Accessorize with OASE 4-pattern Nozzle Set for added visual interest page 18



| ITEM | LIST | DESCRIPTION | VOLTS | WATTS | CORD | DIMENSIONS | HOSE SIZE | WARRANTY |
|-------|---------|-------------------|-------|-------|------|--------------------|------------|----------|
| 45417 | \$18.99 | Fountain Pump 90 | 120 | 4 | 6' | 3"L x 1½"W x 2¼"H | ⅝", ½" | 3-year |
| 45413 | \$20.99 | Fountain Pump 150 | 120 | 7 | 6' | 3½"L x 1¼"W x 2½"H | ⅝", ½" | 3-year |
| 45414 | \$32.99 | Fountain Pump 320 | 120 | 23 | 16' | 4"L x 2"W x 3"H | ½", ¾" | 3-year |
| 45416 | \$45.99 | Fountain Pump 525 | 120 | 42 | 16' | 4½"L x 2½"W x 3½"H | ½", ⅝", ¾" | 3-year |

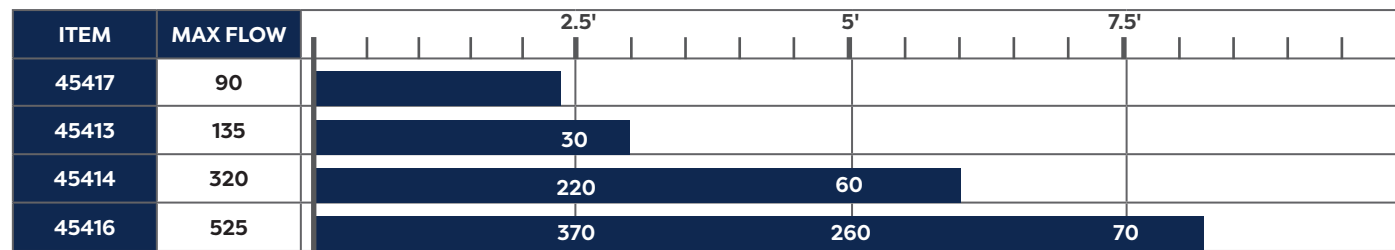

NEPTUN



- Asynchronous fountain pumps are ideal for larger fountains, bubblers and nozzles
- OASE Neptun Pumps offer extraordinary construction and a stable platform for your most exacting fountain applications
- Stainless steel intake screen with large surface area resists clogging for dependable low maintenance performance
- Frost proof down to -4°F for extreme durability
- Integrated thermal protection and grounding plate for unparalleled safety
- Adjustable flow control and rotatable intake for use in shallow water applications
- Inline capable for remote placement outside of water reservoir
- Compact design with removable wide stable base for versatility in multiple applications
- Use OASE Nozzle Extension to extend nozzle height from 11" - 22"
- Includes 1½" x 1"/1¼"/1½" metric step, 1" x ¾"/1"/1¼" metric step, 1" slip x FIPT, 1½" slip x FIPT, 1" FIPT coupling fittings

| ITEM | LIST | DESCRIPTION | VOLTS | AMPS | WATTS | CORD | DIMENSIONS | HOSE SIZE | WARRANTY |
|-------|----------|-------------|-------|------|-------|------|--------------------|-----------------|----------|
| 57394 | \$368.99 | Neptun 1600 | 120 | 0.8 | 100 | 20' | 19"L x 8½"W x 8"H | ¾", 1", 1¼" 1½" | 5-year |
| 57096 | \$501.99 | Neptun 2600 | 120 | 1.9 | 220 | 20' | 21"L x 9¾"W x 8¾"H | ¾", 1", 1¼" 1½" | 5-year |

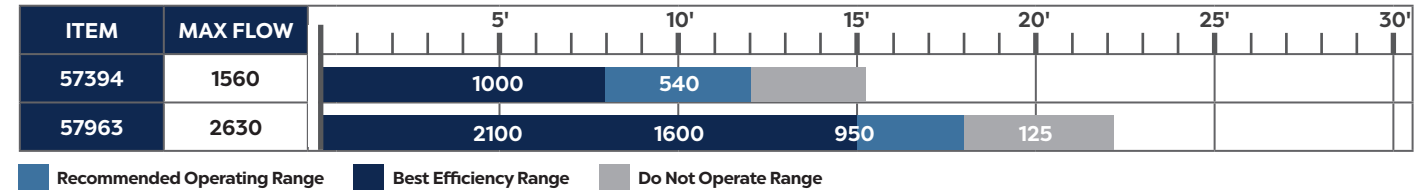



AQUARIUS ECO-EXPERT



58978



- Brushless DC pumps are powerful, energy efficient filtration pumps for demanding filter systems and fountains
- OASE Aquarius Eco Expert are next generation pumps outstanding for their extremely powerful and economical water delivery
- Robust stainless steel intake screen passes debris particles up to 3/16"
- Unique patented frost protection safeguards pump from freeze damage down to -4°F
- Integrated Environmental Function Control automatically shuts off the pump in run dry conditions to prevent motor damage
- Dynamic Function Control (DFC) offers 1 preprogrammed scene, alternating fountain heights, without additional controller; when connected to EGC Dynamic Function Control offers 11 additional preprogrammed scenes
- Submersed or inline installation in a variety of water types, including chlorinated pool and salt water, see page 83
- Can be regulated and operated remotely either by Eco Control or EGC Controller Cloud
- Integrated grounding plate for unparalleled safety
- Unlike direct drive pumps which are susceptible to suction cavitation and pump damage, the AquaMax Eco Expert has no minimum operating head height
- Qualifies for the OASE Clear Water Guarantee when paired with the proper pump and UVC Clarifier, see page 161
- Includes Sch40 adapter for 1½" and 2" tubing

| ITEM | LIST | DESCRIPTION | VOLTS | AMPS | WATTS | OUTLET | CORD | DIMENSIONS | OUTLET FITTING | WARRANTY |
|-------|------------|---------------------------|------------------------|------|-------|--------|------|--------------------|------------------------|----------|
| 57964 | \$1,480.99 | Aquarius Eco Expert 7300 | 220 - 240 V / 50-60 Hz | 2 | 440 | 2" | 33' | 19"L x 8½"W x 8"H | Sch40 1½" - 2" adapter | 5-year |
| 58978 | \$2,278.99 | Aquarius Eco Expert 11500 | 220 - 240 V / 50-60 Hz | 3.5 | 700 | 2" | 33' | 21"L x 9¾"W x 8¾"H | Sch40 1½" - 2" adapter | 5-year |

| MODEL | MAX FLOW | 5' | 10' | 15' | 20' | 25' | 30' | 35' |
|-------|----------|-------|------|------|------|------|------|-----|
| 57964 | 7300 | 6700 | 5825 | 4800 | 3900 | 2825 | 1150 | |
| 57978 | 11500 | 10300 | 8700 | 7310 | 5560 | 3800 | 2100 | |

AQUARIUS ECO EXPERT FEATURES:

1. Ergonomic handle aligns with the pump's center of gravity
2. Integrated mounting holes in the base enable fixed installation
3. Rotatable volute handles multiple configurations
4. Robust stainless steel intake screen prevents debris entering
5. Dynamic Flow Control (DFC) switch enables 1 preprogrammed water pattern
6. Grounding plate safeguards against short circuits anywhere in the water feature
7. EGC connections provide input/output to an additional 9 devices, remotely from anywhere in the world



ACCEPTABLE WATER QUALITY RANGE

| | pH VALUE | HARDNESS | FREE CHLORINE | CHLORIDE CONTENT | SALT CONTENT | OVERALL DRY RESIDUE | TEMPERATURE |
|------------|-----------|---------------|---------------|------------------|--------------|---------------------|-------------|
| FRESHWATER | 6.8 - 8.5 | 142 - 267 ppm | <0.3 ppm | <250 ppm | <0.4% | <50 ppm | 39° - 95°F |
| POOLWATER | 7.2 - 8.3 | 142 - 267 ppm | <0.6 ppm | <250 ppm | <0.4% | <50 ppm | 39° - 86°F |
| SALTWATER | 7.2 - 8.5 | 256 - 534 ppm | <0.3 ppm | <22000 ppm | <4.0% | <50 ppm | 39° - 82°F |

CONTROLLERS

The Aquarius Eco Expert has two options to remotely control the pump

ECO CONTROL*

Eco Control is an innovative controller that directly connects to the pump to regulate all functions, with an easy-to-read illuminated two-line display. See page 89 for more information on the Eco Control.



Eco Control

The Eco Control standalone controller regulates the following functions:

- Dynamic Function Control (DFC) of expanded library of 12 pre-programmed water patterns
- Complete adjustment of output flow
- Power consumption read-out
- Displays pump status and malfunctions
- Rotation speeds
- Total runtime

*Not useable if the pump is connected to an EGC network

EASY GARDEN CONTROL (EGC)

Connect your Aquarius Eco Expert to the Easy Garden Control (EGC) to fully control the pump from anywhere in the world on any Android or Apple Device with EGC mobile application. See page 5 for more information on the EGC System.

The EGC can display and control a variety of functions including:

- Dynamic Function Control (DFC) of expanded library of 12 pre-programmed water patterns
- Complete adjustment of output flow
- Displays:
 - Operation status
 - Water temperature
 - Power consumption
 - Overall performance data
 - Performance charts over time



EGC Cloud Controller



AQUAMAX ECO CLASSIC



- Synchronous electronic pumps are designed for in-pond applications where debris is delivered through the pump to a filtration system
- OASE AquaMax Eco Classic is an energy efficient, solids handling pump with a large intake pre-filter and Environmental Function Control
- Environmental Function Control (EFC) automatically shuts off the pump if dry run or clogged to prevent pump damage
- Large-surface, wrap-around pre-filter allows coarse debris particles up to 1/8" to pass through pump; may be removed for in-line use
- AquaMax Eco Classic features a coated magnetic rotor for adverse water conditions and proprietary grounding plate for unparalleled safety
- Qualifies for the OASE Clear Water Guarantee when paired with the proper pump and UVC Clarifier, see page 161
- Includes metric pivoting step fittings (1" 1/4", 1 1/2"), and Sch40 1 1/2" / 2" adapter

| ITEM | LIST | DESCRIPTION | VOLTS | AMPS | WATTS | CORD | DIMENSIONS | HOSE SIZE | WARRANTY |
|-------|----------|--------------------------|-------|------|-------|------|----------------------|---------------------|----------|
| 40347 | \$173.99 | AquaMax Eco Classic 1200 | 120 | 1.2 | 45 | 20' | 11"L x 9"W x 5 1/2"H | 1" 1/4", 1 1/2", 2" | 3-year |
| 57620 | \$197.99 | AquaMax Eco Classic 1900 | 120 | 1.3 | 70 | 20' | 11"L x 9"W x 5 1/2"H | 1" 1/4", 1 1/2", 2" | 3-year |
| 57621 | \$234.99 | AquaMax Eco Classic 2700 | 120 | 1.4 | 110 | 20' | 11"L x 9"W x 5 1/2"H | 1" 1/4", 1 1/2", 2" | 3-year |
| 57623 | \$272.99 | AquaMax Eco Classic 3600 | 120 | 1.7 | 150 | 20' | 11"L x 9"W x 5 1/2"H | 1" 1/4", 1 1/2", 2" | 3-year |

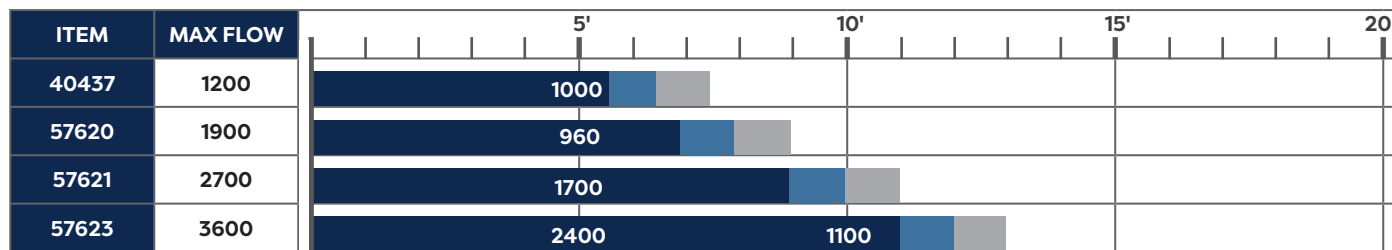

Recommended Operating Range Best Efficiency Range Do Not Operate Range

CLEAR WATER GUARANTEE

| PUMP | FILTER | UVC |
|--------------------------|---|-------------------|
| AquaMax Eco Classic 1200 | BioPress1000 | Included w/Filter |
| AquaMax Eco Classic 1900 | BioPress 1600 / FiltoClear 3000 | Included w/Filter |
| | BioSmart 5000 | Vitronic 18 |
| AquaMax Eco Classic 2700 | BioPress 2400 / FiltoClear 4000 | Included w/Filter |
| | BioSmart 10000 | Vitronic 36 |
| AquaMax Eco Classic 3600 | FiltoClear 8000 | Included w/Filter |
| | BioTec ScreenMatic ² 18000 / 24000 | Bitron C 55 |



AQUAMAX ECO PREMIUM



- Synchronous electronic pumps are designed for in-pond applications where debris is delivered through the pump to a filtration system
- OASE AquaMax Eco Premium is an energy efficient in-pond pump with dual intake capability with adjustable second inlet connecting to optional PS3000 satellite filter or surface skimmer
- Environmental Function Control (EFC) automatically shuts off the pump if dry run or clogged to prevent pump damage
- Large-surface, wrap-around pre-filter passes coarse debris particles up to 3/8"
- Pump can be used in-line by removing pre-filter and using mounting bracket to secure
- AquaMax Eco Premium features a grounding plate for unparalleled safety
- Qualifies for the OASE Clear Water Guarantee when paired with the proper pump and UVC Clarifier, see page 161
- Includes metric pivoting step fittings (1" 1/4", 1 1/2"), and Sch40 1 1/2" / 2" adapter

| ITEM | LIST | DESCRIPTION | VOLTS | AMPS | WATTS | CORD | DIMENSIONS | HOSE SIZE | WARRANTY |
|-------|----------|--------------------------|-------|------|-------|------|---------------------------|---------------------|----------|
| 57499 | \$376.99 | AquaMax Eco Premium 2000 | 120 | 1.4 | 65 | 20' | 13 1/2"L x 11"W x 6 1/2"H | 1" 1/4", 1 1/2", 2" | 5-year |
| 57500 | \$437.99 | AquaMax Eco Premium 3000 | 120 | 1.4 | 110 | 20' | 13 1/2"L x 11"W x 6 1/2"H | 1" 1/4", 1 1/2", 2" | 5-year |
| 57501 | \$498.99 | AquaMax Eco Premium 4000 | 120 | 1.8 | 150 | 20' | 13 1/2"L x 11"W x 6 1/2"H | 1" 1/4", 1 1/2", 2" | 5-year |

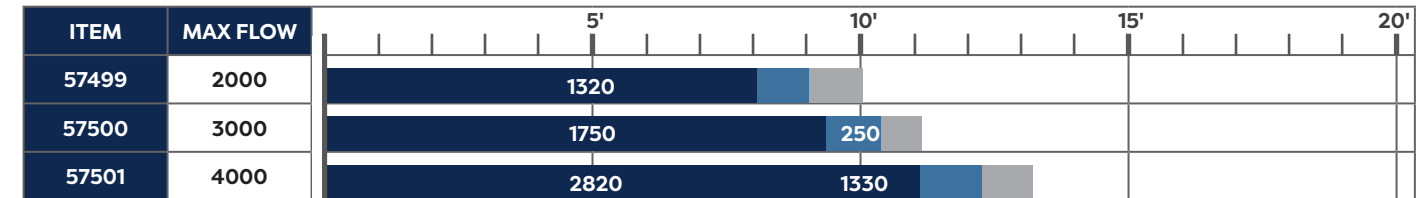

Recommended Operating Range Best Efficiency Range Do Not Operate Range

CLEAR WATER GUARANTEE

| PUMP | FILTER | UVC |
|--------------------------|---|-------------------|
| AquaMax Eco Premium 2000 | BioPress 1600 / FiltoClear 3000 | Included |
| | BioSmart 5000 | Vitronic 18 |
| AquaMax Eco Premium 3000 | BioPress 2400 / FiltoClear 4000 | Included |
| | BioSmart 10000 | Vitronic 36 |
| AquaMax Eco Premium 4000 | FiltoClear 8000 | Included |
| | BioTec ScreenMatic ² 18000/24000 | Bitron C 55 |
| | ProfiClear Premium Compact-M | Bitron C 55 / 110 |
| | ProfiClear Premium Compact-L | Bitron C 110 |



AQUAMAX ECO EXPERT



57963



- Brushless DC pumps are powerful, energy efficient filtration pumps for demanding filter systems and large waterfalls
- OASE AquaMax Eco Expert are next generation pumps outstandingly suited for extremely powerful and economical water delivery
- Robust stainless steel intake screen passes debris particles up to 7/16"
- Unique patented frost protection safeguards pump from freeze damage down to -4°F
- Integrated Environmental Function Control automatically shuts off the pump in run dry conditions to prevent motor damage
- Patented Seasonal Flow Control (SFC) slows water flow, lowers head height and reduces wattage when temperatures drop in response to lower cool season demand, for up to 50% energy savings (optional)
- Submersed or inline installation in a variety of water types, including chlorinated pool and salt water, see page 87
- All functions be regulated and operated remotely by Eco Control and EGC Cloud Controllers
- Unlike direct drive pumps which are susceptible to suction cavitation and pump damage, the AquaMax Eco Expert has no minimum head height for operation
- Includes Sch40 adapter set for 1½" and 2" tubing

| ITEM | LIST | DESCRIPTION | VOLTS | AMPS | WATTS | OUTLET | CORD | DIMENSIONS | OUTLET FITTING | WARRANTY |
|-------|------------|--------------------------|------------------------|------|-------|--------|------|--------------------|------------------------|----------|
| 57875 | \$1,480.99 | AquaMax Eco Expert 6800 | 220 - 240 V / 50-60 Hz | 2 | 440 | 2" | 33' | 19"L x 8½"W x 8"H | Sch40 1½" - 2" adapter | 5-year |
| 57963 | \$2,278.99 | AquaMax Eco Expert 11500 | 220 - 240 V / 50-60 Hz | 3.5 | 700 | 2" | 33' | 21"L x 9¾"W x 8¾"H | Sch40 1½" - 2" adapter | 5-year |

| ITEM | MAX FLOW | 5' | 10' | 15' | 20' | 25' | 30' | 35' |
|-------|----------|-------|------|------|------|------|------|-----|
| 57875 | 6800 | 6100 | 5000 | 4300 | 3250 | 1400 | | |
| 57963 | 11500 | 10000 | 8400 | 6850 | 5350 | 3900 | 1970 | |

CLEAR WATER GUARANTEE

| PUMP | FILTER | UVC |
|--------------------------|--|----------------------------|
| AquaMax Eco Expert 6800 | ProfiClear Premium Compact-M | Bitron C 55 & Bitron C 110 |
| | ProfiClear Premium Compact-L | Bitron C 110 |
| AquaMax Eco Expert 11500 | BioTech ScreenMatic ² 38000 | Bitron C 110 |

*Must adjust flow down to Max flow of filter

AQUAMAX ECO EXPERT FEATURES:

1. Ergonomic handle aligns with the pump's center of gravity
2. Integrated mounting holes in the base enable fixed installation
3. Rotatable volute handles multiple configurations
4. Robust stainless steel intake screen prevents large debris entering pump
5. Seasonal Flow Control (SFC) switch lowers flow and wattages as water cools to 40°F
6. Grounding plate safeguards against short circuits
7. EGC connections provide input/output to an additional 9 devices, remotely from anywhere in the world



ACCEPTABLE WATER QUALITY RANGE

| | pH VALUE | HARDNESS | FREE CHLORINE | CHLORIDE CONTENT | SALT CONTENT | OVERALL DRY RESIDUE | TEMPERATURE |
|------------|-----------|---------------|---------------|------------------|--------------|---------------------|-------------|
| FRESHWATER | 6.8 - 8.5 | 142 - 267 ppm | <0.3 ppm | <250 ppm | <0.4% | <50 ppm | 39° - 95°F |
| POOLWATER | 7.2 - 8.3 | 142 - 267 ppm | <0.6 ppm | <250 ppm | <0.4% | <50 ppm | 39° - 86°F |
| SALTWATER | 7.2 - 8.5 | 256 - 534 ppm | <0.3 ppm | <22000 ppm | <4.0% | <50 ppm | 39° - 82°F |

CONTROLLERS

The AquaMax Eco Expert has two options to remotely control the pump

ECO CONTROL*

Eco Control is an innovative controller that directly connects to the pump to regulate all functions, with an easy-to-read illuminated two-line display. See page 89 for more information on the Eco Control.

The Eco Control standalone controller regulates the following functions:

- Seasonal Function Control (SFC)
- Complete adjustment of output flow
- Power consumption read-out
- Displays pump status and malfunctions
- Rotation speeds
- Total runtime



Eco Control

*Not useable if the pump is connected to an EGC network

EASY GARDEN CONTROL (EGC)

Connect your AquaMax Eco Expert to the Easy Garden Control (EGC) to fully control the pump from anywhere in the world on any Android or Apple Device with EGC mobile application. See page 5 for more information on the EGC Cloud Controller.

The EGC can display and control a variety of functions including:

- Seasonal Function Control (SFC)
- Complete adjustment of output flow
- Displays:
 - Operation status
 - Water temperature
 - Power consumption
 - Overall performance data
 - Performance charts over time



EGC Cloud Controller

WATERFALL PUMPS

45422



- Synchronous magnetic pumps are specifically designed to create falls in Water Garden and Pond-free applications
- OASE Waterfall Pumps are reliable, energy efficient pumps that excel in hard water conditions
- Grounding plate eliminates any chance of stray current entering water for unparalleled safety
- Coated magnetic rotors are impervious to adverse water conditions
- Self-cooling, debris flushing rotor chambers keep pumps from overheating in the most demanding applications
- Tool-less volute removal makes maintenance fast and easy
- Ergonomic handles align with the pump center of gravity to facilitate transport and installation

| ITEM | LIST | DESCRIPTION | VOLTS | AMPS | WATTS | OUTLET | CORD | DIMENSIONS | OUTLET FITTING | WARRANTY |
|-------|----------|---------------------|-------|------|-------|----------|------|--------------------|----------------|----------|
| 45421 | \$172.99 | Waterfall Pump 1650 | 120 | 0.75 | 70 | 1¼" MIPT | 20' | 8½"L x 5"W x 6¼"H | 1" - 1½" Step | 3-year |
| 45422 | \$225.99 | Waterfall Pump 2300 | 120 | 1.2 | 130 | 1¼" MIPT | 20' | 8½"L x 5"W x 6¼"H | 1" - 1½" Step | 3-year |
| 45423 | \$279.99 | Waterfall Pump 3700 | 120 | 1.5 | 170 | 1½" MIPT | 20' | 9½"L x 5½"W x 6½"H | 1" - 1½" Step | 3-year |
| 45424 | \$320.99 | Waterfall Pump 5150 | 120 | 2.2 | 230 | 2" MIPT | 20' | 9½"L x 5½"W x 6½"H | 1½" - 2" Step | 3-year |

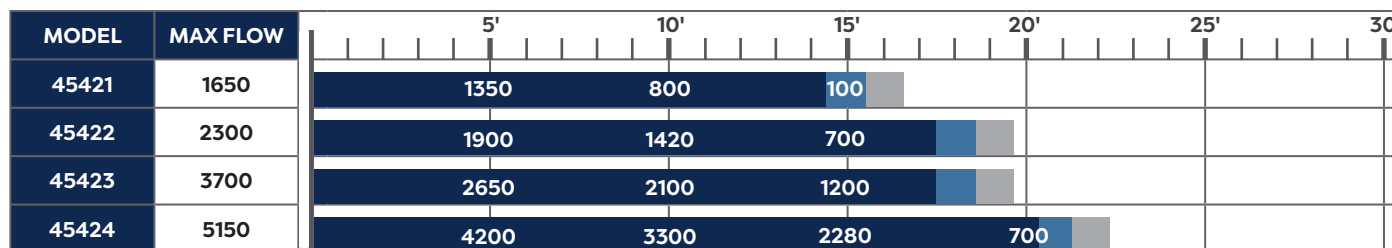

Recommended Operating Range
Best Efficiency Range
Do Not Operate Range

OASE ACCESSORIES

AQUAMAX SATELLITE FILTER



- Compatible with OASE AquaMax Eco Premium Pumps
- Use as a remote bottom drain for increased circulation and debris removal up to ⅜" from an additional area on the pond floor
- Includes metric step fitting (1", 1¼", 1½")

| ITEM | LIST | DESCRIPTION | DIMENSIONS | FOR USE WITH | HOSE SIZE | WARRANTY |
|-------|---------|------------------------------|---------------------|---------------------------|--------------|----------|
| 51074 | \$46.99 | AquaMax Satellite Pre-Filter | 14½"L x 10¼"W x 4"H | AquaMax Eco Premium Pumps | 1", 1¼", 1½" | 1-year |

PUMPSHIELD®



- Extend the service life of your pump and ensure lasting high performance by keeping out large debris
- Simply drop the pump into the PumpShield and deploy
- Durable construction for long service life

| ITEM | LIST | DESCRIPTION | DIMENSIONS | WARRANTY |
|-------|---------|-------------|-------------|----------|
| 45394 | \$12.99 | PumpShield® | 15"L x 15"W | 1-year |

ECO CONTROL



- Innovative controller for smart regulation of Eco Expert Pumps
- Illuminated two-line display for easy read-out
- Displays power consumption, pump status and malfunctions, rotation speeds and total runtime
- Allows remote operation of Seasonal Function Control (SFC) and Dynamic Function Control (DFC)
- Standalone controller needs no external power supply, but cannot be used if the pump is connected to an EGC network

| ITEM | LIST | DESCRIPTION | CORD | DIMENSIONS | FOR USE WITH | WARRANTY |
|-------|----------|-------------|------|--------------------|--|----------|
| 72375 | \$204.99 | Eco Control | 33' | 3¼"L x 3½"W x 1½"H | Aquarius Eco Expert & AquaMax Eco Expert Pumps | 1-year |

I INSTALLATION

Atlantic offers the best of everything you need to install your water features, without ever compromising quality. From innovative products designed with you in mind, like the award-winning Triton Check Valve that works with any pump, skimmer or pump vault, to fittings, foam, tubing and liner all proudly manufactured in the USA, our installation accessories will stand the test of time.

- » Triton Check Valves custom fit every Atlantic application and adapt to all other manufacturers' equipment for the greatest versatility and convenience for the installer
- » Atlantic high density FallsFoam available in gun cartridge and single use cans resists ultraviolet light and weathering for years of dependable service
- » Compact, fully adjustable Automatic Fill Valves install easily to top water off automatically, saving time, trouble and pumps
- » American-made Kink-Free and flex PVC pipe sized for every application have greater flexibility for easier installation
- » Carlisle Aquatough liner with J-Tear technology reduces inadvertent rips and leaks



TRITON CHECK VALVE

- Check Valves mount to the pump in the Skimmer to maintain water in biological filters and keep beneficial bacteria hydrated
- Atlantic's Triton TR215CV Check Valve is the first and only specifically designed for water feature use
- Included adapters accommodate multiple pump, skimmer, vault and plumbing options
- Single unions above and below the check valve speed removal of the valve and pump for servicing, maintenance and winterizing



| MODEL | ITEM | LIST | VALVE DIMENSIONS | INLET | OUTLET | WARRANTY |
|---------|-------|---------|-----------------------------|-------------------|---------------------|----------|
| TR215CV | 74222 | \$74.99 | 5 5/8" L x 3 1/2" W x 10" H | 1 1/2" or 2" MIPT | 1 1/2" or 2" socket | 3-year |

TRITON CHECK VALVE FEATURES:



1. Full flow swing valve with inlet and outlet unions and a replaceable gasket.
2. Includes discharge fittings for 1 1/2" and 2" PVC pipe and 1" - 1 1/2" tapered insert fitting for metric and ASTM standard tubing.
3. Reversible discharge pipe works with all 1 1/2" and 2" discharge TidalWave pumps and Atlantic equipment.
4. Molded "perfect-cut" dimensions to identify proper lengths for Atlantic product and cut-to-fit 7/8" increments on the reverse side.
5. Discharge extension for use with taller Atlantic equipment.
6. Maximum assembled height of 23" from the pump discharge to the center of the outlet. Pipe can be extended to any length using 2" Sch 40 pipe and fittings.

AWGCV30

- Asymmetrical valve body fits vertical pumps with little lateral clearance
- Rubber coupling simplifies pump and valve removal for servicing, maintenance and winterizing
- Can be extended to any height using 3" Sch 40 pipe and fittings
- Full flow flap design reduces friction losses and increases flow



| MODEL | ITEM | LIST | VALVE DIMENSIONS | INLET | OUTLET | WARRANTY |
|---------|-------|----------|----------------------------------|-----------|--------------------|----------|
| AWGCV30 | 74220 | \$161.99 | 11 1/2" L x 5 1/2" W x 13 1/2" H | 3" socket | 3" rubber coupling | 3-year |



INSTALLATION PRODUCTS

FALLSFOAM



LF1100

LF1300

LF1325

- FallsFoam fills voids and keeps water flowing on top of waterfall rocks instead of under them
- Atlantic's high density closed cell FallsFoam resists foot traffic and waterlogging
- Black for lower visibility, FallsFoam resists UV deterioration and lasts for years
- Foam Cleaner quickly dissolves uncured foam to keep guns and surroundings clean

| MODEL | ITEM | LIST | DESCRIPTION | FOR USE WITH | SIZE | WARRANTY / SHELF LIFE |
|--------|-------|---------|--|--------------|--------|--------------------------|
| LF1100 | 74198 | \$14.99 | DIY Black Waterfall Foam Can w/ applicator straw | --- | 12 oz. | 1 year from Born on Date |
| LF1300 | 74199 | \$28.99 | Professional Black Waterfall Gun Foam | Foam Guns | 29 oz. | 1 year from Born on Date |
| LF1325 | 74203 | \$22.99 | Foam Gun Cleaner Can w/ optional spray nozzle | Foam Guns | 12 oz. | 1-year |

FALLSFOAM GUNS



LF1315

LF1310

- Foam Guns feature a 7" barrel length for hard to reach areas
- Durable solvent resistant construction
- Adjustable nozzle to control bead width

| MODEL | ITEM | LIST | DESCRIPTION | FOR USE WITH | WARRANTY |
|--------|-------|----------|----------------------------------|--------------|----------|
| LF1315 | 74201 | \$55.99 | Professional Foam Gun, Composite | 29 oz. cans | 1-year |
| LF1310 | 74200 | \$202.99 | Professional Foam Gun, Alloy | 29 oz. cans | 1-year |

FLEXIBLE PVC PIPE

Atlantic's top quality, American made Schedule 40 PVC pipe is heavy-walled, extremely flexible and incredibly durable. Decrease labor and maximize pump flow with Flexible PVC Pipe.

| MODEL | ITEM | LIST | SIZE | WEIGHT | WARRANTY |
|----------|-------|----------|--------------------------------|---------|----------|
| FH1525 | 75251 | \$49.99 | 1½" x 25' PVC Black Flex Pipe | 13 lbs. | 5-year |
| FH1550 | 75252 | \$96.99 | 1½" x 50' PVC Black Flex Pipe | 26 lbs. | 5-year |
| FH225 | 75253 | \$71.99 | 2" x 25' PVC Black Flex Pipe | 18 lbs. | 5-year |
| FH250 | 75254 | \$133.99 | 2" x 50' PVC Black Flex Pipe | 36 lbs. | 5-year |
| FH350 | 75255 | \$307.99 | 3" x 50' PVC Black Flex Pipe | 70 lbs. | 5-year |
| KF.75100 | 75250 | \$119.99 | ¾" x 100' PVC Kink-Free Tubing | 11 lbs. | 1-year |



AUTO FILL

Atlantic's AF1000 Automatic Fill Valve maintains a consistent water level in all Atlantic Skimmers, Pump Vaults, Formal Spillway Basins and Fountain Basins.

- Includes fittings to connect to a water supply using standard garden hose, ½" irrigation line and ½" Sch 40 PVC
- Supplies 1.5 gallons per minute at up to 80 psi

| MODEL | ITEM | LIST | DESCRIPTION | WARRANTY |
|--------|-------|---------|-----------------------|----------|
| AF1000 | 74246 | \$34.99 | ½" MIPT Auto Fill Kit | 1-year |



RTV SILICONE SEALANT

Black RTV Silicone Sealant is used to create a watertight seal where liner is attached to filtration components. RTV Silicone used in conjunction with Atlantic's molded inserts, liner retention flanges and stainless steel hardware ensures a watertight connection every time.

- Atlantic's Room Temperature Vulcanization formula cures quickly for a permanent flexible seal
- Available in both small tube and gun cartridge sizes

| MODEL | ITEM | LIST | DESCRIPTION | SIZE | SHELF LIFE |
|---------|-------|---------|------------------------------|----------|---------------------------|
| SN2800 | 74247 | \$7.99 | Black RTV Silicone Tube | 2.8 oz. | 2 years from Born on Date |
| SN10300 | 74248 | \$15.99 | Black RTV Silicone Cartridge | 10.3 oz. | 2 years from Born on Date |



SPECIALTY FITTINGS

- Atlantic's polypropylene bulkhead fittings install in flexible and rigid reservoir walls to create secure plumbing connections with standard Schedule 40 PVC fittings
- Reverse threaded bulkhead fittings tighten as standard fittings are screwed into them
- Cord Seal Fitting with expanding rubber core fits inside 1½" socket fittings to create a leak-proof seal around ¼" - ¾" cords
- Cord Seal Fitting is used to pass pump and lighting cords in underwater bulkhead or conduit connections through reservoir walls



| MODEL | ITEM | LIST | DESCRIPTION | DIMENSIONS | HOLE SIZE |
|---------|-------|---------|--------------------------------|-------------|---------------------------|
| HA1550 | 74223 | \$18.99 | Bulkhead (1½" FIPT x 1½" FIPT) | 4½"W x 2¾"H | 3" |
| HA2000 | 74224 | \$18.99 | Bulkhead (2" FIPT x 2" FIPT) | 4½"W x 2¾"H | 3" |
| HA3000 | 74225 | \$56.99 | Bulkhead (3" FIPT x 3" FIPT) | 5½"W x 2½"H | 4½" |
| CSEAL15 | 74205 | \$19.99 | Cord Seal Fitting (1½" spigot) | 1¾"W x 1¾"H | 1½" Sch 40 socket fitting |



EPDM LINER & ACCESSORIES

Atlantic-OASE offers the finest underlayment, liner and accessories, including genuine Carlisle AquaTough 45mil EPDM Liner. Available boxed for convenience and in rolls for larger projects, American made Carlisle liner is the highest quality available. Carlisle liner features its exclusive J-Tear technology, a unique manufacturing process that turns tears on themselves to reduce the chance of ripping in the field.



UNDERLAYMENT

4 oz. non-woven polypropylene fabric protects liner against cuts, roots and abrasion.

| MODEL | ITEM | LIST | SIZE | DESCRIPTION |
|---------|-------|----------|------------|--|
| PU1212 | 74147 | \$49.99 | 12' x 12' | Pond Underlayment (single bag) |
| PU1225 | 74148 | \$89.99 | 12' x 25' | Pond Underlayment (single bag) |
| PU12100 | 74146 | \$305.99 | 12' x 100' | Pond Underlayment (full roll w/ 6' core) |



LINER ACCESSORIES

Seam Tape and Primer work together to create watertight seams and repair inadvertant rips and tears.

| MODEL | ITEM | LIST | SIZE | DESCRIPTION |
|-----------------|-------|----------|------------------------|---|
| LI SEAMTAPE3 | 74184 | \$211.99 | 3" x 100' | Double-Sided Seam Tape |
| LI SEAMTAPE6 | 74185 | \$554.99 | 6" x 100' | Single-Sided Cover Tape |
| LI PRIMERQT | 74196 | \$26.99 | 1 quart | Multi-Purpose Primer* |
| LI PRIMERQT-L | 74197 | \$64.99 | 1 quart | Low VOC Multi-Purpose Primer* |
| LI PRIMERGAL | 74194 | \$69.99 | 1 gallon | Multi-Purpose Primer* |
| LI PRIMERGAL-L | 74195 | \$171.99 | 1 gallon | Low VOC Multi-Purpose Primer |
| LI REPAIRKIT-SM | 74183 | \$76.99 | Small Liner Repair Kit | Pint of Multi-Purpose Primer*, (2) 7" x 9" Peel & Stick Patches, Seam Roller, Scotch-Brite Pad & gloves |



*Primer sales restricted in certain states

BOXED LINER

| MODEL | ITEM | SIZE | BOX DIMENSIONS | WEIGHT | WARRANTY |
|----------|-------|-----------|-----------------|----------|------------------|
| LI810-B | 74193 | 8' x 10' | 12" x 12" x 13" | 27 lbs. | Limited Lifetime |
| LI1010-B | 74186 | 10' x 10' | 12" x 12" x 13" | 33 lbs. | Limited Lifetime |
| LI1015-B | 74187 | 10' x 15' | 12" x 12" x 13" | 48 lbs. | Limited Lifetime |
| LI1515-B | 74188 | 15' x 15' | 12" x 24" x 13" | 71 lbs. | Limited Lifetime |
| LI1520-B | 74189 | 15' x 20' | 12" x 24" x 13" | 94 lbs. | Limited Lifetime |
| LI1525-B | 74190 | 15' x 25' | 12" x 36" x 13" | 117 lbs. | Limited Lifetime |
| LI2020-B | 74191 | 20' x 20' | 12" x 36" x 13" | 119 lbs. | Limited Lifetime |
| LI2025-B | 74192 | 20' x 25' | 12" x 36" x 13" | 150 lbs. | Limited Lifetime |



ROLLED LINER

| MODEL | ITEM | SIZE | CORE SIZE | WEIGHT | WARRANTY |
|------------|-------|-----------------------|--------------------------|-----------|------------------|
| LI R2030 | 74158 | 20' x 30' EPDM Liner | 6" Diameter - 6.5' Long | 180 lbs. | Limited Lifetime |
| LI R2525 | 74162 | 25' x 25' EPDM Liner | 6" Diameter - 6.5' Long | 188 lbs. | Limited Lifetime |
| LI R2530 | 74163 | 25' x 30' EPDM Liner | 6" Diameter - 6.5' Long | 225 lbs. | Limited Lifetime |
| LI R3030 | 74167 | 30' x 30' EPDM Liner | 6" Diameter - 6.5' Long | 270 lbs. | Limited Lifetime |
| LI R1050 | 74151 | 10' x 50' EPDM Liner | 6" Diameter - 6.5' Long | 145 lbs. | Limited Lifetime |
| LI R1550 | 74154 | 15' x 50' EPDM Liner | 6" Diameter - 6.5' Long | 218 lbs. | Limited Lifetime |
| LI R2050 | 74159 | 20' x 50' EPDM Liner | 6" Diameter - 6.5' Long | 290 lbs. | Limited Lifetime |
| LI R2550 | 74164 | 25' x 50' EPDM Liner | 6" Diameter - 6.5' Long | 365 lbs. | Limited Lifetime |
| LI R3050 | 74168 | 30' x 50' EPDM Liner | 6" Diameter - 6.5' Long | 435 lbs. | Limited Lifetime |
| LI R3550* | 74171 | 35' x 50' EPDM Liner | 6" Diameter - 11' Long | 508 lbs. | Limited Lifetime |
| LI R4050* | 77089 | 40' x 50' EPDM Liner | 6" Diameter - 11' Long | 580 lbs. | Limited Lifetime |
| LI R4550* | 77901 | 45' x 50' EPDM Liner | 6" Diameter - 13.5' Long | 653 lbs. | Limited Lifetime |
| LI R5050* | 76033 | 50' x 50' EPDM Liner | 6" Diameter - 13.5' Long | 725 lbs. | Limited Lifetime |
| LI R5100 | 76034 | 5' x 100' EPDM Liner | 6" Diameter - 6.5' Long | 145 lbs. | Limited Lifetime |
| LI R10100 | 77085 | 10' x 100' EPDM Liner | 6" Diameter - 6.5' Long | 290 lbs. | Limited Lifetime |
| LI R15100 | 76021 | 15' x 100' EPDM Liner | 6" Diameter - 6.5' Long | 435 lbs. | Limited Lifetime |
| LI R20100 | 76023 | 20' x 100' EPDM Liner | 6" Diameter - 6.5' Long | 580 lbs. | Limited Lifetime |
| LI R25100 | 76026 | 25' x 100' EPDM Liner | 6" Diameter - 6.5' Long | 725 lbs. | Limited Lifetime |
| LI R30100 | 76028 | 30' x 100' EPDM Liner | 6" Diameter - 6.5' Long | 870 lbs. | Limited Lifetime |
| LI R35100* | 76030 | 35' x 100' EPDM Liner | 6" Diameter - 11' Long | 1015 lbs. | Limited Lifetime |
| LI R40100* | 76031 | 40' x 100' EPDM Liner | 6" Diameter - 11' Long | 1160 lbs. | Limited Lifetime |
| LI R45100* | 77090 | 45' x 100' EPDM Liner | 6" Diameter - 13.5' Long | 1320 lbs. | Limited Lifetime |
| LI R50100* | 76032 | 50' x 100' EPDM Liner | 6" Diameter - 13.5' Long | 1450 lbs. | Limited Lifetime |
| LI R10200* | 75150 | 10' x 200' EPDM Liner | 6" Diameter - 13.5' Long | 580 lbs. | Limited Lifetime |
| LI R15200* | 74153 | 15' x 200' EPDM Liner | 6" Diameter - 13.5' Long | 870 lbs. | Limited Lifetime |
| LI R20200* | 74156 | 20' x 200' EPDM Liner | 6" Diameter - 13.5' Long | 1160 lbs. | Limited Lifetime |
| LI R25200* | 74161 | 25' x 200' EPDM Liner | 6" Diameter - 13.5' Long | 1440 lbs. | Limited Lifetime |
| LI R30200* | 74166 | 30' x 200' EPDM Liner | 6" Diameter - 13.5' Long | 1730 lbs. | Limited Lifetime |
| LI R35200* | 74170 | 35' x 200' EPDM Liner | 6" Diameter - 13.5' Long | 2000 lbs. | Limited Lifetime |
| LI R40200* | 74173 | 40' x 200' EPDM Liner | 6" Diameter - 13.5' Long | 2280 lbs. | Limited Lifetime |
| LI R45200* | 74176 | 45' x 200' EPDM Liner | 6" Diameter - 13.5' Long | 2560 lbs. | Limited Lifetime |
| LI R50200* | 74179 | 50' x 200' EPDM Liner | 6" Diameter - 13.5' Long | 2850 lbs. | Limited Lifetime |

*Must be purchased on a full truckload

FITTINGS & TUBING

TRADUX

- OASE Tradux is a bulkhead fitting assembly with accessories to pass tubing or cables through a reservoir wall
- Passes tubing or cords underwater through pond liner or pre-formed pond walls
- Underwater connections keep water features aesthetically seamless and organic
- Easy installation with just a screwdriver
- Includes two metric step fittings (¾", 1", 1¼", 1½", 2"), bulkhead fitting and cord seal fitting



| ITEM | LIST | HOSE SIZE | WARRANTY |
|-------|---------|----------------------|----------|
| 42750 | \$34.99 | ¾", 1", 1¼", 1½", 2" | 2-year |

FLOW REGULATOR

- OASE Flow Regulator controls water flow to filters and water features
- Use as a tubing connector for connecting non-kink spiral tubing
- Includes valve body and two metric step fittings (1", 1¼", 1½")



| ITEM | LIST | OUTLET | HOSE SIZE | WARRANTY |
|-------|---------|----------|--------------|----------|
| 51260 | \$33.99 | 1" - 1½" | 1", 1¼", 1½" | 1-year |

DID YOU KNOW?

The Tradux fitting can be used either to pass tubing through the liner of a pond or water feature or, with the included cord accessory to pass electrical cords, such as those of pumps or lights, through the liner.

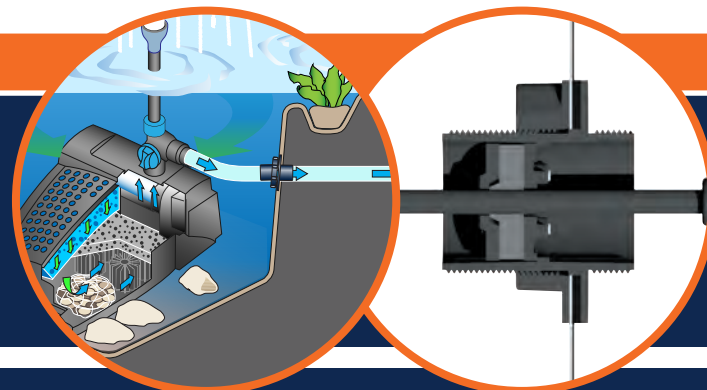

Y-DIVERTER

- OASE Y-Diverter splits the flow from a single source into two valved outlets
- Flow distribution can be individually regulated with integrated valves
- Includes two outlet metric step fittings (¾", 1" 1¼", 1½", 2"), outlet metric step fitting (1", 1¼", 1½") and valve body



| ITEM | LIST | HOSE SIZE | WARRANTY |
|-------|---------|---------------------|----------|
| 51261 | \$46.99 | ¾", 1" 1¼", 1½", 2" | 1-year |

MULTI WD 1"

- OASE Multi WD 1" distributes water flow to up to 3 outlets
- All three outlets feature integrated flow controls
- For use with only two outlets use the included cap to seal off the third outlet



| ITEM | LIST | INLET | OUTLET | WARRANTY |
|-------|---------|------------------|--------|----------|
| 46980 | \$14.99 | ¾", 1", 1½", 1½" | 1" | 1-year |

OASE KINK-FREE TUBING

UV resistant OASE Metric Kink-Free Tubing accommodates OASE fittings and outlets and can withstand up to 45 psi.



| ITEM | LIST | SIZE | WARRANTY |
|-------|----------|----------------------------|----------|
| 45402 | \$23.99 | ¾" x 20' Kink-Free Tubing | 1-year |
| 45399 | \$29.99 | 1" x 20' Kink-Free Tubing | 1-year |
| 45398 | \$41.99 | 1½" x 20' Kink-Free Tubing | 1-year |
| 45401 | \$131.99 | 2" x 50' Kink-Free Tubing | 1-year |
| 45400 | \$257.99 | 2" x 100' Kink-Free Tubing | 1-year |

OASE VINYL TUBING

OASE Metric Vinyl Tubing handles up to 45 psi and accommodates ½" ID fittings and outlets.



| ITEM | LIST | SIZE | WARRANTY |
|-------|---------|-----------------------|----------|
| 45405 | \$14.99 | ½" x 20' Vinyl Tubing | 1-year |

L LIGHTING

Atlantic's innovative LED Lighting Systems lead the industry with the latest technology, new lights, more color options, upgraded connectors and full-featured mobile applications to put complete control at your fingertips. Choose from a multitude of submersible and external fixtures, Warm White or Color Changing options, application or OASE Cloud-based control with confidence.

- » Atlantic Lighting products are all fully compatible with current and previous generations
- » Solid brass bodies dissipate heat, resist corrosion and provide long lasting, dependable service
- » Silicone gaskets and precision lenses guarantee weatherproof and waterproof performance
- » InfiColor Smart Module handles 120 watts, controls 3 independent illumination zones and is fully programmable via mobile application, controlling colors, timing, sequences, brightness and transitions
- » OASE ProfiLux luminaires connect to the Easy Garden Control system for individual cloud-based control from anywhere on the planet



ATLANTIC LIGHTING SYSTEMS

Atlantic's LED Lighting leads the way, giving you more advanced technology, more versatile fixtures, better quality and greater durability than ever before.

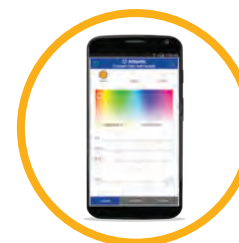

Atlantic delivers the technology you want. The InfiColor Module and mobile application at the heart of the color changing system have the competition playing catchup once again. Leading edge technology provides extraordinary control and convenience, with application-based access to over 16 million colors. Enjoy multiple pre-programmed color sequences or create your own from a limitless palette that can be endlessly customized. Choose from a variety of transitions, that fade, jump, blend and more, to accent your favorite sequences, then save them as you wish. Choose any one, two or all three zones to run the same or contrasting sequences, over multiple sessions, for the ultimate in versatility.



More versatile lighting to meet every need. 2- and 4-watt Spotlights highlight features with a powerful 45-degree beam, staying cooler and lasting longer thanks to innovative driver design and construction. Two sizes of Hardscape Lights accent counters, columns and steps, while the slim profile Bar Light, only 1/2" x 1/2" x 12" long, provides wide yet focused illumination to uplight and downlight walls and waterfalls. 5-watt Ring Lights cast a wide 120-degree cone to illuminate the widest of fountain nozzles with warm white or colored light, or flood the interior of bowls and ponds. Our unique 2-watt Spout Light, the only light that installs inside supply plumbing, creates streams of illuminated water after dark. Our Fountain Lights create liquid torches of light at the tops of basalt columns. Economical Pond Lights with high impact waterproof housings feature all the quality you've come to expect from high end lighting, without the cost.



Quality without compromise. Glass lenses, silicone seals and solid brass construction, accented by a timeless and enduring oil-rubbed finish, ensure long, trouble-free service in or out of water. Superior grade light emitting diodes made by Cree, the American manufacturer that created the warm white LED, safeguard against early failure. Dielectric grease in all connections protects against corrosion and shorting, prolongs service life and comes with every lighting product.





SPOTLIGHTS



WWCS2 (Warm White)
CCCS2 (Color Changing)



WWCS4 (Warm White)
CCCS4 (Color Changing)

- LED Spotlights create focal points in and around the water feature
- Atlantic's compact solid brass Spotlights with oil rubbed bronze finish blend into any landscape or water feature
- Small remote drivers 18" from light decrease heat and pull through 1" sweeps
- Submersible lights function equally well out of water and throughout the landscape
- LED units inside lights are easily replaceable
- Warm White matches 2800° Kelvin temperature of halogen and incandescent lighting
- Spotlights feature 20' power cord and quick-connect plug for easy installation
- Flat 2-wire cord on Warm White can be cut, stripped and tied into existing systems
- InfiColor Smart Module and App (sold separately) unlock the full potential of Color Changing lights
- Color Changing Lights connect to SOL Lighting with included plug adapter

| MODEL | ITEM | LIST | INPUT | WATTS | BEAM ANGLE | DIMENSIONS | INCLUDES | REQUIRES | WARRANTY |
|-------|-------|----------|------------|-------|------------|-------------|---------------------------------------|-------------------------------|----------------|
| WWCS2 | 74106 | \$85.99 | 12 volt AC | 2 | 45 Degrees | 2½"L x 1½"W | Base & ground stake | WW30X4 or 12 volt Transformer | 5-year Limited |
| CCCS2 | 74096 | \$113.99 | InfiColor | 2 | 45 Degrees | 2½"L x 1½"W | Base, ground stake & SOL plug adapter | CCSM30X3 | 5-year Limited |
| WWCS4 | 74107 | \$124.99 | 12 volt AC | 4 | 45 Degrees | 2½"L x 1¼"W | Base & ground stake | WW30X4 or 12 volt Transformer | 5-year Limited |
| CCCS4 | 74097 | \$168.99 | InfiColor | 4 | 45 Degrees | 2½"L x 1¼"W | Base, ground stake & SOL plug adapter | CCSM30X3 | 5-year Limited |



HARDSCAPE LIGHTS



WWHL6 (Warm White)
CCHL6 (Color Changing)



WWHL12 (Warm White)
CCHL12 (Color Changing)

- Hardscape Lights brighten walls, columns or steps evenly, without hot spots
- Atlantic Hardscape Lights of solid brass and stainless steel feature a classic oil rubbed bronze finish to enhance any hardscape
- Hardscape Lights install under steps, caps and counters
- Cast brass epoxied diode assembly can be replaced without removing mounting plate
- Isolated drivers decrease size of fixture and optimize heat dissipation
- Classic oil rubbed bronze finish of Hardscape Lights complements any wall or stairway
- Warm White matches 2800° Kelvin temperature of halogen and incandescent lighting
- Hardscape Lights feature 20' power cord and quick-connect plug for easy installation
- Flat 2-wire cord on Warm White can be cut, stripped and tied into existing systems
- InfiColor Smart Module and App (sold separately) unlock the full potential of Color Changing lights
- Color Changing Lights connect to SOL Lighting with included plug adapter

| MODEL | ITEM | LIST | INPUT | WATTS | BEAM ANGLE | DIMENSIONS | INCLUDES | REQUIRES | WARRANTY |
|--------|-------|----------|------------|-------|-------------|------------------|----------------------------------|-------------------------------|----------------|
| WWHL6 | 74141 | \$124.99 | 12 volt AC | 2 | 120 Degrees | 6"L x ¾"W x ¾"H | Mounting plate | WW30X4 or 12 volt Transformer | 5-year Limited |
| CCHL6 | 74129 | \$168.99 | InfiColor | 2 | 120 Degrees | 6"L x ¾"W x ¾"H | Mounting plate, SOL plug adapter | CCSM30X3 | 5-year Limited |
| WWHL12 | 74140 | \$144.99 | 12 volt AC | 4 | 120 Degrees | 12"L x ¾"W x ¾"H | Mounting plate | WW30X4 or 12 volt Transformer | 5-year Limited |
| CCHL12 | 74128 | \$196.99 | InfiColor | 4 | 120 Degrees | 12"L x ¾"W x ¾"H | Mounting plate, SOL plug adapter | CCSM30X3 | 5-year Limited |

DID YOU KNOW?

The enemy of any Light Emitting Diode (LED) is heat. Because LEDs draw more current as they heat up, they are susceptible to "thermal runaway", where current draw heats up the diode, which draws more current, until the diode burns itself up. The LED driver, a self-contained, regulated DC power source, controls thermal runaway by maintaining constant current. To reduce heat even more, Atlantic has moved the drivers from inside the light to the power cord, to maximize LED lifespan.



TECH TIP

Unlike many built-in fixtures, Atlantic's Hardscape Lights feature a removable LED diode assembly. The assembly attaches with two stainless steel screws, eliminating the need to remove the steel anchor plate to replace the light. Simply loosen the screws and unplug the assembly to remove the old light bar and replace with the new one. Use dielectric silicone grease on the plug to maintain water resistance.

FOUNTAIN LIGHTING



WWRL5 (Warm White)
CCRL5 (Color Changing)

- Low profile Ring Light uplights and washes with an extremely wide 120° beam angle
- Atlantic's solid brass Ring Lights feature a classic oil rubbed bronze finish that complements any landscape or water feature
- Epoxy-encased, cast brass light fits over 1½" pipe and includes bushing for 1" applications
- Warm White matches 2800° Kelvin color temperature of halogens and incandescents
- Ring Lights feature 20' power cord and quick-connect plug for easy installation
- Flat 2-wire cord on Warm White can be cut, stripped and tied into existing systems
- InfiColor Smart Module and App (sold separately) unlock the full potential of Color Changing lights
- Color Changing Lights connect to SOL Lighting with included plug adapter

| MODEL | ITEM | LIST | INPUT | WATTS | BEAM ANGLE | DIMENSIONS | INCLUDES | REQUIRES | WARRANTY |
|-------|-------|----------|------------|-------|-------------|--------------------|-------------------------------|-------------------------------|----------------|
| WWRL5 | 74143 | \$124.99 | 12 volt AC | 5 | 120 Degrees | 3¼"OD x 2"ID x ¾"H | 1" Bushing | WW30X4 or 12 volt Transformer | 5-year Limited |
| CCRL5 | 74132 | \$168.99 | InfiColor | 5 | 120 Degrees | 3¼"OD x 2"ID x ¾"H | 1" Bushing & SOL plug adapter | CCSM30X3 | 5-year Limited |



WWFL2 (Warm White)
CCFL2 (Color Changing)

- Fountain lights illuminate water inside vases, basalts and bubbling boulders
- Atlantic's epoxy-encased Fountain Lights flood plumes of water with 120° beam angle
- PVC body with bottom mounted cord fits into 1½" socket fittings and 2" bore holes
- Fountain Light accepts standard ¾" rigid PVC or Kink-free tubing
- Warm White matches 2800° Kelvin color temperature of halogens and incandescents
- Fountain Lights feature 20' power cord and quick-connect plug for easy installation
- Flat 2-wire cord on Warm White can be cut, stripped and tied into existing systems
- InfiColor Smart Module and App (sold separately) unlock the full potential of Color Changing lights
- Color Changing Lights connect to SOL Lighting with included plug adapter

| MODEL | ITEM | LIST | INPUT | WATTS | BEAM ANGLE | DIMENSIONS | INCLUDES | REQUIRES | WARRANTY |
|-------|-------|---------|------------|-------|-------------|------------|--------------------------------------|-------------------------------|----------------|
| WWFL2 | 74137 | \$49.99 | 12 volt AC | 2 | 120 Degrees | 2"W x 1¾"H | ¾" insert fitting | WW30X4 or 12 volt Transformer | 5-year Limited |
| CCFL2 | 74127 | \$66.99 | InfiColor | 2 | 120 Degrees | 2"W x 1¾"H | ¾" insert fitting & SOL plug adapter | CCSM30X3 | 5-year Limited |

SPECIALTY LIGHTING



WWSL2 (Warm White)
CCSL2 (Color Changing)

- Spout Lights illuminate water flowing from Wall Spouts and bubbling boulders
- Atlantic's Spout Light with 1" MIPT machined brass body mounts inside Sch 40 PVC FIPT fittings to light the stream of water from inside plumbing
- Small diameter drivers are isolated 18" from light for optimal heat dissipation and fit through 1" conduit
- LED units inside lights are easily replaceable
- Warm White matches 2800° Kelvin temperature of halogen and incandescent lighting
- Spout Lights feature 20' power cord and quick-connect plug for easy installation
- Flat 2-wire cord on Warm White can be cut, stripped and tied into existing systems
- InfiColor Smart Module and App (sold separately) unlock the full potential of Color Changing lights
- Color Changing Lights connect to SOL Lighting with included plug adapter

| MODEL | ITEM | LIST | INPUT | WATTS | BEAM ANGLE | DIMENSIONS | INCLUDES | REQUIRES | WARRANTY |
|-------|-------|----------|------------|-------|------------|--------------------|------------------|-------------------------------|----------------|
| WWSL2 | 74145 | \$90.99 | 12 volt AC | 2 | 45 Degrees | 1½"L x 1½"W x 1¾"H | --- | WW30X4 or 12 volt Transformer | 5-year Limited |
| CCSL2 | 74134 | \$121.99 | InfiColor | 2 | 45 Degrees | 1½"L x 1½"W x 1¾"H | SOL plug adapter | CCSM30X3 | 5-year Limited |



WWBL5 (Warm White)
CCBL5 (Color Changing)

- Linear lights are designed to wash walls, falls and spillways with a wide 120° beam angle
- Atlantic's solid brass Bar Light includes dual bases or stainless steel L-brackets to mount to any hard surface
- Mounted light rotates 30° in either direction for versatility in directing illumination
- Warm White matches 2800° Kelvin temperature of halogen and incandescent lighting
- Bar Lights feature 20' power cord and quick-connect plug for easy installation
- Flat 2-wire cord on Warm White can be cut, stripped and tied into existing systems
- InfiColor Smart Module and App (sold separately) unlock the full potential of Color Changing lights
- Color Changing Lights connect to SOL Lighting with included plug adapter

| MODEL | ITEM | LIST | INPUT | WATTS | BEAM ANGLE | DIMENSIONS | INCLUDES | REQUIRES | WARRANTY |
|-------|-------|----------|------------|-------|-------------|-------------------|--|-------------------------------|----------------|
| WWBL5 | 74136 | \$124.99 | 12 volt AC | 5 | 120 Degrees | 11½"L x ¾"W x ½"H | (2) Bases, L-brackets | WW30X4 or 12 volt Transformer | 5-year Limited |
| CCBL5 | 74126 | \$168.99 | InfiColor | 5 | 120 Degrees | 11½"L x ¾"W x ½"H | (2) Bases, L-brackets & SOL plug adapter | CCSM30X3 | 5-year Limited |

POND LIGHTING



SOLWPL1 (Warm White)
CCPL1 (Color Changing)



SOLWPL3 (Warm White)
CCPL3 (Color Changing)

- Submersible pond lights extend enjoyment of ponds and water features beyond dusk
- Atlantic's Single and Triple Pond Light Kits come complete with everything needed to illuminate waterscapes and the surrounding landscape
- Durable high-impact housing and replaceable diode assembly for long service life
- Triple Light Kit includes 12' cord from transformer to junction plus 8' to each light
- Warm White matches 2800° Kelvin color temperature of halogens and incandescents
- Warm White Pond Lights feature removable photocell light sensor with built-in memory
- Light sensor turns lights on at dusk, off after 6 hours, even if photocell gets covered
- Color Changing Pond Lights include single-zone InfiColor Smart Module to unlock the full potential of Color Changing Lights



Photocell



Module

| MODEL | ITEM | LIST | INPUT | WATTS | BEAM ANGLE | DIMENSIONS | INCLUDES | WARRANTY |
|---------|-------|----------|------------|-------|------------|----------------|---|----------|
| SOLWPL1 | 74101 | \$48.99 | 12 volt AC | 1 | 30 Degrees | 2½"L x 2"W | Light base, removable photocell & 12 volt outdoor transformer | 1-year |
| CCPL1 | 74094 | \$129.99 | InfiColor | 1 | 30 Degrees | 2½"L x 2"W | Light base, InfiColor Smart Module & 12 volt outdoor transformer | 1-year |
| SOLWPL3 | 74102 | \$102.99 | 12 volt AC | 3 | 30 Degrees | (3) 2½"L x 2"W | Light bases, removable photocell & 12 volt outdoor transformer | 1-year |
| CCPL3 | 74095 | \$186.99 | InfiColor | 3 | 30 Degrees | (3) 2½"L x 2"W | Light bases, InfiColor Smart Module & 12 volt outdoor transformer | 1-year |

LIGHTING WIRING



WWBSX4 (Warm White)
CCBSX4 (Color Changing)

- Atlantic quick-connect wiring makes connecting multiple fixtures fast and easy
- Compact inline 4-outlet Block Splitters for Warm White and Color Changing simplify connections and mount on flat surfaces to neaten and organize wiring
- All Splitters feature removable weatherproof caps for unused outlets and include dielectric grease
- Warm White Splitter can be stripped and spliced into existing low voltage systems
- Color Changing Splitters feature one-way keyed connections to eliminate misalignment and water intrusion

| MODEL | ITEM | LIST | DESCRIPTION | INPUT | DIMENSIONS | INCLUDES | WARRANTY |
|--------|-------|---------|-------------------------|------------|------------------------------|-------------------|----------|
| WWBSX4 | 74123 | \$19.99 | 4-outlet Block Splitter | 12 volt AC | 5"L x 1½"W x 1½"H w/ 4" cord | Weatherproof caps | 5-year |
| CCBSX4 | 74112 | \$28.99 | 4-outlet Block Splitter | InfiColor | 5"L x 1½"W x 1½"H w/ 4" cord | Weatherproof caps | 5-year |



WWEXT20 (Warm White)
CCEXT20 (Color Changing)

- Extension cords allow remote placement of lights where needed most in the landscape, waterscape and hardscape
- Atlantic's extensions feature silicone gaskets and dielectric grease for secure waterproof connections
- Warm White extension cord can be stripped and spliced into existing low voltage systems
- Color Changing Extension Cords feature one-way keyed connections to eliminate misalignment and water intrusion

| MODEL | ITEM | LIST | DESCRIPTION | INPUT | CORD | INCLUDES | WARRANTY |
|---------|-------|---------|----------------|------------|------|-------------------|----------|
| WWEXT20 | 74124 | \$19.99 | Extension Cord | 12 volt AC | 20' | Weatherproof caps | 5-year |
| CCEXT20 | 74113 | \$28.99 | Extension Cord | InfiColor | 20' | Weatherproof caps | 5-year |

DID YOU KNOW?

Both Single and Triple Pond Light Kits come with everything needed to set up automatic operation. Color Changing Kits feature a single-zone InfiColor Smart Module to control colors, transitions, sequences and timing. Warm White sets include photocells with light sensors that turn on at dusk and off after 6 hours of operation. Photocells are designed with a built-in memory that records the last 24 hours and repeats that schedule indefinitely if the photocell gets covered by debris or overgrown plantings.



DID YOU KNOW?

In response to contractor requests to modify lighting cord lengths, we have changed the light cords of our Warm White lighting fixtures, extensions and accessories from round multi-wire cord to flat two-wire low voltage wiring cord. Any flat two-wire cord can be shortened as desired, following best splicing practices. **NEVER CUT THE ROUND WIRES!!!** The multi-strand wire inside the round insulation is precisely matched to LED and driver output, and cannot be modified without damaging lights and voiding the warranty.





INFICOLOR SMART MODULE & APP

The InfiColor Smart Module and mobile application at the heart of the Color Changing Lighting System allow users to program custom color sequences and transitions, set sequence timing and daily scheduling and unlock all RGB options on any Apple or Android mobile device. The InfiColor Smart Module now controls three individual zones via Bluetooth® mobile application and is compatible with all Atlantic Color Changing Lighting and Color Changing Colorfalls, past and present, with simple adapters included with every Module.



- InfiColor Smart Module and App unlock the full potential of Color Changing Lights
- Smart Module is wirelessly controlled via InfiColor App, no remote necessary
- The three outlets of the InfiColor Smart Module can be synced and linked as a single zone or three zones may be controlled individually
- Each outlet can control up to 40 watts of Color Changing Lighting for a total of 120 watts per InfiColor Smart Module
- Upgrade any Atlantic Color Changing Lighting or Color Changing Colorfalls to the InfiColor System using the pigtail adapters included with every Module

INFICOLOR APP

The Bluetooth® InfiColor App makes custom colors, sequences, transitions, timing and daily scheduling of your Atlantic Color Changing Lighting or Color Changing Colorfalls accessible on any Apple or Android mobile device, no remote necessary.



- Select any or all of the three zones to control
- Choose any color visually or create a custom color with RGB sliders
- Combine and save custom color sequences as Favorites
- Assign one of five transitions and adjust the speed of any Favorite
- Adjust brightness of sequences and solid colors as desired
- The three zones can be independently named and scheduled
- InfiColor App available on all Apple or Android devices

DID YOU KNOW?

Actually, the InfiColor Smart Module and App don't really give you unlimited control of an infinite number of colors. We're sorry to say, we lied. The color choices of RGB systems are quite limited. The number of colors that can be generated by the combination of the 256 levels of Red, Green and Blue are only $256 \times 256 \times 256 = 16,777,216$. So in actuality, you only have unlimited control of 16.77 million colors with the new Atlantic Lighting System.

We apologize for misleading you.



WIRING KITS & TRANSFORMERS



- InfiColor Wiring Kit powers and connects up to three Color Changing Lights
- Color Changing Lights can be synced and linked as a single zone or three zones may be controlled individually
- Module includes removable weatherproof caps for unused outlets and dielectric grease
- 30 watt solid state Transformer is fully weatherproof for worry-free outdoor installations
- Add a larger Transformer and additional wiring components (not included) to power up to 120 watts of Color Changing Lighting, 40 watts per zone

| MODEL | ITEM | LIST | DESCRIPTION | INPUT | OUTPUT | INCLUDES | WARRANTY |
|----------|-------|----------|------------------------------|-------------|-----------|--|----------|
| CCSM30X3 | 74125 | \$149.99 | InfiColor 3 Light Wiring Kit | 120 volt AC | InfiColor | 30 Watt Transformer & (3) SOL Pigtail Adapters | 1-year |



- Warm White Wiring Kit powers and connects up to four Warm White Lights
- Compact inline 4-outlet Block Splitter simplifies connections and mounts on flat surfaces to neaten and organize wiring
- Splitter features removable weatherproof caps for unused outlets
- 30 watt solid state Transformer is fully weatherproof for worry-free outdoor installations
- Add additional Splitters (not included) to power up to 30 watts of Warm White Lighting

| MODEL | ITEM | LIST | DESCRIPTION | INPUT | OUTPUT | INCLUDES | WARRANTY |
|--------|-------|---------|-------------------------------|-------------|------------|---|----------|
| WW30X4 | 74122 | \$49.99 | Warm White 4 Light Wiring Kit | 120 volt AC | 12 volt AC | 30 Watt Transformer & 4-outlet Block Splitter | 1-year |



- Transformers provide dependable low voltage AC current to Atlantic LED Lighting Systems
- Solid state Transformers are fully weatherproof for worry-free outdoor installations
- TRANS88 and TRANS150 feature built-in photocell with light sensor and timer to turn on at dusk and off at dawn or after 4, 6 or 8 hours of operation
- Connect wiring directly to TRANS88 and TRANS150
- TRANS60 connects to 2-pin Warm White quick-connect plugs

| MODEL | ITEM | LIST | DESCRIPTION | INPUT | OUTPUT | WARRANTY |
|----------|-------|----------|----------------------|-------------|------------|----------|
| TRANS60 | 77031 | \$91.99 | 60 Watt Transformer | 120 volt AC | 12 volt AC | 1-year |
| TRANS88 | 74111 | \$104.99 | 88 Watt Transformer | 120 volt AC | 12 volt AC | 1-year |
| TRANS150 | 74110 | \$134.99 | 150 Watt Transformer | 120 volt AC | 12 volt AC | 1-year |

LUNAQUA CLASSIC LED



- LED Lighting extends your enjoyment of your landscape or waterscape into the evening
- OASE LunAqua Classic LED is all-in-one complete lighting kit with transformer and 3 lights
- Underwater LED spotlight casts a focused warm white light
- Adjustable head and 7' power cord for flexible positioning
- Suitable for use in and out of the water
- Energy-efficient multi-LED units consume only 1 watt per light
- May be wired into existing low voltage lighting systems
- Ideal for illuminating fountains, ponds and landscapes
- Includes 3 LED lights, 120 volt outdoor transformer and 3-way splitter

| ITEM | LIST | DESCRIPTION | INPUT | WATTS | BEAM ANGLE | CORD | DIMENSIONS | WARRANTY |
|-------|----------|---------------------|------------|-------|------------|------|------------|----------|
| 56453 | \$118.99 | LunAqua Classic LED | 12 volt AC | 3 | 20° | 7' | 3"W x 4½"H | 2-year |

LUNAQUA 3 LED



- LED Lighting extends your enjoyment of your landscape or waterscape into the evening
- OASE LunAqua 3 LED lights offer extraordinary luminous intensity with powerful 110 lumen output
- Adjustable head for flexible positioning on weighted base or ground spike
- 30° beam angle spotlight for pleasant warm white light accents in or out of the water
- Must be used with Underwater Transformer UST 150/01 (Model 50517) to power up to four devices
- Includes light with 25' power cord, weighted base and ground spike



Ground Spike

| ITEM | LIST | DESCRIPTION | INPUT | WATTS | BEAM ANGLE | DIMENSIONS | WARRANTY |
|-------|---------|---------------|------------|-------|------------|------------|----------|
| 56463 | \$75.99 | LunAqua 3 LED | 12 volt AC | 3 | 30° | 3"W x 5½"H | 2-year |

CONNECTION ACCESSORIES

- Waterproof Connection Cables extend distance of lights from Underwater Transformer
- Compatible with all LunAqua Lights except Classic series

| ITEM | LIST | DESCRIPTION | WARRANTY |
|-------|---------|----------------------|----------|
| 12768 | \$41.99 | 3' Connection Cable | 2-year |
| 12374 | \$46.99 | 10' Connection Cable | 2-year |
| 12375 | \$81.99 | 25' Connection Cable | 2-year |



- 12 volt Underwater Transformer is safe, waterproof and both seawater and chlorine resistant
- Connects up to 4 spotlights; use optional PowerBox Splitters to add additional lights

| ITEM | LIST | DESCRIPTION | INPUT | OUTPUT | DIMENSIONS | WARRANTY |
|-------|----------|------------------------|-------------|------------|------------------|----------|
| 50517 | \$237.99 | Underwater Transformer | 120 volt AC | 12 volt AC | 6"L x 5"W x 3½"H | 2-year |



- OASE PowerBox splits one cable into two outlets for distribution to up to 8 units in series from each of the four outlets on the Underwater Transformer

| ITEM | LIST | DESCRIPTION | DIMENSIONS | WARRANTY |
|-------|---------|-------------------|------------------|----------|
| 50492 | \$46.99 | PowerBox Splitter | 3"L x 3"W x 3¼"H | 2-year |



PROFILUX GARDEN LED RGB



- RGB LED Lighting is a colorful way to extend your enjoyment of your landscape or waterscape into the evening
- OASE ProfiLux Garden LED RGB produces the full spectrum of LED light in conjunction with the EGC Cloud Controller unit
- Adjustable head with innovative integrated clamping system for flexible positioning in a variety of applications including onto OASE 1" Nozzle Extension (page 19, not included)
- Energy efficient LED with stainless steel adjustment screws and reflector
- Suitable for use in and out of the water to a water depth of 13'
- 3 Light Set includes ProfiLux Garden LED Controller which is required to connect to EGC Cloud Controller (not included)
- ProfiLux Garden LED Controller connects up to 4 spotlights; multiple ProfiLux Controllers may be connected to the EGC System
- Requires EGC Cloud Controller unit for operation (page 5, not included)
- ProfiLux Garden LED RGB includes 1 spotlight with 16' power cable, base and ground stake
- ProfiLux Garden LED RGB Set 3 includes 3 spotlights with 16' power cord, 24 volt underwater ProfiLux Garden LED controller, 3 bases and 3 ground stakes

| ITEM | LIST | DESCRIPTION | INPUT | WATTS | BEAM ANGLE | DIMENSIONS | REQUIRES | WARRANTY |
|-------|----------|-------------------------------|------------|-------|------------|------------|--|----------|
| 72376 | \$739.99 | ProfiLux Garden LED RGB Set 3 | 24 volt DC | 19 | 25° | 3"W x 4½"H | EGC Cloud Controller | 3-year |
| 72377 | \$170.99 | ProfiLux Garden LED RGB | 24 volt DC | 6 | 25° | 3"W x 4½"H | ProfiLux Garden LED Controller, EGC Cloud Controller and 24 volt transformer | 3-year |

EASY GARDEN CONTROL (EGC)

Connect your ProfiLux Lights to the Easy Garden Control (EGC) to fully control each light, up to 40 lights, from anywhere in the world on any Android or Apple device with EGC mobile application. See page 5 for more information on the EGC Controller Cloud.

The EGC can display and control a variety of functions including:

- 9 preset color choices
- Color wheel for infinite color choices
- Brightness control
- Access 11 pre-programmed light shows
- Light show speed control
- All lights can be individually controlled



PROFILUX ACCESSORIES

PROFILUX GARDEN LED CABLE

- Extends the distance between ProfiLux Garden LED RGB Spotlights and LED Controller 24 feet
- Suitable for use in and out of the water



| ITEM | LIST | DESCRIPTION | WARRANTY |
|-------|---------|-------------------------------|----------|
| 72379 | \$78.99 | 24' ProfiLux Garden LED Cable | 2-year |

PROFILUX GARDEN LED CONTROLLER

- Underwater controller is required for operation of ProfiLux Garden LED lights
- Connect to EGC Cloud Controller (sold separately) for wireless control of Spotlights
- Powers up to 4 ProfiLux Spotlights with 30 watts of 24V current



| ITEM | LIST | DESCRIPTION | CORD | DIMENSIONS | WARRANTY |
|-------|----------|--------------------------------|------|--------------------|----------|
| 72378 | \$283.99 | ProfiLux Garden LED Controller | 16' | 8½"L x 4½"W x 2¾"H | 3-year |



DID YOU KNOW?



ProfiLux Lights include a mounting attachment for Fountain Heads or any other shaft, column or object up to 1" in diameter. This allows for unique lighting opportunities in the landscape and underwater.

MAINTENANCE

Atlantic offers a full line of maintenance products that will keep your water feature healthy and beautiful for years to come. Triton Ionizer and treatments keep your pond crystal clear. Pond & Garden Protectors prevent accumulation of leaves and debris when the weather is less favorable. Winter or summer, Typhoon Air Pumps keep water moving and fish healthy. OASE PondoVacs keep ponds and fountains sparkling clean without draining.

- » The Triton Ionizer integrates seamlessly to the Triton Check Valve or directly to PVC or Kink-Free pipe for the easiest installation possible and the app provides control right from your smart device
- » PondoVac pond vacuums remove settled debris and wastes from the bottom and sides of ponds and fountains
- » Water treatments offer a wide variety for solutions for all of your aquatic needs
- » Aeration products keep ponds aerated and breathing well year-round in the most economical manner possible
- » Pond & Garden Protectors, Pond Nets and tools make caring for ponds, water features and gardens faster and easier



TRITON IONIZER



- Ionizers mineralize the water to keep water features clean and clear with minimal oversight
- Atlantic's TRION3 Ionizer integrates seamlessly with the TR215CV Check Valve
- Easily installed in any new or existing water feature, clears water without the use of harsh chemicals
- Level of mineralization is controlled by the LED panel
- Treats ponds up to 25,000 gallons, safe for fish and plants when used correctly
- Electrodes are easily replaced without tools
- Includes 1" to 1½" tapered insert fittings for connection to metric and ASTM standard tubing

| MODEL | ITEM | LIST | DESCRIPTION | INPUT | WATTS | INLET/OUTLET | INCLUDES | WARRANTY |
|--------|-------|----------|--------------------------|------------|-------|---------------|--|----------|
| TRION3 | 74055 | \$314.99 | Electric Water Clarifier | 12 volt AC | 2 | 2" Sch 40 PVC | Transformer, test strips and insert fittings | 3-year |

TRITON IONIZER APP



Download our new Triton Ionizer app on the App Store and Google Play to wirelessly control the TRION3 ionizer from your smartphone or tablet.



- The Ionizer app allows you to adjust the level of ionization and turn the power on/off
- Conductivity alert will inform you if your water is not conductive enough for selected ionization level
- Customize network name and password for secure access
- Effortlessly switch between multiple Ionizers in Wi-Fi settings to control different water features
- Available for both Android™ and Apple® smartphones and tablets

IONIZER ACCESSORIES



TRION2-RA

- Replacement anode for TRION2 and TRION3 Ionizers



TRION-TS

- 50 Alkalinity/pH/Copper test strips in foil packets for long shelf life

| MODEL | ITEM | LIST | DESCRIPTION | SHELF LIFE |
|-----------|-------|---------|--|---------------------------|
| TRION2-RA | 74054 | \$73.99 | Replacement Anode for TRION2 and TRION3 Ionizers | --- |
| TRION-TS | 74057 | \$13.99 | Alkalinity/pH/Copper Test Strips | 2-years from Born on Date |



WATER TREATMENTS

BIOMAX – WEEKLY BIOLOGICAL CONDITIONER

- Beneficial bacteria metabolize organic waste and neutralize odors
- Atlantic's BioMax contains billions of potent microbial strains plus enzymes
- Improved ecological balance lowers nitrates that promote unwanted plant growth
- Use weekly to reduce organics and keep pond water clear and healthy



| MODEL | ITEM | LIST | SIZE | TREATS |
|-------|-------|----------|--------|----------------|
| WTBM1 | 74058 | \$28.99 | 1 lb. | 16,000 gallons |
| WTBM2 | 74059 | \$45.99 | 2 lbs. | 32,000 gallons |
| WTBM6 | 74060 | \$115.99 | 6 lbs. | 96,000 gallons |

BIOMAX+ – ENHANCED BIOLOGICAL CONDITIONER

- Liquid bacterial formula naturally removes organic debris, ammonia and nitrates
- Atlantic's BioMax+ balances pond ecosystem, enhances bacterial activity and seeds biological filters
- Specialized bacterial mix speeds up the natural cycle that maintains a healthy balanced ecosystem
- Use weekly to remove toxins and promote excellent water quality



| MODEL | ITEM | LIST | SIZE | TREATS |
|--------|-------|---------|--------|----------------|
| WTBM16 | 74061 | \$12.99 | 16 oz. | 6,000 gallons |
| WTBM32 | 74063 | \$16.99 | 32 oz. | 12,000 gallons |
| WTBM1G | 74062 | \$49.99 | 1 gal. | 48,000 gallons |

DID YOU KNOW?

Atlantic Bacterial Water Treatments contain benign naturally occurring bacteria present in ponds, lakes and streams. The only difference between natural colonies of bacteria and the safe, non-toxic formulas in our bacterial products are the concentrations. Atlantic's bacteria are measured in Colony Forming Units (CFU) with the least potent concentration equal to 1 billion CFU's per gram. That means in every pound of our highly concentrated formulas there are at least **450 billion** bacteria ready to safely clean and clear the water in your water feature!



CLARITYBLAST – COMBINATION POND CLEANER

- Pond Cleaner cleans waterfalls, streams, ponds, plant pots and filters
- Atlantic's ClarityBlast is an all-natural proprietary treatment with bacteria and enzymes
- Keeps pond water and hard surfaces clean by removing attached organics
- Use as directed to remove algae stains and attached organics



| MODEL | ITEM | LIST | SIZE | TREATS |
|-------|-------|----------|--------|----------------|
| WTCB1 | 74064 | \$23.99 | 1 lb. | 8,000 gallons |
| WTCB2 | 74065 | \$45.99 | 2 lbs. | 16,000 gallons |
| WTCB6 | 74066 | \$116.99 | 6 lbs. | 48,000 gallons |

RECLAIM – NATURAL SLUDGE REMOVER

- Sludge removers eliminate the build-up of dead algae, decomposing leaves and fish waste
- Atlantic's ReClaim tablets quickly go to work removing sludge on the bottom of ponds and streams
- Regular use reduces the frequency of pond cleanouts and overall pond maintenance
- Apply tablets bi-weekly for best results



| MODEL | ITEM | LIST | SIZE | TREATS |
|--------|-------|---------|--------------------|-------------------|
| WTRC24 | 74069 | \$23.99 | 24 - ½ oz. Tablets | 1,200 square feet |
| WTRC48 | 74070 | \$38.99 | 48 - ½ oz. Tablets | 2,400 square feet |
| WTRC72 | 74071 | \$56.99 | 72 - ½ oz. Tablets | 3,600 square feet |

ECOSOLV – LIQUID POND CLEANER

- Water clarifiers clear discolored water in ponds, streams, waterfalls and bubblers
- Atlantic's EcoSolv extra strength formula is the fastest water clarifier on the market
- Requires heavy aeration to maintain oxygen levels and keep fish safe, especially in hot weather
- Use as needed to clear discolored pond water in as little as 48 hours



| MODEL | ITEM | LIST | SIZE | TREATS |
|--------|-------|---------|--------|----------------|
| WTES16 | 74085 | \$14.99 | 16 oz. | 9,600 gallons |
| WTES32 | 74087 | \$23.99 | 32 oz. | 19,200 gallons |
| WTES1G | 74086 | \$75.99 | 1 gal. | 76,800 gallons |

ECOKLEAN – OXY POND CLEANER

- Oxy pond cleaners quickly remove attached organics and algae stains from rocks, waterfalls and streambeds
- Atlantic's EcoKlean fast dissolving granules lift debris to the surface with the power of pure oxygen
- Regularly use may eliminate the need for disruptive, expensive pond clean-outs
- Use as needed to keep hard surfaces clean and free of attached organics



| MODEL | ITEM | LIST | SIZE | TREATS |
|--------|-------|---------|---------|-------------------|
| WTEK1 | 74082 | \$14.99 | 1 lb. | 400 square feet |
| WTEK2 | 74084 | \$22.99 | 2 lbs. | 800 square feet |
| WTEK10 | 74083 | \$58.99 | 10 lbs. | 4,000 square feet |



WATER TREATMENTS

REVIVE – DECHLORINATOR WITH STRESS REDUCER



- Dechlorinators remove fish-toxic chlorine, chloramines, ammonia and heavy metals in tap water
- Atlantic's ReVive with stress reducer thickens the slime coat of Goldfish and Koi in times of stress
- Enhancing protective slime coat of fish helps fish recover from cuts and abrasions
- Use every time water is added or when moving fish



| MODEL | ITEM | LIST | SIZE | TREATS |
|--------|-------|---------|--------|---------------|
| WTRV16 | 74074 | \$15.99 | 16 oz. | 3,200 gallons |
| WTRV32 | 74075 | \$23.99 | 32 oz. | 6,400 gallons |

QUICKCLEAR – WATER CLARIFIER



- Water clarifier flocculates water, causing particles to clump together and drop to the bottom
- Atlantic's QuickClear restores brilliant clarity to water clouded by sediment or organics
- Once out of suspension, debris can be easily filtered or vacuumed out
- Use to clear water after heavy rains or prolonged heat spells



| MODEL | ITEM | LIST | SIZE | TREATS |
|--------|-------|---------|--------|----------------|
| WTQC16 | 74067 | \$13.99 | 16 oz. | 8,000 gallons |
| WTQC32 | 74068 | \$21.99 | 32 oz. | 16,000 gallons |

REFRESH – COLORFALLS & FOUNTAIN TREATMENT



- Fountain treatments keep fountains clean and free from stains, sludge and odors
- Atlantic's ReFresh metabolizes organic debris keeping Colorfalls and Fountain Basins clear and free from odor
- Safe for use in birdbaths and basins where pets and wildlife may drink
- Use to freshen water in Fountain, Formal Spillway and Pond-free applications



| MODEL | ITEM | LIST | SIZE | TREATS |
|--------|-------|---------|--------|---------------|
| WTRF16 | 74072 | \$14.99 | 16 oz. | 1,600 gallons |
| WTRF32 | 74073 | \$23.99 | 32 oz. | 3,200 gallons |

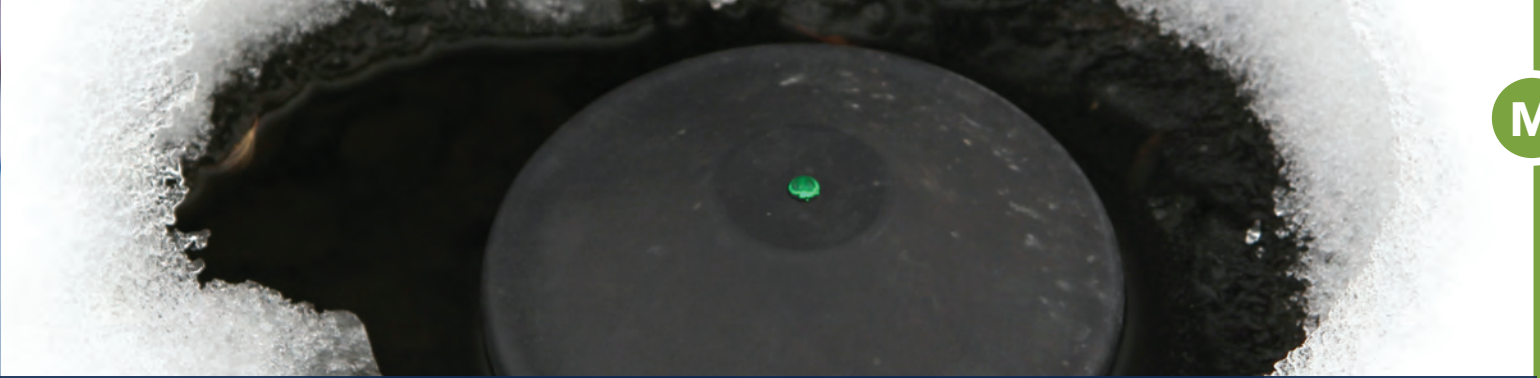

POND DE-ICER



- Pond de-icers maintain a small area free of ice, allowing oxygen in and toxic gases like carbon dioxide and methane out of pond water in winter
- Atlantic's Pond De-Icer saves energy by cycling on and off, maintaining an internal temperature of 200° under the worst conditions
- Constructed of high strength and high temperature PPS polymer for maximum durability
- Internal thermostat turns heater on just above freezing and off as water warms for fully automatic operation
- Indicator light shines blue to show the De-Icer is in standby mode when plugged in with water temperature above freezing
- Indicator light shines green to show water temperature is below freezing and De-Icer is in operation
- Efficient heating element only draws 300 watts when needed to keep a small area free of ice and operating costs low*

| MODEL | ITEM | LIST | VOLTS | WATTS | CORD | DIMENSIONS | WARRANTY |
|-------|-------|----------|-------|-------|------|------------|----------|
| PD300 | 73986 | \$112.99 | 120 | 300* | 20' | 8"W x 4"H | 1-year |

TECH TIP



Unlike typical de-icers that only indicate the heating cycle, Atlantic's De-Icer shines blue to show the unit is plugged in and operational even when the water temperatures are above freezing. As the temperature drops the light changes to green, cycling on and off to indicate active heating. This not only saves money by only using electricity when heating, it also verifies the unit is ready for operation before icing even occurs.



TYPHOON AIR PUMPS

Atlantic's Typhoon Air Pumps feature weatherproof, continuous duty diaphragm compressors specifically designed for year-round usage. Ideal for aeration and circulation in warm weather, these aerators are also excellent for de-icing and gas exchange in freezing weather. With diffuser options for ponds from 1,000 to 12,000 gallons, Typhoon Air Pumps adapt to most backyard ponds. Best of all Typhoon Air Pumps are easily rebuildable and exceptionally efficient!

DIAPHRAGM AIR PUMPS



TA1800

- Maintain maximum O₂ levels in summer, gas diffusion in winter
- Easy to clean air filter reduces particulates for motor longevity
- Most cost efficient way to keep an area free of ice in winter
- Aluminum housing radiates and reduces heat to extend diaphragm life



TA3600

- Replaceable diaphragms for extended service life
- Includes 3/8" insert fitting for most vinyl air tubing or use stainless steel band clamp (not included) with 1/2" tubing over outlet

| MODEL | ITEM | LIST | OUTLET | VOLTS | WATTS | MAX PRESSURE | MAX DEPTH | CORD LENGTH | DIMENSIONS | WARRANTY |
|--------|-------|----------|------------------------|-------|-------|--------------|-----------|-------------|-------------------------|----------------|
| TA1800 | 73941 | \$173.99 | 3/8" insert, 1/2" slip | 115 | 25 | 3 psi | 7' | 6' | 6 3/4"L x 5"W x 5 1/4"H | 3-year Limited |
| TA3600 | 73942 | \$270.99 | 3/8" insert, 3/8" slip | 115 | 35 | 5 psi | 11' | 6' | 7 1/4"L x 7"W x 6 1/2"H | 3-year Limited |

AIR PUMP OUTPUT

| MODEL | | MAX | @ 1' | @ 2' | @ 3' | @ 4' | @ 5' | @ 6' | @ 8' | @ 10' |
|--------|-----------|------------|-----------|-------------|-----------|------------|-----------|-----------|-----------|----------|
| TA400 | LPM / CFM | 6.5 / 0.23 | 6 / 0.21 | 5.1 / 0.18 | 4 / 0.14 | 2.5 / 0.09 | 1 / 0.04 | --- | --- | --- |
| TA800 | LPM / CFM | 13 / 0.46 | 12 / 0.42 | 10.2 / 0.36 | 8 / 0.28 | 5 / 0.18 | 2 / 0.07 | --- | --- | --- |
| TA1800 | LPM / CFM | 30 / 1.06 | 25 / 0.88 | 21 / 0.74 | 17 / 0.60 | 13 / 0.46 | 9 / 0.32 | 4 / 0.14 | --- | --- |
| TA3600 | LPM / CFM | 60 / 2.12 | 54 / 1.91 | 47 / 1.66 | 40 / 1.41 | 34 / 1.2 | 28 / 0.99 | 23 / 0.81 | 12 / 0.42 | 2 / 0.07 |

MINI AERATION KITS



TAKIT0400

- Dependable aeration for smaller ponds 5' deep or less
- Replaceable diaphragm cartridges extend pump service life



TAKIT0800

- Weighted air stones with rim guards stand up to multi-season use
- Kits include air pump with 6' cord, 4" air stones, in-line check valves and tubing as shown

| MODEL | ITEM | LIST | PUMP | TUBING SIZE | WATTS | MAX DEPTH | POND VOLUME | DIMENSIONS | WARRANTY |
|-----------|-------|----------|-------|----------------|-------|-----------|---------------|-----------------------------|----------------|
| TAKIT0400 | 73943 | \$72.99 | TA400 | 1/4" x 20' | 4.5 | 5' | 1,000 gallons | 6 1/2"L x 4"W x 3 3/4"H | 3-year Limited |
| TAKIT0800 | 73944 | \$111.99 | TA800 | (2) 1/4" x 20' | 9 | 5' | 2,000 gallons | 6 1/2"L x 6 1/4"W x 3 3/4"H | 3-year Limited |

PROFESSIONAL AERATION KITS



TADKIT1800

- High output for larger water gardens and koi ponds with greater oxygen demand
- High efficiency non-clogging diffuser tubing is less restrictive than stones or rubber diaphragms for greater flows and longer pump life
- Circular diffuser design maximizes upwelling and water circulation and gas exchange



TADKIT3600

- Diffusers come unweighted to reduce shipping costs and will require filling with your choice of sand or gravel
- Kits include air pump with 6' cord, 8" diffusers, fittings, 2-way splitter (TADKIT3600 only), in-line check valves and 3/8" weighted tubing as shown

| MODEL | ITEM | LIST | PUMP | TUBING SIZE | WATTS | MAX DEPTH | POND VOLUME | DIMENSIONS | WARRANTY |
|------------|-------|----------|--------|---------------------|-------|-----------|----------------|-------------------------|----------------|
| TADKIT1800 | 73939 | \$292.99 | TA1800 | 3/8" x 20' weighted | 25 | 7' | 6,000 gallons | 6 3/4"L x 5"W x 5 1/4"H | 3-year Limited |
| TADKIT3600 | 73940 | \$514.99 | TA3600 | 3/8" x 40' weighted | 35 | 11' | 12,000 gallons | 7 1/4"L x 7"W x 6 1/2"H | 3-year Limited |



AQUAOXY AERATION

AQUAOXY SET



44110

- Aeration systems maintain high oxygen levels in summer and aid in gas diffusion in winter
- OASE AquaOxy Sets come complete with tubing and diffusers for an all-in-one aeration solution for smaller ponds and water gardens
- Quiet, energy efficient air pumps feature replaceable diaphragms for long service life



44116

- Sleek, compact design is weatherproof for outdoor use
- Carborundum air stones deliver high volume with uniform bubble distribution
- Includes two air stones, 16' air hose, two replacement diaphragms, and Y-distributor (240 only)



44117

| ITEM | LIST | DESCRIPTION | VOLTS | WATTS | MAX DEPTH | MAX LPM | CORD LENGTH | DIMENSIONS | TUBING SIZE | WARRANTY |
|-------|----------|-----------------|-------|-------|-----------|---------|-------------|-------------------|--------------|----------|
| 44110 | \$46.99 | AquaOxy Set 55 | 120 | 4 | 4' | 4.4 | 5' | 6"L x 3½"W x 3½"H | (2) ⅜" x 16' | 2-year |
| 44116 | \$70.99 | AquaOxy Set 120 | 120 | 6 | 4' | 7.6 | 5' | 7½"L x 4½"W x 4"H | (2) ⅜" x 16' | 2-year |
| 44117 | \$105.99 | AquaOxy Set 240 | 120 | 12 | 4' | 15.1 | 5' | 9½"L x 6¾"W x 5"H | (2) ⅜" x 16' | 2-year |

AQUAOXY 450



- Aeration systems maintain high oxygen levels in summer and aid in gas diffusion in winter
- OASE AquaOxy 450 is a safe 12V air compressor with dual valved outlets for versatile, energy efficient air delivery to dual locations in pond
- All-in-one aeration system includes silicone tubing and 2 weighted, high volume air stones
- Stainless steel regulating valves allow for easy air adjustment to air stones
- Durable, weatherproof UV stabilized housing dampens noise for quiet operation
- AquaOxy 450 is designed to supplement aeration in OASE filters
- Includes two air stones, 16' silicone air hose, 120V outdoor transformer

| ITEM | LIST | VOLTS | WATTS | MAX PRESSURE | MAX DEPTH | CORD LENGTH | DIMENSIONS | TUBING SIZE | WARRANTY |
|-------|----------|-------|-------|--------------|-----------|-------------|-----------------|--------------|----------|
| 50041 | \$189.99 | 120 | 25 | 3.6 psi | 7' | 15' | 9"L x 9"W x 5"H | (2) ⅜" x 16' | 2-year |



OXYTEX



- Aeration systems maintain high oxygen levels in summer and aid in gas diffusion in winter
- OASE OxyTex combines a high efficiency pond diffuser with high surface area filter medium
- Provides a unique combination of gas diffusion, water circulation and nutrient decomposition
- The ideal habitat for beneficial bacteria, the OxyTex improves filtration efficiency and contributes to a healthy pond environment
- Supplements ammonia and nitrite removal capability of the pond bacteria
- Designed for use with the OASE AquaOxy 450
- Patented grass-like fiber structure blends perfectly into any pond
- Replaceable air stone for long service life
- Includes 16' of ⅜" air hose, air hose adapter for larger diffuser tubing and diffuser plate

| ITEM | LIST | MAX PRESSURE | MAX DEPTH | MAX LPM | DIMENSIONS | TUBING SIZE | WARRANTY |
|-------|----------|--------------|-----------|---------|------------|-------------|----------|
| 51075 | \$118.99 | 5.8 psi | 14' | 16.6 | 9"W x 12"H | ⅜" x 16' | 2-year |

DID YOU KNOW?



The bacteria that decompose fish waste, primarily ammonia and nitrites, require copious amounts of oxygen to perform efficiently. The OxyTex optimizes bacterial decomposition by maximizing the amount of oxygen available to the aerobic bacteria that the pond depends on for good water quality. The grasslike filaments also provide 38 square feet of biological filter surface to vastly increase beneficial bacterial activity.

ICEFREE 4 SEASONS



- Circulators help keep an area of the pond free of ice in winter
- OASE IceFree 4 Seasons can be used year-round. In colder months it will keep a small hole open in the ice or in warmer months use as a decorative fountain
- In colder seasons, it circulates warm water from the bottom to melt a small hole around the float body, no heating element necessary
- Useful in every season, in summer IceFree 4 Seasons is an efficient and inexpensive aerator
- Gentle circulation ensures gas diffusion of oxygen into the pond and harmful gasses out
- Optimal gas diffusion maintains a safe environment for aquatic plants and animals
- Requires a depth of at least 30" for unit to function in low temperatures
- Float body is designed to evenly disperse the water onto the pond's surface
- Extremely energy-efficient pump requires only 6 watts
- Includes pump with filter housing, float body, 2 nozzle heads, filter bag, nozzle extension, stop plug, hose and connector



| ITEM | LIST | VOLTS | WATTS | MAX FLOW RATE | CORD LENGTH | DIMENSIONS | WARRANTY |
|-------|---------|-------|-------|---------------|-------------|-------------------|----------------|
| 72931 | \$67.99 | 120 | 6 | 110 | 25' | 8"L x 6½"W x 33"H | 2-year Limited |

TOOLS & ACCESSORIES

EASYPICK

- OASE EasyPick premium pond pliers facilitate the removal of large debris, cuttings or leaves in and around the pond
- Adjustable 78" telescoping handle reaches into the most inaccessible corners and depths, no need to get wet
- Rubberized triple gripper for firm and secure holds of even slippery debris



| ITEM | LIST | DESCRIPTION | DIMENSIONS | WARRANTY |
|-------|---------|-------------|-------------|----------|
| 42764 | \$57.99 | EasyPick | 54"L x 3½"W | 2-year |

FLEXICUT 2-IN-1

- 2 in 1 pond scissors that simultaneously cut and hold pruned aquatic material
- Adjustable head accommodates multiple working angles to protect the pond liner from cuts
- Also suitable for cutting terrestrial plants and thin branches



| ITEM | LIST | DESCRIPTION | DIMENSIONS | WARRANTY |
|-------|---------|-----------------|--------------|----------|
| 46970 | \$46.99 | FlexiCut 2-in-1 | 65½"L x 2½"W | 2-year |

POND NET

- Perfect for skimming, strong enough to remove wet leaves and muck
- Coated frame protects pond liner and fish
- Lightweight & durable 1" diameter handle telescopes from 46" to 63" for maximum versatility



| ITEM | LIST | DESCRIPTION | DIMENSIONS | WARRANTY |
|-------|---------|-------------|-------------|----------|
| 46934 | \$29.99 | PondNet | 46"L x 15"W | 2-year |

AQUATIC PLANT BASKET

- Durable plastic mesh allows aquatic plant roots to more efficiently remove excess nutrients from the water column
- Strong construction keeps plants under control over multiple growing seasons
- Makes pruning, fertilizing and maintenance more convenient



| ITEM | LIST | DESCRIPTION | DIMENSIONS | WARRANTY |
|-------|--------|----------------------|-------------------|----------|
| 45386 | \$5.99 | Aquatic Plant Basket | 10"L x 10"W x 6"H | 1-year |



NETTING



- Netting keeps out leaves and other wind blown debris for a clean pond in the fall and spring
- Durable poly netting is UV-resistant for extended lifespan
- Physical barrier also protects fish from heron and other predators
- Netting your pond reduces organic wastes that can fuel algae growth and reduce oxygen levels
- 1/2" x 1/2" openings keep out smaller windblown debris
- 4 pre-cut and 3 roll sizes fit most water feature designs
- New stake design is longer with a larger diameter head for improved net retention
- Stakes available in 50 piece quantities for use with 100' rolled netting



| MODEL | ITEM | LIST | SIZE | HOLE SIZE | INCLUDES | WARRANTY |
|---------|-------|----------|---------------|-------------|----------------------------|----------|
| PN1015 | 74047 | \$23.99 | 10' x 15' | 1/2" x 1/2" | 12 UV-Resistant Net Stakes | 1-year |
| PN1520 | 74048 | \$36.99 | 15' x 20' | 1/2" x 1/2" | 12 UV-Resistant Net Stakes | 1-year |
| PN2020 | 74050 | \$45.99 | 20' x 20' | 1/2" x 1/2" | 12 UV-Resistant Net Stakes | 1-year |
| PN2030 | 74051 | \$63.99 | 20' x 30' | 1/2" x 1/2" | 12 UV-Resistant Net Stakes | 1-year |
| PN10100 | 74046 | \$92.99 | 10' x 100' | 1/2" x 1/2" | --- | 1-year |
| PN20100 | 74049 | \$186.99 | 20' x 100' | 1/2" x 1/2" | --- | 1-year |
| PN30100 | 74052 | \$279.99 | 30' x 100' | 1/2" x 1/2" | --- | 1-year |
| PNS50 | 74053 | \$21.99 | 6"L x 1 1/2"W | --- | 50 Net Stakes | 1-year |

TECH TIP

To prevent leaves from decomposing and fouling the water, stretch your nets as tightly as possible over the water feature just before the leaves begin to fall. This will keep the leaves from accumulating below water level. For best results use the Pond and Garden Protector which keeps leaves out of your pond completely.



POND & GARDEN PROTECTOR

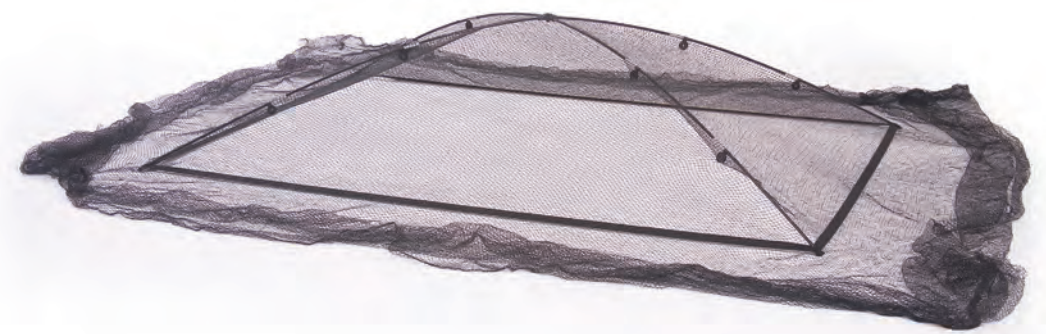

- The Pond and Garden Protector elevates the netting to keep leaves and other wind blown debris out of your pond or garden
- Domed design allows pond and garden plants to grow unobstructed under netting
- UV-resistant poly netting extends usable life
- 1/2" x 1/2" openings protects fish from heron and other predators
- Helps prevent algae growth in your pond by reducing organic waste that can enter your pond
- Keeps out rabbits, deer and other herbivores to protect your garden during the growing season

| MODEL | ITEM | LIST | NET SIZE | ASSEMBLED SIZE | INCLUDES | WARRANTY |
|-------|-------|----------|-----------|----------------------|---|----------|
| PGPSM | 74045 | \$95.99 | 15' x 20' | 7'W x 9'L x 2'H | Nylon Base, Center Receptor, (4) Fiberglass Poles, (4) 12' Tie-downs, (4) Ground Stakes, (12) Net Stakes, (8) Net Clips | 1-year |
| PGPLG | 74044 | \$109.99 | 20' x 20' | 9'W x 12'L x 2 1/2'H | Nylon Base, Center Receptor, (4) Fiberglass Poles, (4) 12' Tie-downs, (4) Ground Stakes, (12) Net Stakes, (8) Net Clips | 1-year |



POND FEATURES:

- Keeps out leaves and other windblown debris
- Protects fish from heron and other predators
- Helps prevent algae growth by reducing organic waste



GARDEN FEATURES:

- Protects fruiting plants and vegetables
- Allows for sunlight and optimum plant ventilation
- Can be covered with plastic to protect against frost

DID YOU KNOW?

The Pond and Garden Protector makes an ideal instant line of defense against many types of predators including osprey, hawks, herons, egrets, kingfishers and raccoons. Once assembled the Pond and Garden Protector can easily be moved by one person, handy for immediate deployment or easy access to your water feature. Visit our YouTube channel for a step-by-step video on how to assemble the Pond & Garden Protector, www.YouTube.com/awgtv1.





PONDovacs

- Pond vacuums remove debris from ponds, fountains, waterfalls, spas and pools without needing to drain the feature
- All PondoVacs include a wastewater discharge, a debris collection bag and a transparent suction tube to visually monitor debris intake
- OASE PondoVacs feature powerful suction, portability and a variety of attachments to handle any maintenance task

PONDovac CLASSIC



- OASE PondoVac Classic is perfect for cleaning small to medium sized water features, ponds and spas
- PondoVac Classic has a suction capacity of up to 800 gph
- Automatically empties tank when full through wastewater discharge hose
- Illuminated rocker switch signals power is on
- Compact design and built-in handle allow for easy movement and transportation
- Includes 3 suction tubes, 1 transparent suction tube, 4 suction nozzles, debris collection bag, 13' suction hose and 7' discharge hose

| ITEM | LIST | WATTS | MAX FLOW | MAX SUCTION DEPTH | CORD LENGTH | DIMENSIONS | TANK VOLUME | WARRANTY |
|-------|----------|-------|----------|-------------------|-------------|--------------------|-------------|----------|
| 57347 | \$295.99 | 1400 | 800 gph | 6' | 13' | 15"L x 15"W x 24"H | 7 gal | 2-year |

PONDovac 3



- OASE PondoVac 3 features continuous suction and waste discharge
- Two chamber system fills and empties alternating chambers for continuous suction and gravity discharge
- PondoVac 3 has a suction capacity of up to 1050 gph
- Wheeled chassis with suction tube sockets to conveniently carry attachments
- Adjustable handle for fast and convenient transportation
- Includes 3 robust aluminum tubes, 1 transparent suction tube, 4 suction nozzles, debris collection bag, 16' suction hose and 8' discharge hose

| ITEM | LIST | WATTS | MAX FLOW | MAX SUCTION DEPTH | CORD LENGTH | DIMENSIONS | TANK VOLUME | WARRANTY |
|-------|----------|-------|----------|-------------------|-------------|--------------------|-------------|----------|
| 37230 | \$431.99 | 1600 | 1050 gph | 7' | 14' | 15"L x 16"W x 26"H | 5½ gal | 2-year |

PONDovac 4



- OASE PondoVac 4 features continuous suction and waste discharge
- Two chamber system fills and empties alternating chambers for continuous suction and gravity discharge
- PondoVac 4 has a suction capacity of up to 1300 gph
- Wheeled chassis with suction tube sockets to conveniently carry attachments
- Adjustable handle for fast and convenient transportation
- Includes 3 robust aluminum tubes, 1 transparent suction tube, 5 suction nozzles, debris collection bag, 16' suction hose and 8' discharge hose

| ITEM | LIST | WATTS | MAX FLOW | MAX SUCTION DEPTH | CORD LENGTH | DIMENSIONS | TANK VOLUME | WARRANTY |
|-------|----------|-------|----------|-------------------|-------------|--------------------|-------------|----------|
| 50409 | \$498.99 | 1800 | 1300 gph | 8' | 14' | 15"L x 16"W x 26"H | 5½ gal | 2-year |

PONDovac 5



- OASE PondoVac 5 features uninterrupted vacuuming with continuous waste discharge
- Two pump system simultaneously vacuums while integrated waste pump continuously empties tank
- PondoVac 5 has a suction capacity of up to 2100 gph
- Wheeled chassis with 6" commercial wheels ensure stable movement through rough terrain
- Adjustable handle and suction tube sockets for fast and convenient transportation of attachments
- Includes 4 robust aluminum tubes, 1 transparent suction tube, 5 suction nozzles, debris collection bag, internal coarse debris collection bag, 16' suction hose and 33' discharge hose

| ITEM | LIST | WATTS | MAX FLOW | MAX SUCTION DEPTH | CORD LENGTH | DIMENSIONS | TANK VOLUME | WARRANTY |
|-------|----------|-------|----------|-------------------|-------------|-----------------------|-------------|----------|
| 48080 | \$822.99 | 1800 | 2100 gph | 7' | 25' | 17¼"L x 16¼"W x 28¼"H | 8½ gal | 3-year |

PONDovac NOZZLES

| | ADJUSTABLE FLOOR | STRING ALGAE | WIDE | CREVICE | WET SUCTION | AREA | BRUSH |
|------------------|------------------|--------------|------|---------|-------------|------|-------|
| PONDovac CLASSIC | • | • | • | • | | | |
| PONDovac 3 | • | • | | • | • | | |
| PONDovac 4 | • | • | | | • | • | • |
| PONDovac 5 | • | • | | | • | • | • |

Atlantic's Aeration System offers everything you need for the health and maintenance of large ponds and lakes. The sophisticated suite of products includes powerful Air Compressors, sub-surface Diffusers and decorative floating Aerators optimized for every size and depth body of water. We took our time to develop the best system on the market today — efficient and economical, engineered for excellence!

- » Air Diffusers are economical to ship, easy to deploy and maintain and more efficient at circulation and gas diffusion
- » Robust Compressors are reliable, rebuildable and economical to run and service
- » Long lasting Direct Burial and Weighted Tubing simplifies sub-surface installation
- » Treatments provide solutions for almost every pond and lake problem
- » Fully equipped Cabinets protect and soundproof equipment securely
- » All Systems come complete with every component needed for your project
- » Floating Fountain Aerators that excel in shallow water offer visual displays by day and night



WHY AERATION?

Oxygen is essential to the biology of a healthy pond or lake, but it's often in short supply. When there isn't enough oxygen, fish and other aquatic animals can suffocate, wastes generate noxious gases and water may foul.

Subsurface aeration brings oxygen levels up, dissipates toxic gases and evens out temperature and saturation levels throughout the water feature. Aeration is also the most efficient way to circulate water, moving 10 times as much per watt as water pumps.

Finally, aeration greatly accelerates the decomposition of solid and dissolved wastes. Although smaller water features may respond to other strategies, aeration is the only way to effectively manage nutrient removal, algae, water quality and clarity in larger lakes, not to mention reducing pests and parasites.

WITHOUT AERATION

SIGNS OF IMBALANCE:

- Algae, opaque green water or excessive growth of string or blanket weed
- An excess of submerged vegetation and rampant marginal aquatic plant growth
- Foul odors, of the water or of the sediments at the bottom
- Dead fish, especially after a storm or a change to cooler weather
- Small, few or no live fish at all

CAUSES OF IMBALANCE:

- Excessive nutrients in the water and the sediment
- Insufficient total dissolved oxygen levels
- Stratification and thermoclines that cut off surface oxygen

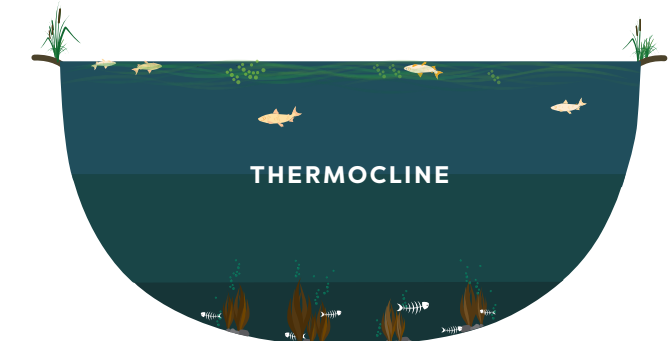

WITH AERATION

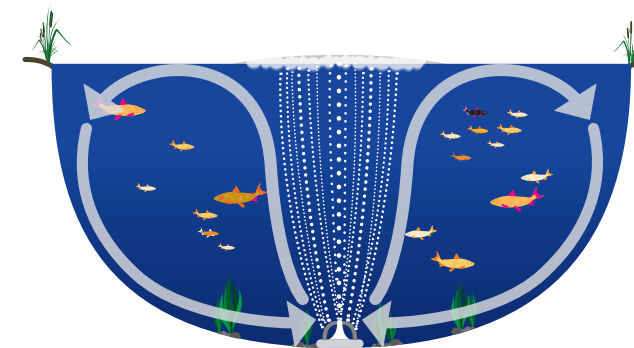

BENEFITS OF AERATION:

- Aeration creates bubbles that increase the surface area of air in contact with the water
- Millions of bubbles moving upwards pull huge volumes of water up from the bottom
- Oxygen-poor water rushes upwards, eliminating thermal layers, shedding toxic gases and picking up oxygen
- Oxygen-rich water circulates down to the bottom, promoting the growth of bacteria that digest organic sludge and eliminate excessive nutrients



DIFFUSERS & COMPRESSORS



TPSDIF

- Air Diffusers distribute compressed air to the bottom of the body of water where gas exchange and circulation are needed most
- Atlantic's Air Diffusers feature a streamlined body design and innovative diffuser tubing that circulates water more efficiently
- Extruded EPDM diffuser tubing proven in industrial applications offers tremendous longevity and resistance to fouling

TPDDIF

- Bubble sizes decrease as pressure rises; smaller bubbles maximize surface area for extremely efficient gas diffusion and circulation
- Easy to fill on-site with sand or gravel, Diffusers ship empty to save weight and freight
- Easily replaceable tubing and stainless steel hardware extends usable service life of Diffusers

| MODEL | ITEM | LIST | DESCRIPTION | FLOW RATE | DIMENSIONS | WARRANTY |
|--------|-------|----------|------------------------|--------------|---------------------|----------|
| TPSDIF | 73978 | \$178.99 | Shallow Water Diffuser | 15 - 75 LPM | 13½"L x 12"W x 8½"H | 5-year |
| TPDDIF | 73976 | \$224.99 | Deep Water Diffuser | 25 - 150 LPM | 18"L x 16"W x 10½"H | 5-year |

TYPHOON DIFFUSER FEATURES:

1. Heavy-walled diffuser tubing produces ultra-fine bubbles with little back pressure.
2. Diffuser shape accelerates the rising water column.
3. Full flow manifold evenly distributes air to the diffuser tubing.
4. Push-lock manifold connection simplifies servicing.
5. Integrated strain relief for ½" and ¾" weighted tubing.
6. Includes ¾" check valve, ¾" insert fitting and stainless steel strain relief bracket.



To convert Atlantic Aeration Systems to ½" Weighted Tubing see page 132.

SHALLOW WATER AIR COMPRESSORS



TPS200

- Compressors efficiently deliver pressurized air to specific depths
- Designed for the shallows, linear piston compressors combine the rugged reliability of a piston and cylinder system with the economy and simplicity of a magnetic motor

TPS400

- Fully rebuildable linear piston compressors last longer and require less maintenance than cheaper linear diaphragm systems
- Shallow Water Air Compressors each have 6' power cords

| MODEL | ITEM | LIST | VOLTS | AMPS | WATTS | OUTLET | MAX. PRESSURE | MAX DEPTH | DIMENSIONS | WARRANTY |
|--------|-------|----------|-------|------|-------|---------|---------------|-----------|-------------------|----------|
| TPS200 | 73974 | \$169.99 | 115 | 0.9 | 102 | ¾" FIPT | 5.1 psi | 6' | 10"L x 5½"W x 7"H | 2-year |
| TPS400 | 73975 | \$214.99 | 115 | 1.4 | 160 | ¾" FIPT | 5.8 psi | 7' | 11"L x 6"W x 8"H | 2-year |

| MODEL | | MAX | @2' | @4' | @6' | @8' | @10' | @12' |
|--------|-----------|-----------|-----------|-----------|-----------|----------|----------|----------|
| TPS200 | LPM / CFM | 110 / 3.9 | 85 / 3.0 | 65 / 2.3 | 50 / 1.8 | 35 / 1.2 | 15 / 0.5 | --- |
| TPS400 | LPM / CFM | 240 / 8.5 | 190 / 6.7 | 150 / 5.3 | 115 / 4.1 | 85 / 3.0 | 55 / 1.9 | 25 / 0.9 |

DEEP WATER AIR COMPRESSORS



TPD87R6

- Gast rocking piston Deep Water Air Compressors with high pressure output are the best choice for ponds from 8 to 35 feet deep
- Dual aluminum pistons, hard-coated cylinders and replaceable piston seals make these compact workhorses as long lasting as they are powerful
- Replaceable air filter keeps dust and abrasives out for longevity

TPD72R6

- Rubber mounting feet help keep these compressors as quiet as they are dependable
- Quiet, damped operation for minimum noise and vibration
- Rebuildable, with components easily accessible for simple maintenance and servicing
- Deep Water Air Compressors have 6' power cords

| MODEL | ITEM | LIST | VOLTS | AMPS | INLET | OUTLET | MAX. PRESSURE | MAX DEPTH | DIMENSIONS | INCLUDES | WARRANTY |
|---------|-------|----------|-------|------|---------|---------|---------------|-----------|--------------------|---------------|----------|
| TPD87R6 | 73973 | \$776.99 | 115 | 4.4 | ¼" FIPT | ¼" FIPT | 30 psi | 35' | 10"L x 6½"W x 7"H | Intake Filter | 2-year |
| TPD72R6 | 73972 | \$876.99 | 115 | 5 | ¼" FIPT | ¼" FIPT | 30 psi | 35' | 11"L x 7½"W x 7½"H | Intake Filter | 2-year |

| MODEL | | MAX | @10' | @15' | @20' | @25' | @30' | @35' |
|---------|-----------|-----------|-----------|-----------|-----------|-----------|-----------|-----------|
| TPD87R6 | LPM / CFM | 130 / 4.6 | 125 / 4.4 | 119 / 4.2 | 113 / 4 | 108 / 3.8 | 102 / 3.6 | 99 / 3.5 |
| TPD72R6 | LPM / CFM | 165 / 5.8 | 156 / 5.5 | 150 / 5.3 | 144 / 5.1 | 142 / 5 | 139 / 4.9 | 136 / 4.8 |



TUBING & TREATMENTS

WEIGHTED TUBING

- Atlantic's Tubing is made of the highest quality materials for long, trouble-free service life
- Thick-walled Weighted Tubing sinks without the inconvenience of adding weights to keep tubing from floating
- High density PVC formulation remains flexible in a wide range of temperatures
- Nickel-plated insert fittings, supplied with every roll, make connecting Weighted Tubing of different lengths simple and secure
- TPF12WT Fitting Kit available to convert Atlantic Diffusers and Aeration Cabinets to 1/2" weighted tubing for runs over 300 feet



| MODEL | ITEM | LIST | DESCRIPTION | I.D. | O.D. | WEIGHT | INCLUDES | WARRANTY |
|----------|--------|------------|---|------|-------|----------|--|----------|
| TPT38050 | 73983 | \$54.99 | 3/8" x 50' Weighted Tubing | 3/8" | 0.69" | 10 lbs. | 3/8" insert coupling | 5-year |
| TPT38100 | 73984 | \$106.99 | 3/8" x 100' Weighted Tubing | 3/8" | 0.69" | 20 lbs. | 3/8" insert coupling | 5-year |
| TPT38500 | 73985 | \$492.99 | 3/8" x 500' Weighted Tubing | 3/8" | 0.69" | 100 lbs. | 3/8" insert coupling | 5-year |
| TPT12050 | 73980 | \$111.99 | 1/2" x 50' Weighted Tubing | 1/2" | 0.97" | 19 lbs. | 1/2" insert coupling | 5-year |
| TPT12100 | 73981 | \$221.99 | 1/2" x 100' Weighted Tubing | 1/2" | 0.97" | 38 lbs. | 1/2" insert coupling | 5-year |
| TPT12500 | 73982 | \$1,053.99 | 1/2" x 500' Weighted Tubing | 1/2" | 0.97" | 190 lbs. | 1/2" insert coupling | 5-year |
| TPF12WT | 739977 | \$20.99 | Fitting Kit for 1/2" Weighted Tubing Conversion | --- | --- | --- | 1/2" MPT x 1/2" Insert & 3/4" MPT x 1/2" Insert Adapters | --- |

DIRECT BURIAL TUBING

- Low friction Direct Burial Tubing brings the air to the water's edge economically
- Tubing is made of UV-stabilized PVC for long life under the harshest conditions
- Push-lock fittings allow for quick, secure connection of Direct Burial Tubing between the Cabinet and the Weighted Tubing at the shoreline
- Tool-free connections simplify tubing installation



| MODEL | ITEM | LIST | SIZE | I.D. | O.D. | WEIGHT | INCLUDES | WARRANTY |
|----------|-------|---------|----------------------------------|------|------|---------|-----------------------------------|----------|
| TPB12100 | 73979 | \$66.99 | 1/2" x 100' Direct Burial Tubing | 3/8" | --- | 10 lbs. | 1/2" MPT / FPT Push-lock fittings | 5-year |

POND CLARIFIER

Custom bacterial strains clear pond water by consuming dissolved organics. Simply toss in appropriate number of 8 ounce water soluble packets each month for clear, clean water year round. Safe for fish, plants, livestock and pets.

| MODEL | ITEM | LIST | SIZE | DOSAGE | TREATS |
|---------|-------|----------|-----------------------|--|-------------------------------|
| TPWCP06 | 74076 | \$146.99 | 12 Packets 6 lbs. | 1 packet per 1/4 acre every two weeks | 1/4 acre pond for 6 months |
| TPWCP24 | 74077 | \$457.99 | 48 Packets 24 lbs. | 4 packets per acre every two weeks | 1 acre pond for 6 months |



POND CLARIFIER +TM

Concentrated bacteria in 3 ounce slow release tablets with double the colony forming units (CFUs) per gram, Pond Clarifier Plus Trace Minerals accelerates organic removal and improves overall pond health. Safe for fish, plants, livestock and pets.

| MODEL | ITEM | LIST | SIZE | DOSAGE | TREATS |
|---------|-------|----------|------------------------|---|-------------------------------|
| TPWPP06 | 74078 | \$176.99 | 32 Tablets 6 lbs. | 2 tablets per 1/4 acre every two weeks | 1/4 acre pond for 8 months |
| TPWPP24 | 74079 | \$544.99 | 128 Tablets 24 lbs. | 8 tablets per acre every two weeks | 1 acre pond for 8 months |



SLUDGE REMOVER

Easy to throw 1/2 ounce sludge eliminating tablets rapidly digest decomposing vegetation and fish waste. Plant and fish safe, perfect for wading and swimming areas. When regularly applied as directed to the shoreline, tablets can remove up to 5 inches of muck per year.

| MODEL | ITEM | LIST | SIZE | DOSAGE | TREATS |
|---------|-------|----------|------------------------|---|-------------------------------|
| TPWSR06 | 74080 | \$142.99 | 192 Tablets 6 lbs. | 16 tablets per 1000 sq. ft. every two weeks | 1,000 sq. ft. for 6 months |
| TPWSR24 | 74081 | \$369.99 | 768 Tablets 24 lbs. | 64 tablets per 4000 sq. ft. every two weeks | 4,000 sq. ft. for 6 months |



POND DYE

Whether you prefer liquid dye or easy to apply dissolvable packets of powdered dye, Typhoon Pond Dye shades the water to eliminate plant growth below the surface. Available in both blue and black, concentrated dye can be mixed to create your own favorite shade. Safe for fish, plants, livestock and pets.

| MODEL | ITEM | LIST | SIZE | DOSAGE | TREATS |
|----------|-------|---------|-----------|-----------------------------|-------------|
| TPWDBLU2 | 74090 | \$29.99 | 2 Packets | 1 packet per acre-foot | 1/2 acre |
| TPWDBLK2 | 74088 | | | | 4'- 6' deep |
| TPWDBLU4 | 74091 | \$54.99 | 4 Packets | 1 packet per acre-foot | 1 acre |
| TPWDBLK4 | 74089 | | | | 4'- 6' deep |
| TPWDBLUG | 74093 | \$48.99 | 1 gallon | 1/4 gallon per acre-foot | 1 acre |
| TPWDBLKG | 74092 | | | | 4'- 6' deep |





SHALLOW WATER AERATION

SHALLOW WATER AERATION CABINETS

- Includes Typhoon Linear Piston Shallow Water Compressor
- Easily adjusted locking manifold assemblies provide flow control to multiple Diffuser systems
- Heavy-duty Cabinets secure and protect components while muffling the sound of compressors
- Atlantic's Cabinets have a reinforced lockable lid and sturdy hinges with vandal resistant screws for secure installation
- Double walled for noise insulation and durability
- Integrated cooling fan keeps components from overheating under the harshest conditions
- Filtered air intake protects the compressor from dust and debris



TPS200C (shown)

| MODEL | ITEM | LIST | DESCRIPTION | WEIGHT | DIMENSIONS | POND DEPTH | INCLUDES | WARRANTY |
|---------|-------|----------|---------------------------------|---------|--------------------|---------------------|---|----------|
| TPS200C | 73964 | \$569.99 | 2-Outlet Shallow Water Assembly | 55 lbs. | 24"L x 22"W x 20"H | Ponds up to 6' deep | Cabinet with 2-outlet manifold and Linear Piston Compressor | 2-year |
| TPS400C | 73965 | \$679.99 | 4-Outlet Shallow Water Assembly | 60 lbs. | 24"L x 22"W x 20"H | Ponds up to 7' deep | Cabinet with 4-outlet manifold and Linear Piston Compressor | 2-year |

TYPHOON AERATION CABINET FEATURES:

1. Weatherproof, double walled Cabinet for strength and noise insulation.
2. Industrial hinges, rubber "T" hasp closures and stainless steel locking plates for maximum security and service life.
3. Aluminum manifold block with full flow ½" inlets and outlets, and flow adjusters.
4. High volume cooling fan in lid vents air through wall cavity for maximum cooling and minimum noise.
5. Large filtered air inlet at lower rear of cabinet for complete circulation.
6. PVC tubing with push lock quick release fittings.
7. Solid brass nickel plated fittings for maximum durability.



TPS400C (shown)

SHALLOW WATER AERATION SYSTEMS



TPS200S

TPS400S

- Shallow Water Aeration systems combine all of the components you need to aerate ponds and lakes up to 7' deep and a half acre in surface area
- Complete systems include Aeration Cabinet Assemblies with all subcomponents pre-installed, Shallow Water Diffusers, Weighted Tubing and all necessary fittings

DID YOU KNOW?

Ventilation is crucial for proper functioning of components inside of the Cabinet. An inlet at the bottom rear of the Cabinet allows air to be drawn in directly over the Air Compressor as it is pulled out by the fan at the top of the Cabinet, cooling the motor and prolonging the time between servicing.



| MODEL | ITEM | LIST | DESCRIPTION | FOR USE IN | COVERAGE AREA | INCLUDES | WARRANTY |
|---------|-------|------------|---|---------------|----------------------|--|----------|
| TPS200S | 73970 | \$1,165.99 | Shallow Water Aeration System with Two Diffusers | up to 6' deep | Up to ¼ surface acre | TPS200C Cabinet Assembly, (2) TPT38100 Weighted Tubing, (2) TPSDIF Shallow Water Diffusers | 2-year |
| TPS400S | 73971 | \$1,649.99 | Shallow Water Aeration System with Four Diffusers | up to 7' deep | Up to ½ surface acre | TPS400C Cabinet Assembly, (4) TPT38100 Weighted Tubing, (4) TPSDIF Shallow Water Diffusers | 2-year |

| MODEL | VOLTS | AMPS | WATTS | MAX LPM | MAX CFM | @2' | @4' | @6' |
|---------|-------|------|-------|---------|---------|--------|--------|--------|
| TPS200S | 115 | 0.9 | 112 | 110 | 3.9 | ¼ acre | ¼ acre | ¼ acre |
| TPS400S | 115 | 1.4 | 170 | 240 | 8.5 | ¼ acre | ½ acre | ½ acre |



DEEP WATER AERATION

DEEP WATER AERATION CABINETS

- Includes Gast rocking piston Deep Water Air Compressor
- Easily adjusted manifold assemblies provide flow control to multiple Diffuser systems
- Oil-filled pressure gauge and pressure relief valve monitor and protect compressor for enhanced reliability and longevity
- Heavy duty double-walled Cabinets secure and protect components while muffling the sound of compressors
- Atlantic's Cabinets have reinforced lockable lids and sturdy hinges with vandal-resistant screws for secure installation
- Integrated cooling fan keeps components from overheating under the harshest conditions
- Filtered air intake protects the compressor from dust and debris



TPD400C-72R6 (shown)

| MODEL | ITEM | LIST | DESCRIPTION | WEIGHT | DIMENSIONS | POND DEPTH | INCLUDES | WARRANTY |
|--------------|-------|------------|------------------------------|---------|--------------------|--------------------|--|----------|
| TPD100C-87R6 | 73960 | \$1,263.99 | 1-Outlet Deep Water Assembly | 60 lbs. | 24"L x 22"W x 20"H | Ponds over 8' Deep | Cabinet with 1-outlet manifold and Rocking Piston Compressor | 2-year |
| TPD200C-87R6 | 73961 | \$1,309.99 | 2-Outlet Deep Water Assembly | 60 lbs. | 24"L x 22"W x 20"H | Ponds over 8' Deep | Cabinet with 2-outlet manifold and Rocking Piston Compressor | 2-year |
| TPD300C-72R6 | 73962 | \$1,444.99 | 3-Outlet Deep Water Assembly | 72 lbs. | 24"L x 22"W x 20"H | Ponds over 8' Deep | Cabinet with 3-outlet manifold and Rocking Piston Compressor | 2-year |
| TPD400C-72R6 | 73963 | \$1,478.99 | 4-Outlet Deep Water Assembly | 72 lbs. | 24"L x 22"W x 20"H | Ponds over 8' Deep | Cabinet with 4-outlet manifold and Rocking Piston Compressor | 2-year |

DID YOU KNOW?

Aeration is a powerful tool. There are times when full implementation without an acclimation period can lead to disaster. In warm weather it is best to start slowly to avoid a "turnover", where deoxygenated bottom water is mixed in so quickly that total dissolved oxygen levels plummet to lethal levels. To be safe it's best to run the system for only 15 minutes the first day, 30 minutes the second, 1 hour on the third day, doubling the running time each day for the first week. This will also allow toxic methane and hydrogen sulfide to dissipate slowly and safely.



DEEP WATER AERATION SYSTEMS



TPD100S-87R6



TPD200S-87R6



TPD300S-72R6



TPD400S-72R6

- Atlantic's Deep Water Aeration Systems offer complete solutions for lakes up to 35' in depth and 4 surface acres in area
- Complete systems come with Aeration Cabinet Assemblies with all subcomponents pre-installed, Deep Water Diffusers, Weighted Tubing and all necessary fittings

| MODEL | ITEM | LIST | FOR USE WITH | COVERAGE AREA | INCLUDES | WARRANTY |
|--------------|-------|------------|---|-----------------------|--|----------|
| TPD100S-87R6 | 73966 | \$1,552.99 | Ponds and lakes between 8' and 35' deep | Up to 1 surface acre | TPD100C Cabinet Assembly, TPT38100 Weighted Tubing and TPDDIF Deep Water Diffuser | 2-year |
| TPD200S-87R6 | 73967 | \$1,904.99 | Ponds and lakes between 8' and 35' deep | Up to 2 surface acres | TPD200C Cabinet Assembly, (2) TPT38100 Weighted Tubing and (2) TPDDIF Deep Water Diffusers | 2-year |
| TPD300S-72R6 | 73968 | \$2,341.99 | Ponds and lakes between 8' and 35' deep | Up to 3 surface acres | TPD300C Cabinet Assembly, (3) TPT38100 Weighted Tubing and (3) TPDDIF Deep Water Diffusers | 2-year |
| TPD400S-72R6 | 73969 | \$2,680.99 | Ponds and lakes between 8' and 35' deep | Up to 4 surface acres | TPD400C Cabinet Assembly, (4) TPT38100 Weighted Tubing and (4) TPDDIF Deep Water Diffusers | 2-year |

| MODEL | VOLTS | AMPS | MAX LPM | MAX CFM | @8' | @12' | @16' | @20' |
|--------------|-------|------|---------|---------|--------|----------|----------|---------|
| TPD100S-87R6 | 115 | 4.5 | 130 | 4.6 | ¼ acre | ½ acre | ½ acre | 1 acre |
| TPD200S-87R6 | 115 | 4.5 | 130 | 4.6 | ½ acre | ¾ acre | 1 acre | 2 acres |
| TPD300S-72R6 | 115 | 5.1 | 165 | 5.8 | ¾ acre | 1 acre | 1½ acres | 3 acres |
| TPD400S-72R6 | 115 | 5.1 | 165 | 5.8 | 1 acre | 1½ acres | 2 acres | 4 acres |



FLOATING FOUNTAINS

PONDJET



- Floating fountains offer economical shallow water aeration combined with an attractive visual display
- OASE PondJet features a powerful submersible pump and integrated nozzle for a complete drop in solution, ready to install and connect in minutes
- Tethered float accommodates ponds that vary in water level
- Will work with any 1" OASE or Atlantic Nozzle for maximum display versatility
- Accessorize with PondJet Illumination Set to light your fountain with 3 powerful spotlights
- Includes pump, float and nozzle



| ITEM | LIST | DESCRIPTION | VOLT | WATTS | MAX PRESSURE | MAX FLOW | CORD | DIMENSIONS | WARRANTY |
|-------|------------|---------------------------|------|-------|--------------|----------|------|-------------|----------|
| 54019 | \$1,231.99 | PondJet Floating Fountain | 120 | 260 | 10psi | 2400 gph | 75' | 26"W x 21"H | 3-year |

PONDJET ILLUMINATION SET

- Floating fountain illumination creates dazzling nighttime effects
- OASE PondJet Illumination Set features 3 powerful 50 watt halogen bulbs with a 24 degree beam angle for optimal spotlighting
- Bulbs may be upgraded to optional 75 watt halogen
- Includes 3 LunAqua 10 warm white Spotlights with 3' cords, 3 stainless steel mounting brackets, 12 volt Underwater Transformer with mounting bracket and 75' cord



| ITEM | LIST | DESCRIPTION | WATTS | INPUT | WARRANTY |
|-------|----------|--------------------------|-------|------------|----------|
| 51071 | \$614.99 | PondJet Illumination Set | 150 | 12 volt AC | 2-year |

TECH TIP

Accessorize your PondJet with any of our many 1" Nozzles for the widest variety of decorative displays. PondJet accepts 1" MIPT nozzles without modification. Use a 1" close nipple to adapt PondJet to any 1" FIPT Nozzle. See page 16-19 for full selections.



FLOATING FOUNTAIN WITH LIGHTS



45383

- Floating fountains offer economical shallow water aeration combined with an attractive visual display
- OASE Floating Fountains with Lights are compact, reliable and energy efficient
- Each Floating Fountain comes complete and ready to connect
- Designed for use in smaller water features with a minimum depth of 30"
- 3 LED spotlight illumination set brings the various water patterns to life after dark via optional photocell
- Choose from 3 ornamental nozzle attachments - Trumpet, Single Tier and 3-Tier

45393

- Grounding plate eliminates any chance of stray current entering water for unparalleled safety
- Coated magnetic rotors are impervious to adverse water conditions
- Self-cooling, debris flushing rotor chambers keep pumps from overheating in the most demanding applications
- Tool-less volute removal makes maintenance fast and easy
- Nylon jacket on power cord keeps line from tangling (1/2 HP only)
- Includes pump, float body, mooring lines, pump shield, stainless steel mooring anchors, lights and 3 nozzles

| ITEM | LIST | DESCRIPTION | VOLTS | WATTS | MAX HEIGHT | MAX FLOW | MOORING LINE | CORD | DIMENSIONS | WARRANTY |
|-------|------------|--------------------------------------|-------|-------|------------|----------|--------------|------|--------------|----------|
| 45383 | \$489.99 | Floating Fountain with Lights 1/4 HP | 120 | 130 | 10' | 2300 gph | 100' | 50' | 14½"W x 19"H | 3-year |
| 45393 | \$1,103.99 | Floating Fountain with Lights 1/2 HP | 120 | 230 | 14' | 5150 gph | 150' | 75' | 23"W x 16¼"H | 3-year |

NOZZLE PATTERNS

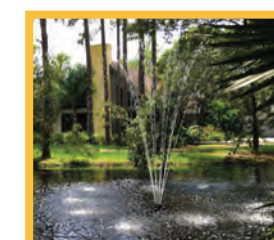

| MODEL | TRUMPET | | SINGLE TIER | | 3-TIER | |
|--------|---------|--------|-------------|--------|--------|--------|
| | SPREAD | HEIGHT | SPREAD | HEIGHT | SPREAD | HEIGHT |
| 1/4 HP | 16' | 3' | 16' | 10' | 6' | 10' |
| 1/2 HP | 23' | 5' | 28' | 12' | 9' | 12' |

RAIN HARVESTING

Whether you're considering a single rain barrel or a large in-ground reservoir, Atlantic's innovative Rain Harvesting components are right for your project. Our Clean Rain Ultra Downspout Diverter, Eco-Blox and Rain Harvesting Pump Vault are all specially designed to capture, store and re-use rain water, allowing you to help the planet by reducing runoff while saving money on your water bill.

- » Rain Water Harvesting is a responsible solution to many irrigation and runoff containment dilemmas
- » First flush diverters automatically direct contaminated roof water to waste before allowing clean water to fill cisterns and reservoirs
- » Pump Vaults house and protect the external and submersible pumps and plumbing that distribute harvested water
- » Eco-Blox water matrices provide a fully modular containment solution to create underground reservoirs of any size, shape or depth
- » Half- and full-sized Rain Barrels effectively collect and store water directly at the downspout



CLEAN RAIN ULTRA

clean rain™
downspout diverter **ULTRA**



CLEAN RAIN FEATURES:

1. Hydro Activated Filtration™ technology uses the rainwater's force to deflect leaves and debris off the screen.
2. The cover and cap provide a stylish, integrated finish and in colder climates, avert snow and ice blockage.
3. An easily accessible on/off switch bypasses collection and delivers rainwater to normal downspout.
4. Specially designed overflow mechanism directs excess water safely down your downspout.
5. Smart Sense™ First Flush feature ensures the majority of contaminants from the roof are flushed down the downspout.
6. Smart Sense™ self regulating valve automatically adjusts to divert the optimum amount of dirty rainwater to waste based on the intensity of the rainfall event.
7. Washers that swell with rainwater dry out to reset Clean Rain Ultra automatically after every rainfall.
8. The hose outlet fits standard garden, pool and sump hoses and the cap removes to fit 3" Schedule 40 pipe.

hydro activated™
FILTRATION TECHNOLOGY

smart sense™
FIRST FLUSH



| MODEL | ITEM | LIST | INLET / OUTLET | DIVERTER OUTLET | DIMENSIONS | WARRANTY |
|-------|-------|----------|---|--------------------------------------|-------------------|----------|
| RHCRU | 74257 | \$108.99 | 2" x 3" and 3" x 4" downspout - 3" and 4" Sch 40 | Garden hose, flex pipe and 3" Sch 40 | 8¼"L x 9"W x 31"H | 1-year |

Downspout Adaptors Included

Fits 2" x 3", 3" x 4" and 3", 4" downspouts

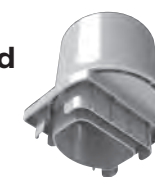

2" x 3" & 3" x 4"



3" and 4" round
Sch 40 pipe

Compatible Hoses

Also fits 3" Schedule 40 pipe

Garden Hose



Standard

Sump Hose



1"

Pool Hose



1½"



RAIN HARVESTING PRODUCTS

SUBMERSIBLE ON-DEMAND PRESSURE PUMP

- Extremely reliable and easy to install
- Built-in pressure switch and flow sensor
- Equipped with run-dry protection and internal check valve
- Automatically starts and stops when taps are opened
- Delivers constant pressure and flow rates
- 1" FIPT outlet and 48' power cord



| MODEL | ITEM | LIST | VOLTS | WATTS | MAX FLOW | MAX PRESSURE | DIMENSIONS | WARRANTY |
|---------|-------|------------|-------|-------|----------|--------------|------------------|----------|
| RHDIV12 | 74258 | \$1,005.99 | 115 | 1100 | 29 gpm | 65 psi | 6"L x 6"W x 19"H | 1-year |

EXTERNAL ON-DEMAND PRESSURE PUMP

- Quiet, self-priming, water-cooled
- Built-in pressure switch and flow sensor
- Equipped with run-dry protection and internal check valve
- Automatically starts and stops when taps are opened
- Delivers constant pressure and flow rates
- 1" MIPT outlet and 5' power cord



| MODEL | ITEM | LIST | VOLTS | WATTS | MAX FLOW | MAX PRESSURE | DIMENSIONS | WARRANTY |
|---------|-------|------------|-------|-------|----------|--------------|--------------------|----------|
| RHEBS10 | 74259 | \$1,005.99 | 115 | 1000 | 22 gpm | 64 psi | 18"L x 11"W x 13"H | 1-year |

| MODEL | MAX FLOW | 20' | 40' | 60' | 80' | 100' | 120' | 140' | 160' | 180' |
|---------|----------|-----|-----|-----|------|------|------|------|------|------|
| RHDIV12 | 29 GPM | 26 | 23 | 20 | 17 | 13 | 8.5 | 3.5 | | |
| RHEBS10 | 22 GPM | 21 | 19 | 16 | 13.5 | 12 | 7 | 2 | | |

HOW IT WORKS:

Rainwater is intercepted in the downspout by the Clean Rain Ultra Downspout Diverter, which removes leaves, screens dirt and debris from the water and allows the first 10 to 15 gallons of rain to flush the roof clean. As the first flush passes through, a stack of washers swells, tripping a valve and diverting clean water to the reservoir for future use.

Additional Eco-Blox information on page 38.



RAIN HARVESTING PUMP VAULT

- Vaults house and protect pumps and plumbing in a single location to facilitate maintenance
- Atlantic's Rain Harvesting Pump Vault accommodates submersible and external pumps, adjacent and remote reservoir locations and a variety of installation options
- Sturdy ribbed construction keeps buried vaults from crushing or deforming underground



| MODEL | ITEM | LIST | MAX PUMP FLOW | OPENING | INLET | DIMENSIONS | DISCHARGE | WARRANTY |
|-------|-------|----------|---------------|---------|-------------|--------------------|-----------|----------|
| RHPV | 74256 | \$403.99 | 7,500 GPH | 9½" | (2) 3" FIPT | 20"L x 11"W x 48"H | 1" FIPT | Lifetime |

RAIN HARVESTING PUMP VAULT FEATURES:



- Twist lock lids allow safe, easy access to the pump chamber and 3" tank gauge riser (Tank Gauge optional).
- Comes with a 1" FIPT Spinweld® fitting for a pressure pump discharge and flat panels for additional plumbing.
- (2) 3" FIPT inlets allow installation inside the liner or out, via 3" lines and bulkhead fittings to remote Eco-Blox cistern.
- Built-in tank gauge riser and lid access extensions allow for 13" of backfill and can be removed for Pond-free installations.
- Equipped with flat panels for installing additional pump lines, downspout diverters and overflows.

TYPICAL INSTALLATION:

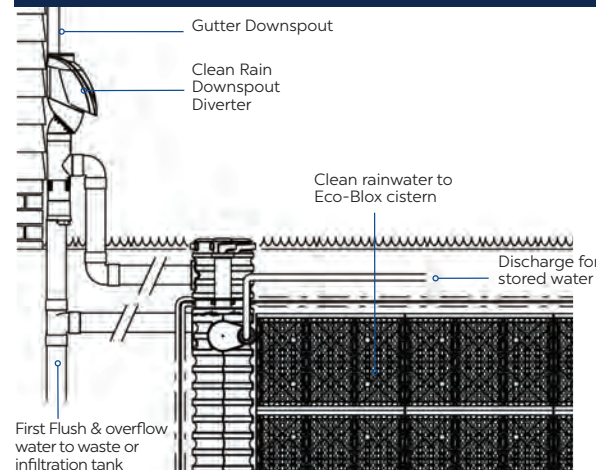

POND-FREE INSTALLATION:

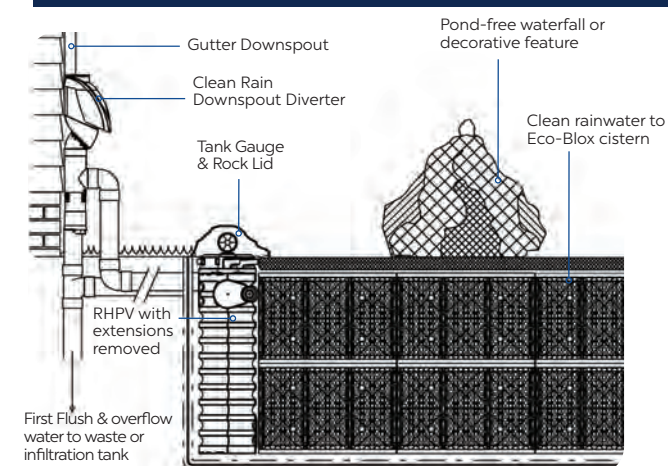

PAVER STONE WITH REMOTE PUMP VAULT INSTALLATION:

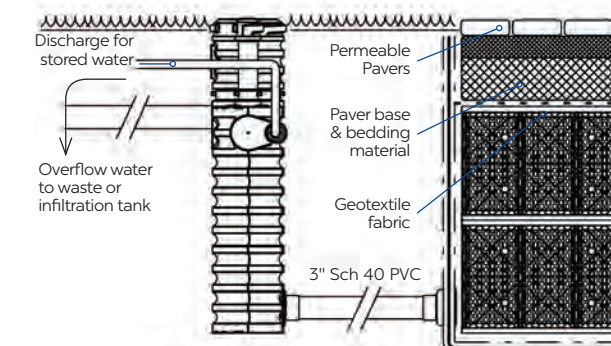

Vaults can be located adjacent to the reservoir or remotely. For remote installations use dual 3" pipes between the Pump Vault and the reservoir. Flow capacity decreases as the distance between the vault and reservoir increases.

| PIPE LENGTH | MAX FLOW |
|-------------|-----------|
| 10' | 6,500 gph |
| 20' | 5,000 gph |
| 30' | 2,000 gph |



RAIN HARVESTING PRODUCTS

RAIN HARVESTING KIT WITH RHDIV12

Atlantic's Rain Harvesting Kit with submersible on-demand pump provides everything you need to store and distribute up to 1000 gallons of harvested water.

INCLUDES:

- RHDIV12 Submersible Pressure Pump
- Clean Rain Ultra Downspout Diverter
- Rain Harvesting Pump Vault
- 45mil EPDM pond liner
- Heavy-duty underlayment
- Tank Gauge
- Eco-Blox
- Fittings



| MODEL | ITEM | LIST | CAPACITY | LINER SIZE | UNDERLAYMENT SIZE | ECO-BLOX | WARRANTY |
|--------------|-------|------------|---------------|------------|-------------------|----------|----------|
| RHKIT500DIV | 74266 | \$2,695.99 | 504 gallons | 15' x 20' | (2) 12' x 25' | 16 | 1-year |
| RHKIT1000DIV | 74264 | \$3,753.99 | 1,008 gallons | 20' x 25' | (4) 12' x 25' | 32 | 1-year |

RAIN HARVESTING KIT WITH RHEBS10

The RHEBS10 pump included in these Rain Harvesting Kits allows mounting and monitoring an on-demand pump for those situations where maintenance of an external pump is desired.

INCLUDES:

- RHEBS10 External Pressure Pump
- Clean Rain Ultra Downspout Diverter
- Rain Harvesting Pump Vault
- 45mil EPDM pond liner
- Heavy-duty underlayment
- Tank Gauge
- Eco-Blox
- Fittings



| MODEL | ITEM | LIST | CAPACITY | LINER SIZE | UNDERLAYMENT SIZE | ECO-BLOX | WARRANTY |
|--------------|-------|------------|---------------|------------|-------------------|----------|----------|
| RHKIT500EBS | 74267 | \$2,695.99 | 504 gallons | 15' x 20' | (2) 12' x 25' | 16 | 1-year |
| RHKIT1000EBS | 74265 | \$3,753.99 | 1,008 gallons | 20' x 25' | (4) 12' x 25' | 32 | 1-year |

LEAF EATER

Attach a Leaf Eater to your downspout to ensure that no debris enters your basin. Easy to install, with a stainless steel mosquito-proof screen and pivoting outlet for either rear or bottom discharge, the Leaf Eater is both simple and effective.

- Compact, versatile rain head is easy to install
- Prevents debris from entering the basin
- Outlet pivots for rear or bottom discharge
- Includes stainless steel mosquito-proof screen



| MODEL | ITEM | LIST | OUTLET | FOR USE WITH | DIMENSIONS | WARRANTY |
|-------|-------|---------|-----------|--------------|--------------------|----------|
| RHLE | 74260 | \$62.99 | 3" Sch 40 | Downspout | 7½"L x 6½"W x 9½"H | 1-year |

TANK GAUGE

Atlantic's Tank Gauge allows you to easily monitor the water level in your basin, and installs easily into any Atlantic Pump Vault.

- Monitors water level of any storage system
- Quick and easy to install, suitable for all new and existing tanks
- Easy-to-read dial face with empty and full indicators
- Can be calibrated for holding systems up to 8' deep



| MODEL | ITEM | LIST | OUTLET | FOR USE WITH | DIMENSIONS | WARRANTY |
|-------|-------|---------|------------------------------------|--------------|--------------------|----------|
| RHTG | 74263 | \$47.99 | Requires 1¼" hole for installation | RHPV | 3¼"L x 2¼"W x 4½"H | 1-year |

RAIN BARRELS

Sturdy, durable and attractive, Atlantic's Rain Barrels are perfect for those who want to store rainwater without excavating a below-ground basin. Available in 110 gallon full-sized barrels and 55 gallon half-barrels that nestle up perfectly to the side of your house, these Barrels make storing and accessing rainwater easier than ever.

- Rain Barrels store rain water directly at the base of a house mounted downspout
- Atlantic's Rain Barrels are made of UV protected PVC in an attractive pebble finish to complement any outdoor space
- Sturdy Rain Barrels are impervious to weather and freezing temperatures
- Convenient outlet located at bottom of barrel connects to any ¾" MIPT fitting
- Built-in overflow fitting allows barrels to be connected together for greater storage
- Top of Barrels can be planted to blend into landscaping



RHRB055

RHRB110

| MODEL | ITEM | LIST | DESCRIPTION | CAPACITY | TOP INLET | SIDE INLET | OUTLET | DIMENSIONS | WARRANTY |
|---------|-------|----------|------------------|-------------|-----------|-------------|---------|--------------------|----------|
| RHRB055 | 74261 | \$262.99 | Half Rain Barrel | 55 gallons | 4" pipe | (2) ¾" FIPT | ¾" FIPT | 29"L x 16"W x 44"H | 1-year |
| RHRB110 | 74262 | \$314.99 | Rain Barrel | 110 gallons | 4" pipe | (2) ¾" FIPT | ¾" FIPT | 31"L x 32"W x 44"H | 1-year |

TECHNICAL DATA

BLUE = ACTION

OASE products have specific components that are designed to be adjusted, opened or maintained. These parts are colored blue to indicate exactly where to interact with the product, such as flow control adjustment, tubing connections, locking clips, manual cleaning handles and nozzle adjustment fittings.



F

FOUNTAIN

FOUNTAIN BASIN SYSTEM

For features up to 1,200 pounds per Basin

SIZING PUMPS FOR OVERFLOWING FOUNTAINS:

Provide 10-20 gph per inch of active edge (where water is actively overflowing) for bubbling rocks, overflowing vases and basins:

10 - 20 gph x diameter in inches x 3.14

For example:

400-800 gph for 12" fountain diameter, 600-1200 gph for 18" diameter
800-1600 for 24" diameter, 1200-2400 for 36" diameter

*Rougher surfaces require greater flows but may splash more

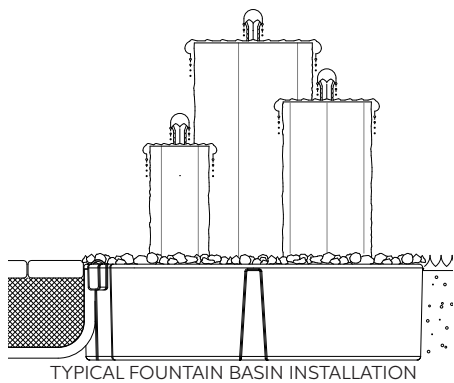

ECO-RISE SYSTEM

For multiple features up to 3,000 pounds per Eco-Rise, set directly over Eco-Blox reservoirs.

FOR UP TO 6 FEATURES:

To supply up to 6 individual features with 400-500 gph each, use 3/4" tubing from up to two 3-way Diverters fed by up to two TT3000 pumps per PV1700 Pump Vault.

FOR LARGER DIAMETER FEATURES:

To supply larger diameter features with up to 2000 gph each, use 1 1/2" tubing to TT3000 pumps, up to two per PV1700 Pump Vault.

ECO-RISE SYSTEM INSTALLATION:

Each Eco-Rise supports up to 3,000 pounds, while the Eco-Blox that create the reservoir can support up to 15000 pounds of distributed load when installed according to directions. For decorative elements, use multiple Eco-Rise units underneath larger pieces as needed.

- Use one PV1700 Pump Vault for up to six individual pieces. More than six pieces can be accommodated by multiple PV1700 Pump Vaults.

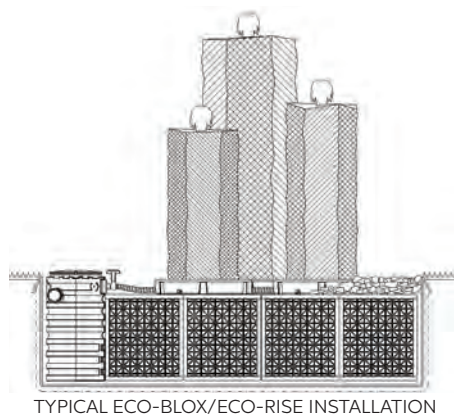

FOUNTAIN SPLASH CONTROL

- Typical splash zone extends from the source as far out as the feature is tall. A feature 3' tall may splash out 3' in every direction, a 6' diameter splash zone.
- For in-ground installations, use a liner skirt set to return splash to the basin. A liner skirt can be constructed by placing a piece of liner on top of the basin extending as far in every direction as the fountain piece is tall. A hole is then cut in the section of liner over the fountain basin (creating a 'donut') to allow splash to return to the basin.
- Alternately, place a Splash Mat on the horizontal surface where water is splashing to capture and suppress any splash that falls on the Mat. Splash Mat CFSPMA2820 may be purchased in rolls of 28"W x 20'L. See page 25.
- With all Fountain Systems, the use of an Auto Fill AF1000 to compensate for splash and evaporation losses is strongly recommended. See page 93.

TECHNICAL DATA

LIGHTING:

- For Atlantic Basalt Columns and cored boulders with 2" bore holes, use the Fountain Light WWFL2 or CCFL2 in your choice of Color Changing or Warm White to illuminate the water coming out of the top of the stone for a 'liquid torch' effect.
- For ceramic vase and bowl installations, use a Ring Light CCRL5 or WWRL5 at the bottom of the bowl to illuminate the water inside the vase and cast rippling light into overhanging structures.
- The lights inside bowls or stones may be easily synchronized with external Spotlights and Hardscape Lights to extend the effects into the surrounding landscape or hardscape.

COPPER BOWLS

USED SINGLY:

Set the Copper Fountain Bowl or Copper Spillway Bowl on the smooth, level surface it will be sitting on and mark the center where the 1/2" supply pipe will enter from below. Provisions should be made for the bowl to be removed for winterizing or servicing. Plan for access to a rubber coupling or union in the column or on top of a horizontal basin. For access to the coupling inside a block column, leave a capstone or block free of adhesive so it can be removed and replaced, or provide a removable door or panel. If using the bowl on a horizontal basin or reservoir, an Eco-Rise may be set under the bowl to provide space for the 1/2" supply pipe to elbow out to the side for easy access to the coupling or union. Alternately, place two 2" x 8" x 8" solid blocks side by side with space for the supply pipe in the middle.

TANDEM INSTALLATION:

To use the 26" Round or Square Spillway Bowls set on the Copper Pedestal spilling into the 36" Copper Fountain Bowl, provisions need to be made to provide space for both bowls to be plumbed with 1/2" supply pipes. One way to accomplish this is to use solid CMU block set on an Eco-Blox reservoir, with an oversize liner to provide a skirt to capture splash. Build an Eco-Blox reservoir with three Eco-Blox and a PV1700 Pump Vault, with the Eco-Blox 6" below existing grade. Set Pump Vault at the corner of the reservoir opposite the 36" Bowl and adjacent to the 26" Bowl and Pedestal. Use a 10' x 15' liner so the excess around the edges can set to capture splash. Install a 1 1/2" MIPT by slip elbow in the center inlet of the 36" Bowl, using Teflon tape. Set the base 36" Bowl on two 2" x 8" x 16" solid CMU blocks side by side 3" apart, with the elbow facing the Vault. The top of the Bowl overhanging the side of the reservoir. Set the 26" Bowl and Pedestal on two 2" x 8" x 16" solid CMU blocks 3" apart on the corner adjacent to the Pump Vault. Align the space between the blocks parallel to the flat side of the Vault.

Plumb a TT4000 pump in the vault with 2" Sch 40 PVC Flex Pipe, using a 90° elbow to exit vault. Install a 2" Tee Fitting and two 2" x 1 1/2" reducing bushings. Install one 1 1/2" line with a 1 1/2" valve from the tee to the elbow under the 36" Bowl. Install the second 1 1/2" line and valve to the bottom of the Spillway Bowl, passing through the 9" pedestal supporting the bowl. Adjust the flow to the Spillway Bowl by closing the valve to the 36" Copper Fountain Bowl.

Slope the area around the reservoir so any splash will return to the reservoir, then cover the liner and reservoir with decorative stone or gravel. If you wish to use a light inside the bowl use the Cord Seal Fitting (CSEAL15) to run the electrical cord through a 1 1/2" male adapter on the other inlet at the bottom of the bowl.

The Copper Fountain and Spillway Bowls have a thin lacquer coating to prevent unwanted tarnishing but will develop a natural dark patina over time. The original bright copper finish may be maintained or restored with a good quality non-abrasive copper cleaner. Apply as needed according to manufacturer's recommendations. Do not use where copper polish may affect fish.

FLEX BASIN

INSTALLING A PUMP IN A FLEXIBLE FOUNTAIN BASIN:

Atlantic 4'x4', 4'x6', 4'x8' rectangular and 4', 6' and 8' round Flexible Fountain Basins are equipped with integrated cord chases to hide pump and light cords. One runs across the bottom 2" from the vertical wall to 12" from the center of the reservoir. A second chase runs up the vertical wall from 2" above the bottom of the reservoir. This allows the pump to be set in the center of the reservoir with a pump nozzle attached directly to the outlet of the pump. The cord will exit the wall supporting the reservoir between the last vertical course of wall stone and the cap.

To pass the electrical cord of the pump through the wall instead, install a bulkhead fitting to the side of the vertical cord chase. Using an 1 1/2" MIPT x slip male adapter, run a length of conduit through the wall. Installation may require notching the interior of the wallstone to accommodate the thickness of the bulkhead fitting so the liner will lay flat. Pass the cord through the horizontal cord chase, the bulkhead fitting and the conduit. Use a Cord Seal Fitting in the male adapter to seal around the cord and prevent any leakage. Construct wall as needed to hide conduit through wall.

FOUNTAIN NOZZLES

CALCULATING PUMP REQUIREMENTS FOR MULTIPLE NOZZLES

For multiple nozzles add up the volume that each nozzle requires. Determine which nozzle requires the highest pressure. The pump chosen will need to provide the total volume at that highest pressure. For example, if three nozzles require 1200 gph at 4 psi, 2400 gph at 6 psi and 3600 gph at 2 psi respectively, you will need a pump that provides 7200 gph at 6 psi.

The specification table for each Fountain Nozzle gives the recommended range of flow and pressure for each. Overdriving the volume or the pressure will not significantly increase the maximum height or width of the display but will cost more to operate and put more stress on the system.

In order to avoid frequent nozzle clogging, the largest particles passing through the pump should be significantly smaller than the smallest orifice on the nozzle. Inlet screening and/or filtration may be required.

TECHNICAL DATA

USING LIGHT RING TO ILLUMINATE DISPLAY FROM FOUNTAIN NOZZLES

To illuminate the display from an 1½" nozzle install an 1½" adapter at the appropriate height on the 1½" riser attached to the outlet of the pump. Slip the Ring Light over the male adapter before attaching the nozzle.

To illuminate the display from a 1" nozzle, create a base for an Atlantic Ring Light by installing a 1" x 1½" reducing adapter on the 1½" riser attached to the outlet of the pump. Adapter should be set at the height appropriate for the nozzle. Install 1" bushing on Light Ring (included with light) and slip the Light Ring over the 1" adapter before attaching the nozzle.

LEVELING NOZZLES

The stainless steel Nozzle Adjustment Base is designed to level Fountain Nozzles that are up to 15 degrees off vertical. Adjustment is best done on a calm day when the wind will not throw off the procedure. Begin by adjusting all screws to leave a ¼" gap between the top and bottom plates. Install the Nozzle Adjustment Base on the pump or plumbing, then attach the nozzle to the Base. Set the pump or plumbing in position and ensure that it is stable and will not move when the pump is in operation. Turn on the pump and note the direction that the water "leans". Turn off the pump and back out the screw closest to the direction of 'lean', counterclockwise, noting the number of turns. Repeat as necessary to plumb the water column. If water column 'lean' is centered between two adjustment screws, adjust both as needed to correct.

FS

FORMAL SPILLWAY

STAINLESS STEEL & COPPER FINISH SPILLWAY INSTALLATION

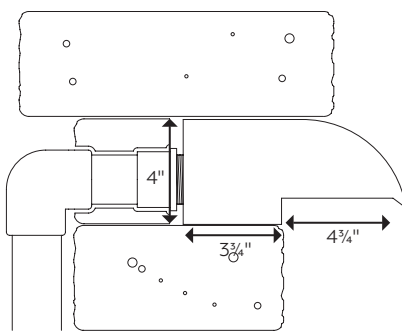

- Spillways are sized to exactly replace 4" tall block
- Load bearing capacity of Spillways is 80 lbs. per linear foot
- Heavier water sheer of Spillways allows taller waterfall height of up to four feet above basin level
- 304 Stainless Steel is not compatible with chlorinated or salt water pools
- 316 Stainless Steel Spillways are for use wherever chlorine is used as a disinfecting agent

LIGHTING OPTIONS:

- Because the water flow coming out of the Spillways is not laminar, they cannot be lit from within like Colorfalls and Wall Spouts
- To illuminate Spillways, either uplight by placing a Ring Light or Bar Light directly below the falls or downlight by installing wall lights below the Spillway

WALL SPOUT INSTALLATION

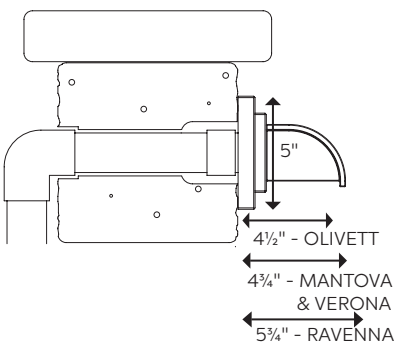

- Wall Spouts should protrude at least 2" over the catch basin
- Integrated drip edge ensures any drip falls straight down preventing water from running back, dampening retaining wall
- Allow for the plumbing to be adjusted backwards to snug the spout against the wall, or caulk small gap between Spout and wall
- Flows under 600 gph will not allow Spout Light to illuminate water flow if used

LIGHTING OPTIONS:

- To light the laminar flow of water coming out of a wall spout, install an 1½" tee fitting to supply water to the fixture fitted with a 1½" x 1" threaded bushing to accept a Warm White or Color Changing Spout Light
- With a minimum of 600 gallons per hour flow, the light will be fully encapsulated within the water illuminating the stream as it travels down to the basin

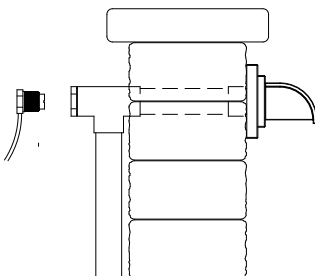

TECHNICAL DATA

WATERWALL SPILLWAY INSTALLATION

- For framed wall installations, WaterWall Spillway installs on top of framed walls leaving 2" for concrete backer board and fascia
- Liner should cover framing and extend at least 18" to either side of WaterWall
- Bottom of liner must overlap edge of pump basin or reservoir
- Use ball valve on pump to adjust flow
- For masonry installations, a channel may be cut into the course of block below the WaterWall to accommodate 1½" pipe and fittings

LIGHTING OPTIONS:

- Two Spotlights submerged at either corner of reservoir will cast light on water cascading down wall enhancing the appearance of movement

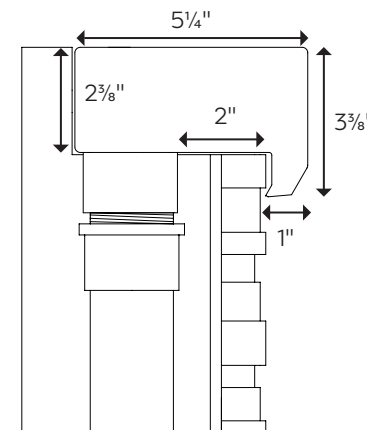

COPPER SPILLWAY BOWL INSTALLATION:

- Cap and one block in top course need to be removable to access rubber coupling
- Ensure that the spillway lip clears the column to avoid excessive splash and water loss
- For best results and the least amount of water loss, bowl height above reservoir should not exceed 3'

LIGHTING OPTIONS:

- Use Ring Light around included copper standpipe to illuminate interior of bowl
- Use Cord Seal Fitting in second inlet to pass light cord through bottom of bowl

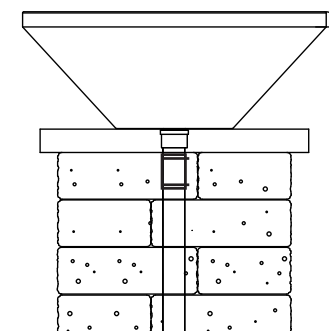

COLOR CHANGING COLORFALLS INSTALLATION:

- Colorfalls must be supported evenly both above and below the lip as shown
- Lip overhang should not exceed 1" to avoid algae issues, warping and loss of support
- Load bearing capacity of Colorfalls is 40 lbs. per linear foot
- For best results and the least amount of water loss, falls should not exceed max heights listed on pages 21 and 22

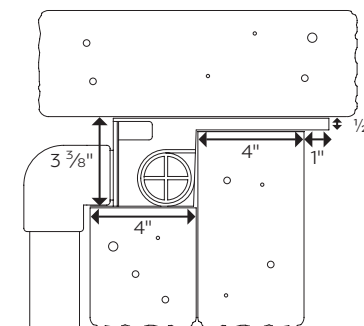

CONNECTING MULTIPLE COLOR CHANGING COLORFALLS

STEP 1.



Use included 1½" threaded coupling to attach multiple Colorfalls together.

STEP 2.

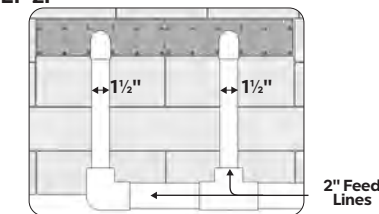

Plumb Colorfalls with 2" manifold or install valves to distribute water equally to all units.

STEP 3.

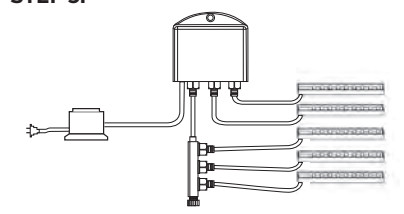

Use Splitters (CCBSX4) and InfiColor 3-Light Wiring Kit (CCSM30X3) and larger Transformer to link and sync Color Changing Colorfalls.

Tip: Plumb directly into the back center of each unit. Plumbing multiple Colorfalls unevenly favoring one side will produce an uneven water sheer.

INFICOLOR SMART MODULE & APP:

See page 157 for more information on InfiColor App and connecting first and second generation Color Changing products.

TECHNICAL DATA

FORMAL SPILLWAY AND FLEXIBLE BASIN INSTALLS & PLUMBING CONFIGURATIONS

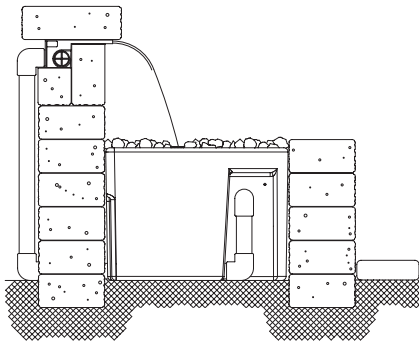

COLORFALLS WITH FORMAL SPILLWAY BASIN

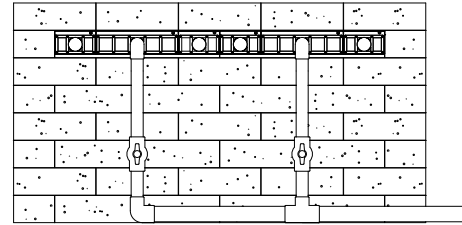

MULTIPLE COLORFALLS INSTALLATION IN CUSTOM BASIN

To feed multiple Colorfalls create a manifold of 2" pipe with 1/2" risers and valves to balance the flow to two or three Colorfalls. For total flows under 3000 gallons per hour, a single pump may be used; to feed multiple 24" or 36" Colorfalls install a pump at either end of the manifold.

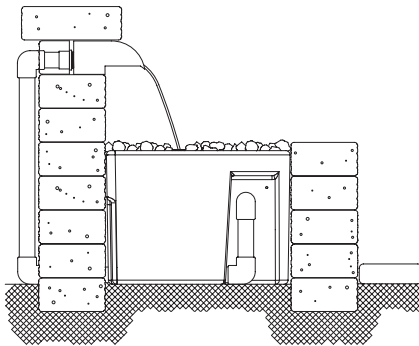

SPILLWAY WITH FORMAL SPILLWAY BASIN

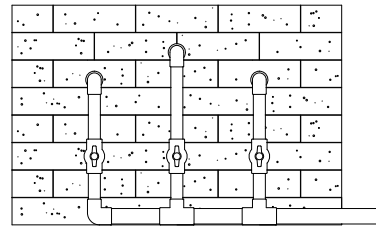

MULTIPLE SPILLWAYS WITH FORMAL SPILLWAY BASIN

To feed multiple spillways create a manifold of 2" pipe with 1/2" risers and valves to balance the flow to two or three spillways. For total flows under 3000 gallons per hour, a single pump may be used; to feed multiple spillways install a pump at either end of the manifold.

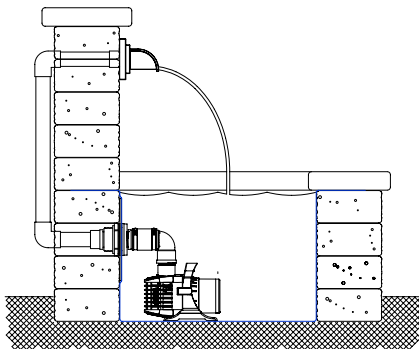

WALL SPOUT WITH FLEXIBLE HARDSCAPE BASIN

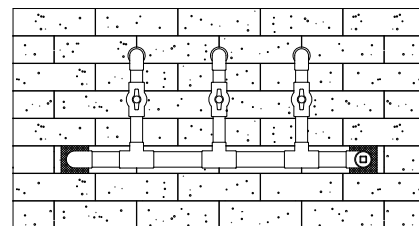

MULTIPLE SPOUT INSTALLATION IN CUSTOM BASIN

To feed multiple spouts create a manifold of 2" pipe with 1/2" risers and valves to balance the flow to two or three spouts. For total flows under 3000 gallons per hour, a single pump may be used; for flows over 3000 gallons per hour, install a pump at either end of the manifold.

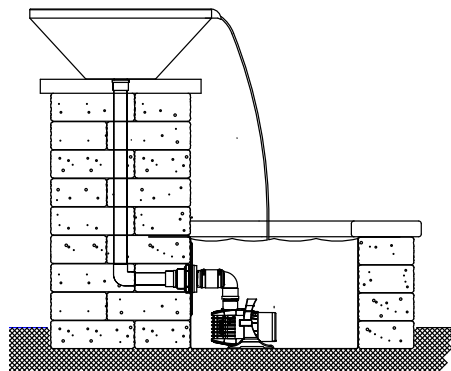

COPPER SPILLWAY BOWL WITH FLEXIBLE HARDSCAPE BASIN

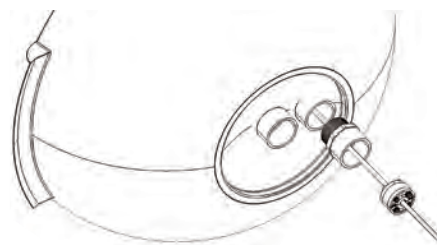

CORD SEAL FITTING INSTALLATION

To install Copper Spillway Bowl run plumbing to center inlet and seal secondary inlet with included 1/2" Sch40 PVC plug using silicone or tape on threads. If lighting is desired, install 1/2" Sch40 PVC male adapter included with Cord Seal Fitting (CSEAL15) in secondary inlet as shown and use Cord Seal Fitting to seal around lighting cord.

TECHNICAL DATA



POND-FREE

CALCULATING BASIN VOLUME

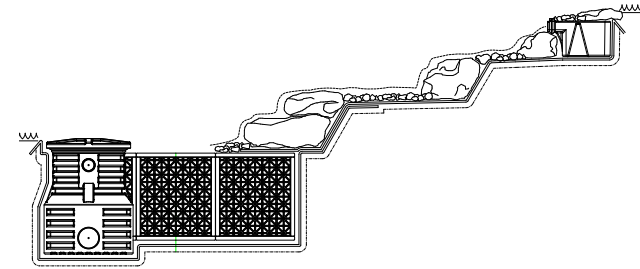

ECO-BLOX RESERVOIRS

Upon start-up, the pump draws water from the reservoir to fill the streambed, from top to bottom, until the water overflows back into the reservoir to complete the cycle. The amount of water needed to complete this cycle the "transitional" water volume. If the reservoir is too small, or the streambed built improperly, the water level in the reservoir can drop below the top of the pump before cycling, leading to pump overheating and damage. Calculate the transitional water volume, then design the reservoir to hold at least three times as much, so the water level in the reservoir never drops by more than one-third when the pump is turned on, keeping the pump safely submerged at all times.

Assuming that it will take about 3" or 0.25 ft. of water to fill the stream and get the system recirculating, we can calculate the transitional volume, minimum reservoir volume and Eco-Blox quantity by using the formulas below:

$$\text{Avg. Depth (.25ft)} \times \text{Avg. Length (_____ ft)} \times \text{Avg. Width (_____ ft)} = \text{Transitional Volume}$$

$$\text{Transitional Volume} \times 3 = \text{Minimum Reservoir Volume}$$

$$\text{Minimum Reservoir Volume} \div 4.2 = \text{Number of Eco-Blox to fill Reservoir}$$

WATER DEPTH CONVERSIONS

| | | | | | |
|-----------------|-----------------|-----------------|-----------------|-----------------|-----------------|
| 1" deep = 0.08' | 2" deep = 0.16' | 3" deep = 0.25' | 4" deep = 0.33' | 5" deep = 0.42' | 6" deep = 0.50' |
|-----------------|-----------------|-----------------|-----------------|-----------------|-----------------|

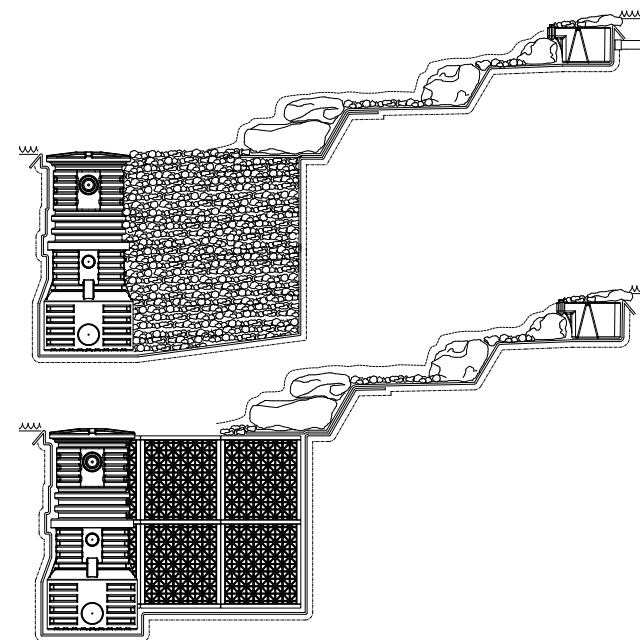

GRAVEL-FILLED RESERVOIRS

Because Eco-Blox are 96% void space, they allow the reservoir to be dug to just the size required for the water volume needed. Backfilling with gravel fills 65% of the reservoir with stone, leaving only the 35% that remains between the stones available for water storage. This means that a gravel-filled basin will need to be three times larger than an Eco-Blox basin to hold the same volume of water. That's a lot more time, excavation, additional soil removed, additional gravel to fill the hole, labor costs and cleanup.

$$\text{Transitional Volume} \times 9 = \text{Minimum Reservoir Volume (when filled with gravel)}$$

FOR LARGER BASIN VOLUMES

For installations where a larger basin volume or a deeper basin is required, Atlantic offers Pump Vault Extensions for both the PV1800 and PV2300. Each additional layer of Eco-Blox increases the depth of your excavation by 17.5"; use one Extension for each additional layer.

ROCK & GRAVEL CALCULATIONS

QUANTITY OF BOULDERS AND GRAVEL FOR A STREAM:

Tons of Boulders = 1.5 tons for every 10' of stream
Tons of Gravel = Tons of Boulders ÷ 4

RATIO OF SIZES OF BOULDERS:

For every 1 ton of 6" - 12" boulders, get 2 tons of 12" - 18" boulders, 1 ton of 18" - 24" boulders

ECO-BLOX / PUMP VAULT LAYOUTS

| | | | |
|---|---|--|--|
| <p>1 LAYER ≈ 100 GALLONS 2 LAYERS ≈ 200 GALLONS</p> | <p>1 LAYER ≈ 175 GALLONS 2 LAYERS ≈ 350 GALLONS</p> | <p>1 LAYER ≈ 275 GALLONS 2 LAYERS ≈ 550 GALLONS 3 LAYERS ≈ 825 GALLONS</p> | <p>1 LAYER ≈ 500 GALLONS 2 LAYERS ≈ 1000 GALLONS 3 LAYERS ≈ 1500 GALLONS 4 LAYERS ≈ 2000 GALLONS</p> |
|---|---|--|--|

TECHNICAL DATA

STREAM BED CONSTRUCTION

The less the water level drops as the feature turns on and the stream fills, the better for proper function. Proper streambed construction can reduce the amount of water needed for this transition.

Since transitional volume is determined by the height that the weir rock extends above the liner at the spillways, minimizing that height reduces the amount of water necessary to fill the streambed. The drawings to the right display two examples of proper construction techniques for minimal transitional water.

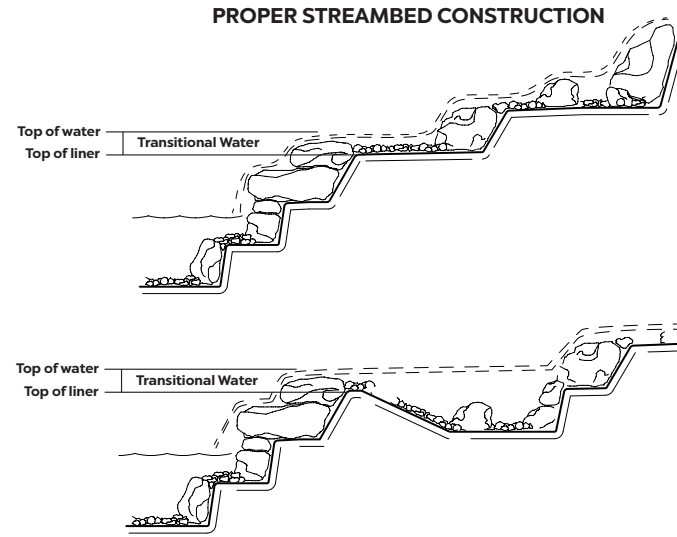
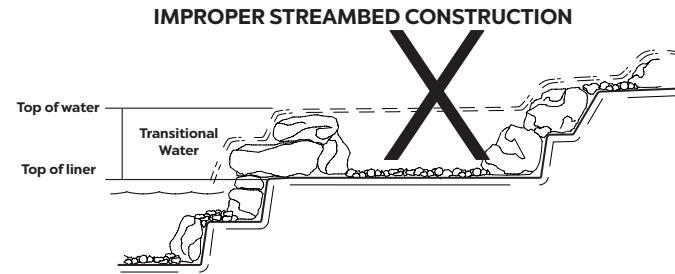

WG WATER GARDEN

Upon start-up, the pump draws water from the pond to fill the streambed, from top to bottom, until the water overflows back into the pond to complete the cycle. We call the amount of water needed to complete this cycle the 'transitional' water volume. If the streambed is built improperly, or is built too big, the water level of the pond could drop below the opening in the skimmer before the water levels equalize. This would result in the pump starving for water and running dry.

This situation can be easily avoided by using the formula provided to calculate the surface area of your pond. With that number, you can then determine the maximum surface area of waterfalls and streambed that your pond can accommodate.

To limit the transitional volume of water needed get the system cycling, the stream surface area should be half of the pond surface area or less. Follow guidelines for proper Streambed Construction.

SURFACE AREA

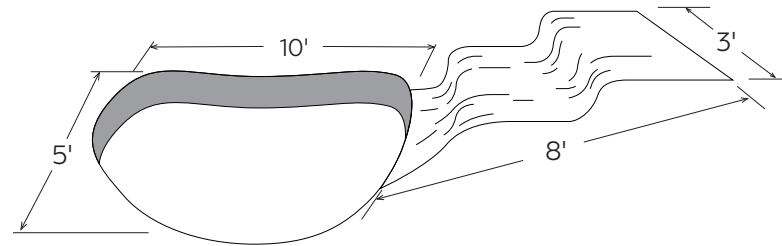

MAXIMUM AREA OF STREAM (IF YOU KNOW YOUR POND SIZE)
Average Length of Pond x Average Width of Pond ÷ 2 = Maximum Area of Stream

MINIMUM AREA OF POND (IF YOU KNOW YOUR STREAM SIZE)
Average Length of Stream x Average Width of Stream x 2 = Minimum Area of Pond

SIZING & CALCULATIONS

SIZING LINER (LENGTH, WIDTH AND DEPTH MEASURED IN FEET):
Pond Liner Length = Max. Length of Excavation + (2 x Maximum Depth) + 2'
Pond Liner Width = Max. Width of Excavation + (2 x Maximum Depth) + 2'
Stream Liner Length = Max. Length of Stream + 4'
Stream Liner Width = Max. Width of Stream + 4'

APPROXIMATE VOLUME OF WATER IN POND IN GALLONS:
Average Length x Average Width x Average Depth x 7.5
= Total Gallons in Pond

APPROXIMATE GALLONS OF WATER IN A STREAM:
Average Length x Average Width x Average Depth x 7.5
= Total Gallons in Stream

QUANTITY OF BOULDERS AND GRAVEL NEEDED FOR A FULLY ROCKED AND GRAVELED POND:
Tons of Boulders = Length x Width ÷ 40
Tons of Gravel = Tons of Boulders ÷ 4

QUANTITY OF BOULDERS AND GRAVEL FOR A STREAM:
Tons of Boulders = 1.5 tons for every 10" of stream
Tons of Gravel = Tons of Boulders ÷ 4

RATIO OF SIZES OF BOULDERS:
For every 1 ton of 6" - 12" boulders, get 2 tons of 12" - 18" boulders, 1 ton of 18" - 24" boulders

TECHNICAL DATA

PLACEMENT OF THE FILTERFALLS AND SKIMMER:

Now that you have determined the size of the pond, waterfalls and filter system, it is time to determine the placement of the components.

Whenever possible, it is best to position the Skimmer and FilterFalls directly across from each other at opposite ends of the pond. This setup creates a current that pulls surface debris into the Skimmer.

If the Skimmer and FilterFalls are placed too close together, or the pond has an unusual shape, dead areas can occur. These dead areas can be eliminated with the use of multiple falls or multiple skimmers.

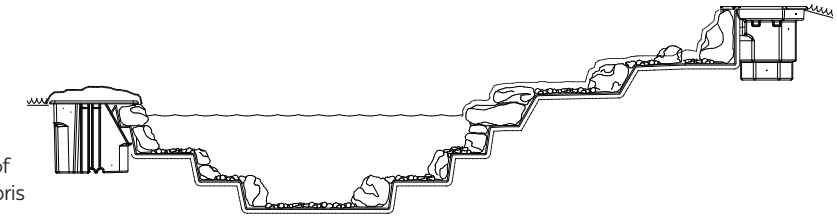

BOG CONSTRUCTION

Atlantic's Eco-Blox and Pump Vaults make excellent, easy to maintain bog filters. The Pump Vaults act as distribution nodes and cleanouts. The Eco-Blox act as settling chambers and support the weight of a thin layer of gravel, eliminating the need for massive gravel bed deposits that cannot be cleaned. For maximum versatility, install a drain in the Eco-Blox chamber so cleanouts can be reduced to simply opening and closing the drain.

DOWNFLOW BOGS:

Downflow bogs draw water in from the top to a collection point at the bottom of a deep gravel bed. They are set inside the pond, typically in deeper water than upflow bogs. They typically utilize deep gravel beds 2-4' deep that effectively trap debris for an extended period of time. Because they trap debris deep in the gravel layer underwater, they are less easily cleaned and maintained. A typical downflow bog will not need to be cleaned for 3-5 years, at which point channeling reduces its effective filtration capacity. Cleanout procedure involves removing and replacing entire gravel bed.

UPFLOW BOGS

Upflow bogs pump water in from the bottom that flows out through the top of the bog back into the pond. They are typically set at the perimeter of the pond, at or above pond level. Because the debris ends up at the surface, easily accessible, upflow bogs are easy to keep clean. When used with Eco-Blox, upflow bogs can be very effective at removing suspended solids, ammonia, nitrites and nitrates with minimal gravel thickness. Pond water pumped into the perforated pipe flows up through the Eco-Blox, shedding velocity and settling out sediment. Bacteria in the gravel on top of the Eco-Blox convert ammonia and nitrites from fish waste to nitrates. The root systems of plants in the gravel bed remove fine solids and process nitrates. To clean and maintain, install a drain in the Eco-Blox chamber that will allow settled wastes to be simply flushed out periodically.

SIZING UPFLOW BOGS:

- For water gardens with few fish and no food added, size the bog at **10%** of the surface area of the water garden
- For fish ponds with goldfish that are fed occasionally, size the bog at **20%** of the surface area of the fish pond
- For koi ponds with koi that are fed frequently, size the bog at **30%** of the surface area of the koi pond

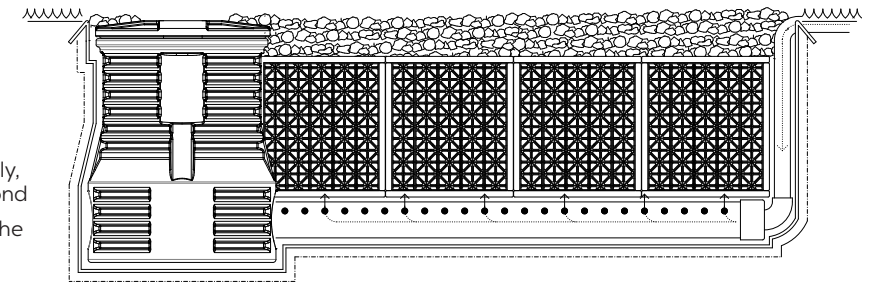

PLANT RECOMMENDATIONS:

| POND SIZE | MARGINALS | WATER LILIES | FLOATERS | SUBMERGED | BOG |
|----------------|-----------|--------------|----------|-----------|-----|
| 6' x 8' | 6 | 1 | 3 | 8 | 8 |
| 8' x 11' | 9 | 1 | 5 | 15 | 15 |
| 11' x 16' | 12 | 2 | 7 | 20 | 20 |
| 16' x 21' | 15 | 3 | 15 | 30 | 30 |
| 21' x 26' | 21 | 5 | 25 | 50 | 50 |
| Stream per 10' | 3 - 6 | --- | --- | --- | --- |

TECHNICAL DATA



PUMP

CALCULATING TOTAL DYNAMIC HEAD

1. PICK A LOOK & SPECIFY A FLOW:



Choose the appearance you would like for your waterfall from the suggested choices to the left. Multiply the corresponding **GPH Per Foot** by the desired **Width of the Waterfall** to find the **Recommended Flow**.

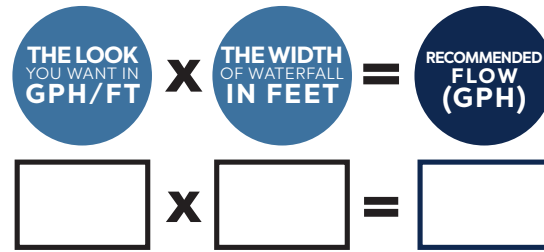

CHART A
FRICTION LOSS PER FOOT OF TUBING

| FLOW (GPH) | TUBING SIZE | | | | | | |
|------------|-------------|------|------|--------|--------|------|------|
| | 1/2" | 3/4" | 1" | 1 1/4" | 1 1/2" | 2" | 3" |
| 100 | 0.10 | 0.01 | | | | | |
| 200 | 0.38 | 0.05 | 0.01 | | | | |
| 300 | 0.83 | 0.10 | 0.02 | | | | |
| 400 | 1.00 | 0.18 | 0.04 | 0.01 | | | |
| 500 | 2.23 | 0.27 | 0.06 | 0.02 | | | |
| 750 | | 0.50 | 0.14 | 0.04 | 0.02 | | |
| 1000 | | 0.84 | 0.21 | 0.07 | 0.03 | | |
| 1250 | | 1.20 | 0.33 | 0.10 | 0.04 | 0.01 | |
| 1500 | | | 0.43 | 0.15 | 0.06 | 0.02 | |
| 2000 | | | 0.94 | 0.26 | 0.10 | 0.03 | |
| 3000 | | | 2.07 | 0.52 | 0.22 | 0.05 | |
| 4000 | | | | 1.10 | 0.43 | 0.09 | 0.01 |
| 5000 | | | | 1.80 | 0.67 | 0.15 | 0.02 |
| 6000 | | | | | 0.96 | 0.22 | 0.03 |
| 8000 | | | | | 1.77 | 0.38 | 0.05 |
| 10,000 | | | | | | 0.59 | 0.07 |
| 12,000 | | | | | | 0.84 | 0.10 |
| 15,000 | | | | | | | 0.15 |
| 18,000 | | | | | | | 0.25 |

Example: GPH: 3000 Friction Loss: 0.05 Tubing: 2"

** For flows over 10,000 GPH or lengths over 100 ft. please contact us.

CHART B
FRICTION IN EQUIVALENT FEET OF STRAIGHT PIPE

| PVC FITTINGS | FITTING SIZE | | | | | | |
|-----------------------|--------------|------|--------|--------|------|------|--|
| | 3/4" | 1" | 1 1/4" | 1 1/2" | 2" | 3" | |
| Std Elbow, 90 degree | 4.5 | 5.5 | 7.0 | 7.5 | 8.5 | 11.0 | |
| Std Elbow, 45 degree | 1.0 | 1.5 | 2.0 | 2.5 | 3.0 | 4.0 | |
| Male / Female Adapter | 1.5 | 2.0 | 3.0 | 3.5 | 4.5 | 6.5 | |
| Tee (Straight Thru) | 2.5 | 3.0 | 5.0 | 6.0 | 8.0 | 12.0 | |
| Tee (Thru Branch) | 5.5 | 7.0 | 9.0 | 10.0 | 12.0 | 17.0 | |
| Swing Check Valve | 9.0 | 11.0 | 13.0 | 15.0 | 19.0 | 27.0 | |

Example: 8.5 (90°) + 4.5 (M/FA) + 19.0 (Check Valve) = 32 (Fitting Length in Feet)

3. FIND THE TOTAL DYNAMIC HEAD

Add the Friction Head in Feet to the Vertical Head to find TDH. Vertical Head is the height in feet from the surface of the water the pump will be sitting in, to the highest point the water is pumped to.

4. CHOOSE YOUR PUMP

Locate the column representing the **Total Dynamic Head (TDH)** on the pump chart (opposite page). Find the pump that provides the required flow at that TDH. If the chart gives you a choice of more than one pump, check for the type that best fits your application, then check for the lowest wattage, to save on operating costs.

2. DETERMINE FRICTION LOSS:

2.1 FIND TUBING SIZE & FRICTION

Find the dark blue cell in the row that corresponds with the **Recommended Flow (GPH)** in CHART A. The column indicates the recommended tubing size and the number in the cell is the **Friction Loss** in every foot of tubing. Keep Friction Loss low for greatest flow.

To find the Friction Loss of existing systems, estimate the flow through the actual tubing size used.

2.2 ADD FRICTION IN FITTINGS

Add the equivalent lengths of all the fittings in the system, from CHART B, to the tubing length from pump to falls to find the **Equivalent Tubing Length**.

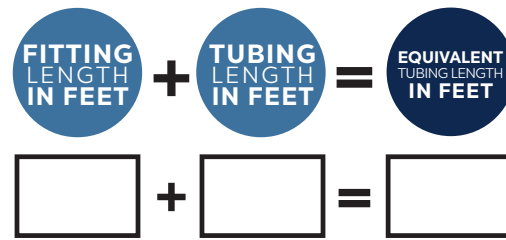

2.3 CALCULATE FRICTION HEAD

Multiply the **Equivalent Tubing Length** in feet by the **Friction Loss** in the dark blue cell from CHART A to find the **Friction Head** of the system.

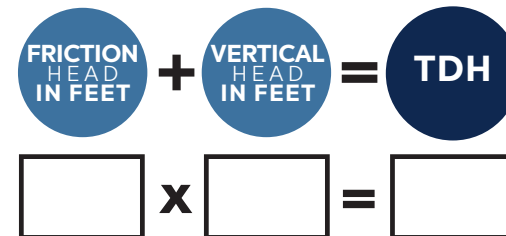
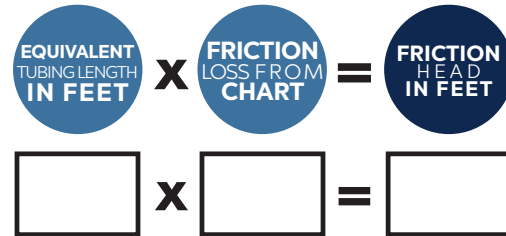

TECHNICAL DATA

| MODEL | WATTS | MAX FLOW | TDH (FEET) | | | | | | | | | | | | | | | | | | | |
|----------------------------|-------|----------|------------|-------|------|------|------|------|------|------|------|------|------|------|------|--|--|--|--|--|--|--|
| | | | 5' | 10' | 15' | 20' | 25' | 30' | 35' | 40' | 45' | 50' | 55' | 60' | | | | | | | | |
| MD-SERIES | | | | | | | | | | | | | | | | | | | | | | |
| MD250 | 15 | 300 | 65 | | | | | | | | | | | | | | | | | | | |
| MD350 | 25 | 370 | 145 | | | | | | | | | | | | | | | | | | | |
| MD550 | 40 | 650 | 385 | | | | | | | | | | | | | | | | | | | |
| MD750 | 50 | 790 | 465 | | | | | | | | | | | | | | | | | | | |
| MD1000 | 90 | 1080 | 785 | 275 | | | | | | | | | | | | | | | | | | |
| MD1250 | 120 | 1330 | 1040 | 580 | | | | | | | | | | | | | | | | | | |
| MD1500 | 165 | 1560 | 1255 | 780 | | | | | | | | | | | | | | | | | | |
| WATERFALL | | | | | | | | | | | | | | | | | | | | | | |
| 45421 | 70 | 1650 | 1350 | 800 | | | | | | | | | | | | | | | | | | |
| 45422 | 130 | 2300 | 1900 | 1420 | 700 | | | | | | | | | | | | | | | | | |
| 45423 | 170 | 3700 | 2650 | 2100 | 1200 | | | | | | | | | | | | | | | | | |
| 45424 | 230 | 5150 | 4200 | 3300 | 2280 | 700 | | | | | | | | | | | | | | | | |
| AQUAMAX ECO CLASSIC | | | | | | | | | | | | | | | | | | | | | | |
| 40437 | 45 | 1200 | 1000 | | | | | | | | | | | | | | | | | | | |
| 57620 | 70 | 1900 | 960 | | | | | | | | | | | | | | | | | | | |
| 57621 | 110 | 2700 | 1700 | | | | | | | | | | | | | | | | | | | |
| 57623 | 150 | 3600 | 2400 | 1100 | | | | | | | | | | | | | | | | | | |
| AQUAMAX ECO PREMIUM | | | | | | | | | | | | | | | | | | | | | | |
| 57499 | 65 | 2000 | 1320 | | | | | | | | | | | | | | | | | | | |
| 57500 | 110 | 3000 | 1750 | 250 | | | | | | | | | | | | | | | | | | |
| 57501 | 150 | 4000 | 2820 | 1330 | | | | | | | | | | | | | | | | | | |
| TT-SERIES | | | | | | | | | | | | | | | | | | | | | | |
| TT1500 | 101 | 1640 | 1060 | 350 | | | | | | | | | | | | | | | | | | |
| TT2000 | 115 | 2640 | 1760 | 715 | | | | | | | | | | | | | | | | | | |
| TT3000 | 173 | 3000 | 2180 | 1215 | 475 | | | | | | | | | | | | | | | | | |
| TT4000 | 230 | 4490 | 3330 | 1785 | 700 | | | | | | | | | | | | | | | | | |
| TT5000 | 310 | 5150 | 4255 | 3170 | 1615 | | | | | | | | | | | | | | | | | |
| TT6000 | 334 | 6600 | 4915 | 3395 | 1750 | | | | | | | | | | | | | | | | | |
| TT7500 | 520 | 7650 | 6300 | 4640 | 2860 | 1250 | | | | | | | | | | | | | | | | |
| TT9000 | 587 | 8800 | 7470 | 5990 | 4260 | 2595 | | | | | | | | | | | | | | | | |
| ECO EXPERT AQUARIUS | | | | | | | | | | | | | | | | | | | | | | |
| 57875 | 440 | 7300 | 6100 | 5000 | 4300 | 3250 | 1400 | | | | | | | | | | | | | | | |
| 57963 | 700 | 11500 | 10000 | 8400 | 6850 | 5350 | 3900 | 1970 | | | | | | | | | | | | | | |
| AQUAMAX AQUARIUS | | | | | | | | | | | | | | | | | | | | | | |
| 57964 | 440 | 6800 | 6700 | 5825 | 4800 | 3900 | 2825 | 1150 | | | | | | | | | | | | | | |
| 57978 | 700 | 11500 | 10300 | 8700 | 7310 | 5560 | 3800 | 2100 | | | | | | | | | | | | | | |
| SH-SERIES | | | | | | | | | | | | | | | | | | | | | | |
| SH1450 | 240 | --- | 1170 | 650 | | | | | | | | | | | | | | | | | | |
| SH2050 | 320 | --- | 1700 | 1130 | | | | | | | | | | | | | | | | | | |
| SH3600 | 575 | --- | 3245 | 2750 | 2090 | | | | | | | | | | | | | | | | | |
| SH5000 | 950 | --- | 4350 | 3620 | 2800 | | | | | | | | | | | | | | | | | |
| SH6500 | 1000 | --- | | 4875 | 4000 | 3080 | | | | | | | | | | | | | | | | |
| PAF-SERIES | | | | | | | | | | | | | | | | | | | | | | |
| PAF-20 | 360 | --- | 2800 | 1950 | 1080 | | | | | | | | | | | | | | | | | |
| PAF-25 | 545 | --- | 3900 | 3150 | 2300 | | | | | | | | | | | | | | | | | |
| PAF-40 | 650 | --- | | 4350 | 3570 | 2700 | | | | | | | | | | | | | | | | |
| PAF-75 | 900 | --- | | | 4560 | 3750 | 2830 | | | | | | | | | | | | | | | |
| A-SERIES | | | | | | | | | | | | | | | | | | | | | | |
| A-05 | 645 | --- | | | 2500 | 2155 | 1875 | 1455 | 935 | | | | | | | | | | | | | |
| A-05L | 725 | --- | | | 4320 | 3600 | 2820 | 1920 | | | | | | | | | | | | | | |
| A-21 | 1060 | --- | | | | 4335 | 3770 | 3140 | 2400 | | | | | | | | | | | | | |
| A-31 | 1160 | --- | | | | 8150 | 6830 | 5535 | 4120 | 2535 | | | | | | | | | | | | |
| A-32 | 2055 | --- | | | | | | | | | 8280 | 7560 | 6780 | 5580 | 4920 | | | | | | | |
| L-SERIES | | | | | | | | | | | | | | | | | | | | | | |
| L-305 | 710 | 11400 | 10380 | 7380 | | | | | | | | | | | | | | | | | | |
| L-310 | 1105 | 14200 | 13500 | 10560 | 7380 | | | | | | | | | | | | | | | | | |

Recommended Operating Range Best Efficiency Range Do Not Operate Range

TECHNICAL DATA

PUMP APPLICATION GUIDELINES

- For very low head, very low volume, use Fountain Pumps (FP-Series and OASE Fountain Pumps)
- For low head, low volume, use Magnetic Drive Pumps (MD Series and OASE Waterfall Pumps)
- For low head, very high volume, use Axial Pumps (L-Series) with 3" or larger tubing
- For medium head, medium volume, use Asynchronous and Synchronous Pumps (TT-Series and OASE AquaMax Classic & Premium)
- For medium head, medium volume variable operation, use TidalWave Variable Speed Controller (TWVSC) with TT-Series Asynchronous Pumps
- For high head, high volume applications, use Direct Drive Pumps (A-Series)
- For solids and dirty water applications, use Direct Drive Solids Handling Pumps (PAF and SH-Series)
- For variable flow from low to high head and low to high volume, use DC Brushless Pumps (OASE Aquarius and AquaMax Eco Expert)

COST TO RUN A PUMP

Take the rate per kilowatt per hour, multiply that by the wattage of the pump and divide by 1000. For the monthly cost, multiply the hourly cost by 720 (24 hours per day times 30 days in a month). For more information, visit the College of Pumps in the Atlantic Water Gardens University, www.atlanticwatergardens.com/university.

$$\text{COST PER HOUR} = \text{_____ } \$ / \text{kW/hr.} \times \text{_____ Watts} \div 1000 = \text{_____} \times 720 = \text{_____ COST PER MONTH}$$

Example: Electric costs \$0.10/kW/hr, the pump draws 100 Watts, so \$0.10/kW/hr x 100W/1000 = \$0.01/hr x 720hrs/mo = \$7.20/month

GROUNDING PLATE

This added measure of protection on OASE pumps exceeds all electrical safety standards. The grounding plate provides the path of least resistance, insuring that any electrical leakage, from any power source in your pond or fountain, harmlessly exits the pond or fountain through the grounding wire. With this feature, your pond or fountain will have unparalleled protection against electrical hazards.



LIGHTING

REPLACING DIODES ASSEMBLIES

All the diode assemblies of the lights pictured can be replaced as needed. For the Hardscape Lights, remove the screws, unplug the light bar, plug in the new light bar, align the silicone gasket and retighten screws.

For the 2 and 4 watt Spotlights and the Spout Light, unscrew the bezel by hand, remove the diode assembly, replace and retighten bezel. In every case, make sure silicone gasket is properly seated to avoid leaks.

2 WATT SPOTLIGHT:

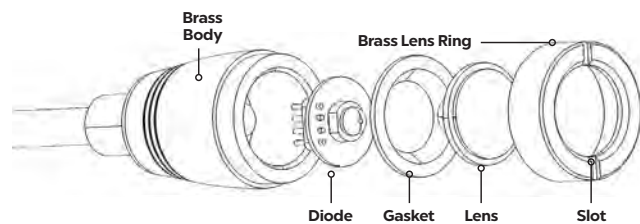

SPOUT LIGHT:

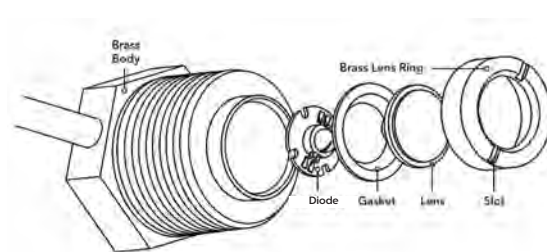

4 WATT SPOTLIGHT:

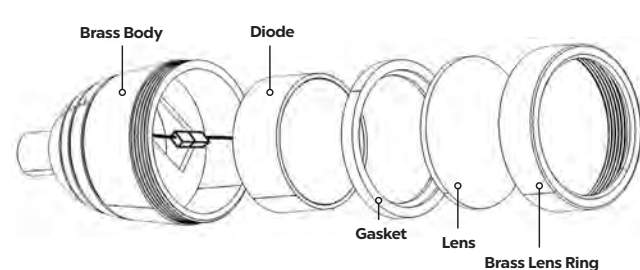

HARDSCAPE LIGHT:

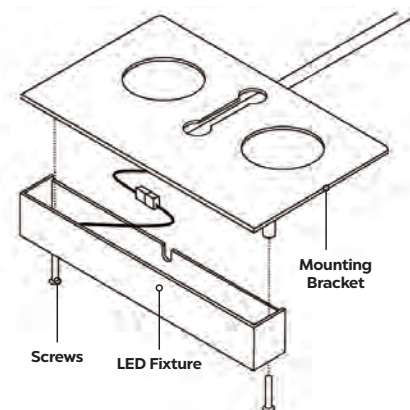

TECHNICAL DATA

MAKING CONNECTIONS

The multistrand cord for Color Changing Lighting carries both AC and DC current that cannot be interchanged, so proper alignment of plugs is a must. **Dielectric grease must be used in all connections.** Any water intrusion into the quick-connect plugs will cause short circuiting. Make sure all connecting plugs are fully tightened. To fully tighten plugs, seat the nut as tightly as possible, then flex the connection two or three times and re-tighten the nut. Repeat until you can no longer tighten the nut. This assures the o-ring is fully seated and the connection is weather-tight. As a general rule, full or partial submersion of quick-connect plugs should be avoided.

CONNECTING FIRST AND SECOND GENERATION LIGHTING

All Atlantic Color Changing Lighting is fully forward and backward compatible. The new InfiColor Smart Module includes an adapter to connect to any Color Changing light, past or present. 5-pin Color Changing lights include an adapter to connect to 6-pin Color Changing Control Modules, Lights, Extensions and Splitters.

TO USE NEW LIGHTS WITH SOL COLOR CHANGING CONTROL MODULE

Use the 5-wire to 6-wire adapter included with every 5-wire Color Changing light. Apply dielectric grease, included with all lights, to the pins. Line up the keys, insert the plug and tighten threaded ring. Complete the tightening process by flexing the connection and retightening the threaded ring as needed until firmly seated.

TO USE SOL COLOR CHANGING LIGHTS WITH INFICOLOR SMART MODULE AND APP

Use the 5-wire to 6-wire adapter included with every InfiColor Smart Module and App. Apply dielectric grease, included with Module. Line up the key, insert the plug and tighten threaded ring. Complete the tightening process by flexing the connection and retightening the threaded ring as needed until firmly sealed.

HOW TO CALCULATE WATTAGES & MAKE CUSTOM SETUPS

HOW TO CALCULATE WATTAGES & MAKE CUSTOM SETUPS

The InfiColor Smart Module provides 40 watts to each of three zones. The zones may be linked and synchronized as desired. Add up the wattage of each light, which can be found in the Catalog, the packaging, the instructions or the website, to find the total wattage of the group. The wattage shown is the highest wattage that the light will draw, rounded up to ensure Smart Module capacity is never exceeded.

There is also a limit to the length of any lighting run. The number of extension cords you can use consecutively depends on the total wattage of the zone.

If your total wattage is:

- 0-10 watts - 4 extension cords max
- 10-20 watts - 3 extension cords max
- 20-30 watts - 2 extension cords max
- 30-40 watts - 1 extension cord max

INFICOLOR MOBILE APP

To Configure Zone Names and Timers

Click dropdown menu. Edit the names of the control module outlets or zones on the "Zone Settings" page. These zone names will be visible throughout the app. Each zone has an individual timer function to turn the zone on and off at set times. Click the "Save" button to save changes. A box will come up notifying the user the settings have been saved. Click the "Back" button once you have completed configuration. See the "Customization Info" tab in the drop down menu in the app for on-screen instructions.

Color Tab

Use the Color tab to choose colors for the different zones using either the color picker or the red, green and blue sliders at the bottom. Choose the brightness of the color by adjusting the slider. Select the color for each zone, or select multiple zones to change color at the same time.

Favorites Tab

The Favorites tab stores preset color changing sequences. Select one, two or all three zones. Choose a sequence of colors, then choose the transition between them, the speed of the sequence and the brightness. The Edit button deletes stored Favorites you have created.

Custom tab

The Custom tab allows you to create and store a custom color changing sequence. Move the red, green and blue sliders to choose a color, or select it from the color picker. Once you have decided on the color, click the "Plus" button to add it to the sequence. Repeat as desired. Add up to 10 colors to a sequence. Once the sequence has been created it can be named and saved. The saved sequence will be available on the Favorites page.

USING THE CORD SEAL FITTINGS TO PASS A LIGHT CORD THROUGH THE WATER SUPPLY LINE

There may be times when the only way to run a light cord into a reservoir is to pass the cord inside the water supply plumbing. Atlantic's Cord Sealing Fittings do just that, simply and easily. First, determine how to attach two Tee fittings to the supply plumbing, one on either side of the pass-through fitting that goes through the reservoir wall. Usually a Sch. 40 PVC 1/2" Tee is the preferred size, because the cord will not affect water flow in that large a supply line. Once the Tees are in place, pass the light cord through the Tees. Open the Cord Seal Fittings and insert the cord into each one, then tighten the fittings into the open legs of the Tees, snugging the cord between the fittings before fully tightening. Turn on water supply and check for leaks.

TECHNICAL DATA



MAINTENANCE

SMALL POND AERATION:

Aeration is critical for water clarity and quality, summer and winter.

In warm weather, aeration circulates and oxygenates water to the bottom, allowing for fast aerobic decomposition of wastes and eliminating hot spots at the surface where algae thrives.

In cold weather, move the aerator to the shallows to keep a section of the surface free of ice economically, allowing replenishment of oxygen and the degassing of carbon dioxide, without disturbing the pocket of warm water at the bottom of the pond.

SUMMER DIFFUSER PLACEMENT:

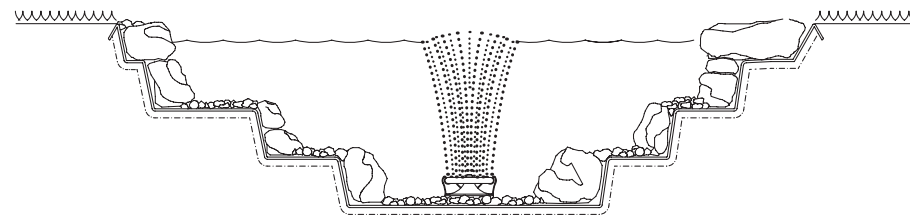

WINTER DIFFUSER PLACEMENT:

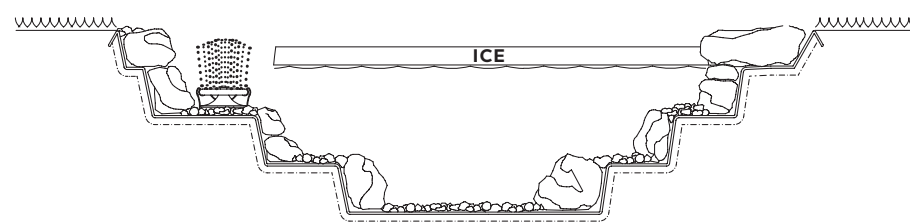

REPLACING DIAPHRAGMS IN AIR PUMPS

Rubber diaphragms are a wearable part that will need servicing over time. Moisture, heat and dust will all shorten the life of the diaphragms. Please follow the following steps when installing replacement diaphragms.

TA0400 & TA0800

- Remove the four screws on the bottom of air pump housing.
- Remove the top cover taking care not to damage/misplace the outer gasket and four O-rings that seal the housing at the screw connections.
- Remove the three screws and the bracket that hold the diaphragm cartridge in place.
- Unplug the outlet hose and remove the diaphragm cartridge.
- Discard and install the new cartridge.

TA1800 & TA3600

- Remove the top cover housing for the air pump. Loosen the air chamber screws (1) and remove the outer air chamber (2).
- Loosen the diaphragm nut (3) and remove the diaphragm depressor (4), electrostatic membrane (5) and the damaged diaphragm (6).
- Install the new diaphragm ensuring that the rubber tabs align properly with the notches on the inner air chamber.
- Once the diaphragm is seated properly, assemble the components by following the previous steps in reverse order.

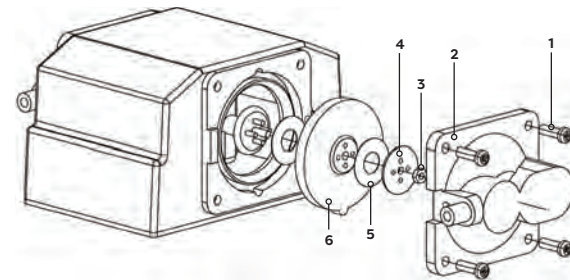
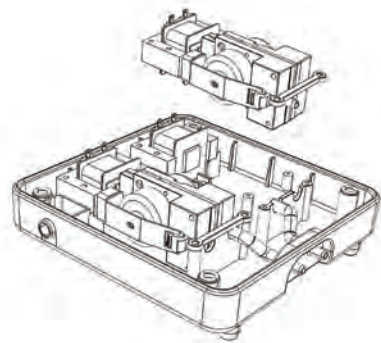

WATER TREATMENT GUIDE

| CONDITION: | REVIVE | BIOMAX+ | QUICKCLEAR | ECOSOLV | ECOKLEAN | CLARITYBLAST | RECLAIM | BIOMAX |
|----------------------|--------|---------|------------|---------|----------|--------------|---------|--------|
| NEW WATER GARDEN | • | • | | | | | | |
| WATER CHANGE | • | • | | | | | | |
| ADDING FISH | • | • | | | | | | |
| ELEVATED AMMONIA | • | • | | | | | | |
| MUDDY / CLOUDY WATER | | | • | | | | | |
| SUSPENDED ORGANICS | | • | • | • | | • | | • |
| ATTACHED ORGANICS | | | | • | • | • | • | |
| SLUDGE | | | | | | • | • | |
| PLANT DEBRIS | | | | | • | • | • | • |
| FOUL ODOR | | | | | | • | • | • |

TECHNICAL DATA



POND & LAKE

Aeration and bacterial treatments are the best way to maintain ponds and lakes clear, clean and sediment free when properly sized and dosed. The three keys to sizing aeration are Depth, Shape and Profile.

DEPTH

Circulation is directly proportional to depth. The deeper the water, the longer the path to the surface for the rising bubbles and the more water each bubble can pull upwards with it. The rising water has to be replaced by water sweeping in towards the diffuser, so a relatively small amount of air rising from deep water can circulate a tremendous volume. Shallow water doesn't provide as much 'fetch', or time for the bubbles to act on the water column, so circulation is reduced and more air needed per given area. The water welling up from a deeply set diffuser has a great deal of inertia, which causes it to flow outward in all directions once it reaches the surface. The diameter of the circle of aerated water created is proportional to the depth. The same diffuser set in shallow water will aerate a smaller area.

Figure 1.

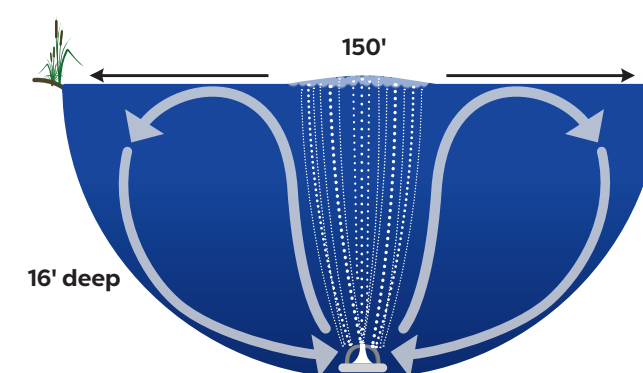

Deep Water Aeration System with 1 Deep Water Diffuser - TPD100S

Figure 2.

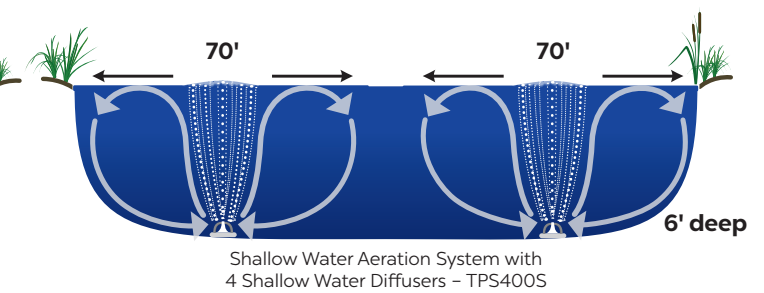

Shallow Water Aeration System with 4 Shallow Water Diffusers - TPS400S

SHAPE

The shape of the water feature also affects circulation. A simple circle can typically be circulated with just one diffuser, while more complex shapes with coves and peninsulas that impede flow will require more diffusers, and more air. All four lakes below have the same area, but their different layouts require a different number of diffusers.

Figure 3.

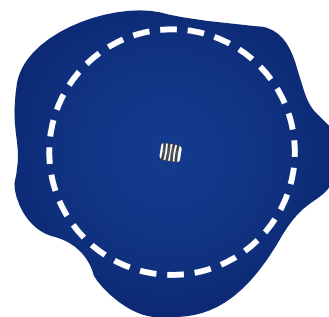

Figure 4.

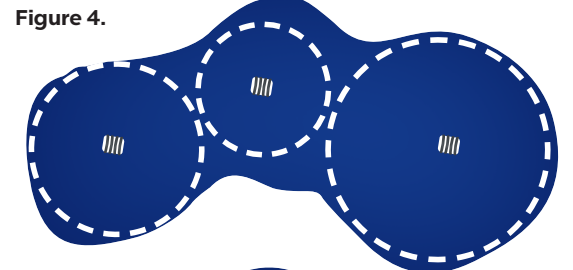

Figure 5.

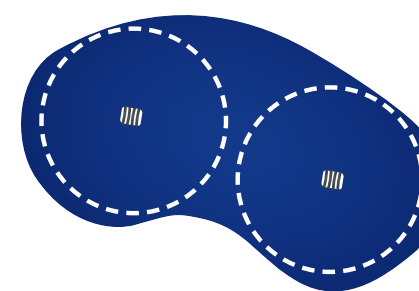
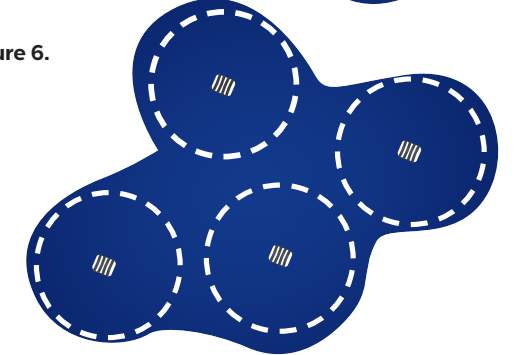

Figure 6.



PROFILE

The quantity and placement of diffusers depends on the inner profile of the water feature as well, which will either enhance or impede flow. Rounded profiles with steep sides and few shelves or obstructions, like the bowl-shaped pond in Figure 1, can be aerated most easily. Wide, flat bottomed features like the pond in Figure 3, or shallow lakes with debris and vegetation everywhere will be more difficult to aerate and circulate effectively.

TECHNICAL DATA

SIZING YOUR SYSTEM: USE SURFACE AREA FOR LAKES WITH SIMPLE SHAPES AND SINGLE DEPTHS

Step 1. If your pond is roughly rectangular, square or circular, find the area of the pond and convert the square footage to acres by dividing by 43,560. (1 acre = 43,560ft²)

Step 2. Find the Acreage and Depth of your pond on the Chart to determine the correct system or number of systems.

EXAMPLE:
For the roughly square pond at the right, 150 feet on a side:
Multiply 150' x 150' to find the area and divide by 43,560 to convert to surface acres.

$$\frac{150'}{150'} \times 150' = 22,500 \text{ ft}^2$$

$$\frac{22,500 \text{ ft}^2}{43,560 \text{ ft}^2/\text{acre}} = .52, \text{ about } \frac{1}{2} \text{ surface acres}$$

Find the column corresponding to 16' and locate the matching surface area. In this case the correct system is a TPD100S-87R6. In the case of lakes larger than the surface areas listed, multiple systems will be required.

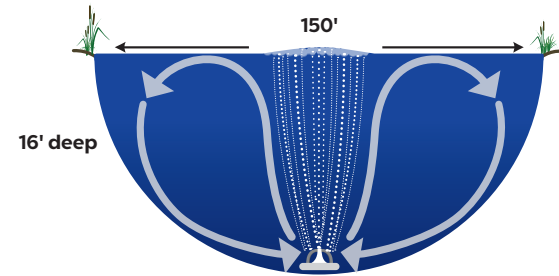

| SYSTEM | No. of Diffusers | Coverage @2' | Coverage @4' | Coverage @6' | Coverage @8' | Coverage @12' | Coverage @16' | Coverage @20' |
|--------------|------------------|--------------|--------------|--------------|--------------|---------------|---------------|---------------|
| TPS200S | 2 | 1/8 acre | 1/4 acre | 1/2 acre | --- | --- | --- | --- |
| TPS400S | 4 | 1/4 acre | 1/2 acre | 1 acre | --- | --- | --- | --- |
| TPD100S-87R6 | 1 | --- | --- | --- | 1/4 acre | 1/2 acre | 1 acre | 2 acres |
| TPD200S-87R6 | 2 | --- | --- | --- | 1/2 acre | 1 acre | 2 acres | 4 acres |
| TPD300S-72R6 | 3 | --- | --- | --- | 3/4 acre | 1 1/2 acres | 2 1/2 acres | 4 acres |
| TPD400S-72R6 | 4 | --- | --- | --- | 1 acre | 1 1/2 acres | 2 acres | 4 acres |

SIZING YOUR SYSTEM: USE DIAMETERS FOR LAKES WITH COMPLEX SHAPES AND MULTIPLE DEPTHS

Step 1. Draw the perimeter roughly to scale or download a satellite image.

Step 2. Determine the depth(s) and find the corresponding size circle from the tables below.

Step 3. Draw circles to scale, covering the surface without overlapping. Each circle equals one diffuser.

Step 4. Find the appropriate shallow or deep water system(s) with the correct number of diffusers.

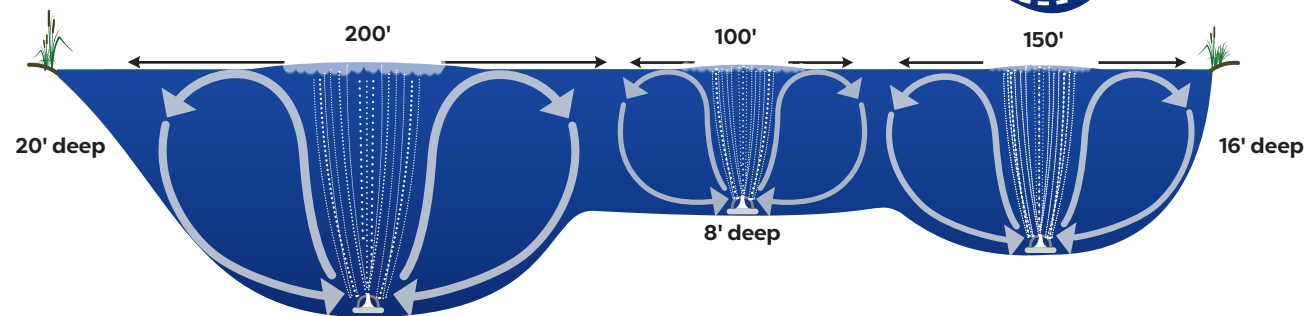
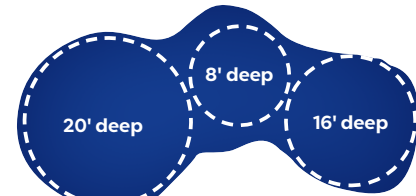

EXAMPLE:
The lake above is 200' wide and 20' deep at one end, 150' wide and 16' at the other, with a shallower 8' deep section 100' wide in the middle. From the depths on the chart below, draw the three circles to scale on your sketch. In this example, three circles are sufficient, so you will need a deep water system with three diffusers. The second column of the chart above indicates the required system with three deep water diffusers is the TPD300S-72R6. In the case of larger lakes requiring more than four diffusers, use multiple systems to cover the entire surface area.

| AREA COVERED BY SHALLOW WATER DIFFUSER | | | |
|--|-----|-----|-----|
| DEPTH | @2' | @4' | @6' |
| Circle Diameter | 40' | 55' | 70' |
| Diffusers per Surface Acre | 16 | 12 | 8 |

| AREA COVERED BY DEEP WATER DIFFUSER | | | | |
|-------------------------------------|------|------|------|------|
| DEPTH | @8' | @12' | @16' | @20' |
| Circle Diameter | 100' | 120' | 150' | 200' |
| Diffusers per Surface Acre | 4 | 3 | 2 | 1 |

TECHNICAL DATA

CLEAR WATER GUARANTEE



OASE has engineered specific filter systems to provide the OASE Clear Water Guarantee (CWG). Using a CWG filter system we guarantee you will be able to read the 1" marking on a tape measure when the tip is submerged to a depth of 3'.

A filter system consists of:

- A pump to feed the water into a filter
- A filter that ensures biological and mechanical cleaning
- A UVC clarifier to clean the green out of the water

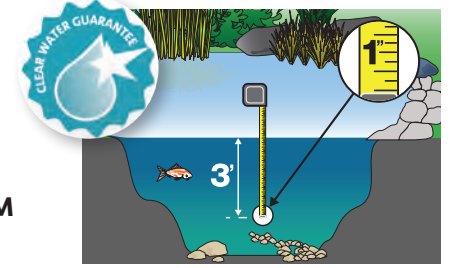

CLEAR WATER GUARANTEE PROGRAM

1. Determine your pond volume:

For circular ponds: Pond volume (gallons) = diameter (ft.) x diameter (ft.) x depth (ft.) x 5.9
For rectangular ponds: Pond volume (gallons) = length (ft.) x width (ft.) x depth (ft.) x 7.5

2. Determine the fish load: The more fish in the pond, the higher the nutrient load and the larger the filter system should be.

- LIGHT** - Planted ponds with few or no fish
- MEDIUM** - Planted ponds with 10 in. of fish per 100 gallons of water or less
- HEAVY** - Planted ponds with koi or 20+ in. of fish per 100 gallons of water

3. Choose the correct filter system: Use the filter system chart to determine the appropriate filter system for your pond.

4. Install and maintain the filter system: Install the CWG products as per the installation instructions. Clean the filter as needed and replace the UVC bulb annually.

FILTER SYSTEMS - SIZING CHARTS

IN-POND FILTER SYSTEMS - for small ponds. In-pond filters include 3 nozzle choices for appeal and added aeration.

| FISH LOAD | | | IN-POND FILTER | UVC | PUMP |
|-----------|----------|-------|------------------|-------------|------------------|
| LIGHT | MEDIUM | HEAVY | | | |
| <700 gal | <350 gal | - | Filtral UVC 700 | 7W included | 250 gph included |
| <1200 gal | <600 gal | - | Filtral UVC 1200 | 9W included | 580 gph included |

PRESSURE FILTER SYSTEMS - for small to medium ponds. Pressure filters can be remotely located, partially buried and feed waterfalls.

| FISH LOAD | | | PRESSURE FILTER | UVC | PUMP |
|-----------|-----------|-----------|-----------------|--------------|---|
| LIGHT | MEDIUM | HEAVY | | | |
| <1000 gal | <500 gal | <250 gal | BioPress 1000 | 7W included | AquaMax Eco Classic 1200 |
| <1600 gal | <800 gal | <400 gal | BioPress 1600 | 9W included | AquaMax Eco Premium 2000 / AquaMax Eco Classic 1900 |
| <2400 gal | <1200 gal | <600 gal | BioPress 2400 | 9W included | AquaMax Eco Premium 3000 / AquaMax Eco Classic 2700 |
| <3000 gal | <1500 gal | <750 gal | FiltoClear 3000 | 18W included | AquaMax Eco Premium 2000 / AquaMax Eco Classic 1900 |
| <4000 gal | <2000 gal | <1000 gal | FiltoClear 4000 | 24W included | AquaMax Eco Premium 3000 / AquaMax Eco Classic 2700 |
| <8000 gal | <4000 gal | <2000 gal | FiltoClear 8000 | 55W included | AquaMax Eco Premium 4000 / AquaMax Eco Classic 3600 |

FLOW-THROUGH FILTER SYSTEMS - for medium to large ponds. Flow-through filters sit above water level and return water by gravity.

| FISH LOAD | | | FLOW-THROUGH FILTER | UVC | PUMP |
|------------|------------|-----------|---------------------------------------|----------------------------|---|
| LIGHT | MEDIUM | HEAVY | | | |
| <5000 gal | <5200 gal | <1250 gal | BioSmart 5000 | Vitronic 18 | AquaMax Eco Premium 2000 / AquaMax Eco Classic 1900 |
| <10000 gal | <5000 gal | <2500 gal | BioSmart 10000 | Vitronic 36 | AquaMax Eco Premium 3000 / AquaMax Eco Classic 2700 |
| <18000 gal | <9000 gal | <4500 gal | BioTec ScreenMatic ² 18000 | Bitron C 55 | AquaMax Eco Premium 4000 / AquaMax Eco Classic 3600 |
| <21000 gal | <10500 gal | <5250 gal | ProfiClear Premium Compact-M | Bitron C 55 / Bitron C 110 | AquaMax Eco Premium 4000 / AquaMax Eco Expert 6800* |
| <24000 gal | <12000 gal | <6000 gal | BioTec ScreenMatic ² 24000 | Bitron C 55 / Bitron C 110 | AquaMax Eco Premium 4000 / AquaMax Eco Classic 3600 |
| <31500 gal | <15750 gal | <7875 gal | ProfiClear Premium Compact-L | Bitron C 110 | AquaMax Eco Premium 4000 / AquaMax Eco Expert 6800* |
| <38000 gal | <19000 gal | <9500 gal | BioTec ScreenMatic ² 38000 | Bitron C 110 | AquaMax Eco Expert 6800 |

*Must adjust flow down to Max flow of filter

ATLANTIC DISTRIBUTOR CONSULTANTS & ATLANTIC PROFESSIONAL CONTRACTORS

A PARTNERSHIP TO BE PROUD OF



We welcome the opportunity to help link our Distributors with the very best Landscape Professionals in the United States – and visa-versa. We want to create a partnership between the most important people in our supply chain who, together, have one combined goal; to deliver and install the best products on the market for the homeowner.

Although this is a Distributor-driven program, we here at Atlantic-OASE can help this happen by making your business PREFERRED – whichever of these two links in the chain you represent. There are many benefits to both programs. As the facilitators of the ADC/APC program, just let us know if you sell, or install, predominantly Atlantic-OASE products.

To receive more details of these programs and the benefits associated with them, please contact our ADC/APC administration coordinator at: apcadc@atlanticwatergardens.com

IN-HOUSE TRAINING FACILITY

Interested in hands-on and classroom instruction in any facet of water feature construction? The climate-controlled Training Facility in our warehouse features 2000 square feet of walls and patios with multiple Fountain and Formal Spillway installations. Look behind the block to inspect and install valved plumbing manifolds and remote filtration options for the hardscape. Dig a pond or pond-free reservoir in the 120 cubic yard SandBox led by our in-house experts. Learn advanced lighting techniques illuminating the trees and shrubs under the 30-foot ceilings. Give us a call for the latest training schedules!



AWG UNIVERSITY

Atlantic Water Gardens University is your online home for water feature education. Start with the College of Construction then move on to Pumps, Filtration and Biology for solid, non-biased, valuable information from professionals that have years of experience in the field. When you finish each section, take the course exam to test your knowledge and earn your Atlantic Water Gardens University Certificate of Completion.



SOCIAL MEDIA

Follow us on all of our social media accounts to stay in the loop for all news Atlantic-OASE. We feature tech tips, inspirational photos, special announcements, behind-the-scenes and everything water features. Don't forget to use the @atlanticwatergardens and @oase_na to tag us in your posts.



CUSTOMER LOGIN INFO

To access our high resolution product images, please log in to our website www.atlanticwatergardens.com to access images and other downloads we have available to your company. Login link is located on the right hand side of the page "Customer Login". Please contact the marketing department for login information.

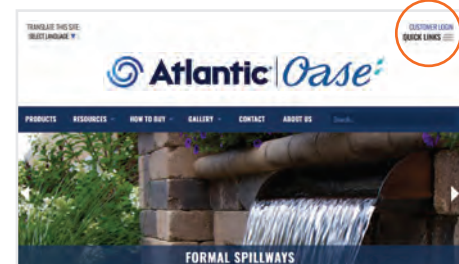

To download images, in the top right hand corner of the website, (in the bright blue bar), you'll see a link that is labeled "Download Files". There you can download full product categories, or if you are looking for individual images, you can click on the links provided and you will be taken to that category folder and be able to select individual images.

POP MATERIAL



Model: TMBF
Description: Fountains Bifold

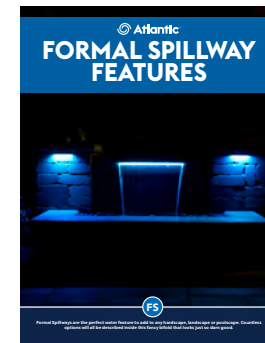

Model: TMBFS
Description: Formal Spillways Bifold

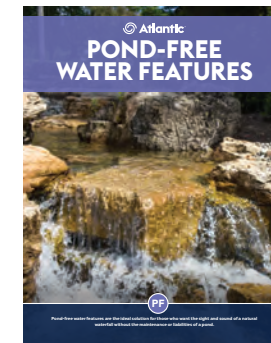

Model: TMBPF
Description: Pond-free Bifold



Model: TMBWG
Description: Water Garden Bifold



Model: TMBP
Description: Choosing the Perfect Pump Bifold



Model: TMBPL
Description: Pond & Lake Management Booklet

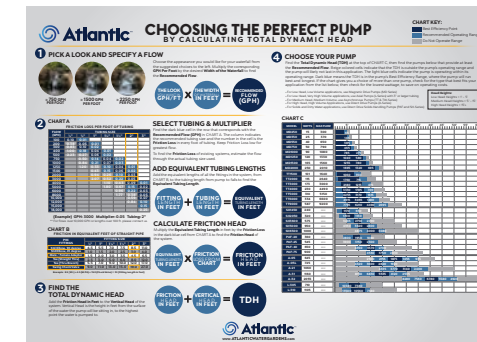

Model: TMCM
Description: Choosing the Perfect Pump Counter Mat
Dimensions: 19"W x 14"H



Model: SS DISPLAY
Description: Spillway Skeleton Display
Dimensions: 20"W x 24"D x 30"H



Model: SC DISPLAY
Description: Spillway Skeleton Display
Dimensions: 20"W x 24"D x 30"H



Model: CF DISPLAY
Description: Colorfalls Skeleton Display
Dimensions: 20"W x 24"D x 30"H



Model: WS DISPLAY
Description: Wall Spout Skeleton Display
Dimensions: 20"W x 24"D x 30"H



Model: TMATL-S
Description: Atlantic Standing Banner
Dimensions: 36"W x 83"H



Model: TMAO-W
Description: OASE Wall Banner
Dimensions: 60"W x 36"H



Model: TMATL-W
Description: Atlantic Wall Banner
Dimensions: 60"W x 36"H



 **Atlantic** | *Oase*

125 Lena Drive, Aurora, Ohio 44202

P: 1.330.274.8317 | F: 1.330.274.8790

E: info@atlanticwatergardens.com

www.ATLANTIC-OASE.com