

# RETAINING WALLS

## by Allan Block®

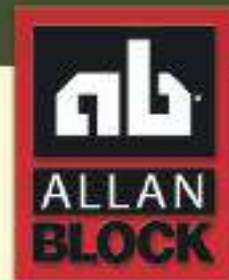

**Plan, Design and Build**  
Allan Block Residential Landscape Walls

[allanblock.com](http://allanblock.com)

A Complete  
Installation Guide



AB Fieldstone Collection  
Facing Series: Sierra  
Color: Sandstone



allanblock.com

## Table of Contents

	Page
AB Aztec Collection <b>NEW</b>	2-3
AB Fieldstone Collection <b>NEW</b>	4-5
AB Europa Collection	6-7
AB Collection	8-9
Plan the Wall	10-11
Design the Wall	12-17
Water Management	18-19
Job Site Considerations	20
Working with Soils	21
Basic Installation	22-23
Geogrid Installation	24-25
Patterned Wall Installation	26-28
AB Fieldstone Installation	29-31
Curved Walls	32-33
Corners	34-35
Curves and Corners with Geogrid	36-37
Stepping up the Base	38-39
Stairway Installation	40-43
In-Wall Planters and Terraces	44-45
Water Features	46
Lighting	47
Step Downs	48-49
Parapets and Posts with AB Fieldstone	50-53
Finishing Options	54-55
Const. & Inspection Checklist	56
Estimating Charts	57
AB Courtyard Collection	58-61

## Allan Block

Allan Block is a leading provider of patented retaining wall systems. For over twenty five years Allan Block has been bringing innovative products to the landscape community. *We can provide quality and performance to any project with our complete line of products. You can be confident you are making the right choice with any Allan Block product.*

Visit our website at [allanblock.com](http://allanblock.com) to find information about **Going Green** with Allan Block or to locate your closest AB distributor for pricing, availability, color selection and much more.



AB Europa Collection

Visit [allanblock.com](http://allanblock.com) for more information.

### Charts and Tables

AB Aztec Product Specs	2
AB Fieldstone Product Specs	4
AB Europa Collection Product Specs	6
AB Collection Product Specs	8
Maximum Wall Heights - Gravity Walls	12
Soil Reinforcement Chart (geogrid)	25
Wall Pattern Block Quantities	28
Radius Chart	33
Estimating Charts	57



**Have a tablet?  
Download our  
materials for  
iBooks.**





AB Collection

*Visit us at [allanblock.com](http://allanblock.com) to find everything you need.*

**Photo Gallery and Video Library**

Easily navigate through our vast selection of project photos for great ideas. Watch our detailed installation videos to learn the correct process for using our products.

**Estimating Tools**

Quickly determine the quantities of all materials needed for your project, ensuring your project is successful right from the start.

**Residential Retaining Wall App - NEW**



Use your smart phone or tablet to quickly estimate your retaining wall project. Receive a detailed output showing the different retaining wall collections that you can choose from for your project. Also included are cross section drawings and a complete material estimate you can bring to your local supplier.

**Product Details and Installation Guides**

With several product lines to choose from to complete your project, you will be sure to find the best option as well as complete detailed installation guides to help you along the process of planning, designing and building your project.

**Training Events**

Locate a DIY seminar or training event close to you to see a hands-on demonstration of the Allan Block products. Talk to experts to learn tips and tricks that will help with your project.

**Where to Buy**

Find a local distributor with the best services, available colors and products by entering your zip or postal code. Looking for a contractor to do the job, ask the local distributor for their list of certified and trained contractors.

**Questions**

Visit [allanblockblog.com](http://allanblockblog.com) for a great resource on the Allan Block products that includes FAQ's and helpful information.

***Additional Support***

For taller walls see our **AB Commercial Retaining Wall Manual** for walls over 6 ft. (1.8 m) high or visit our website for complete details.



Visit the Allan Block Channel



allanblock.com



AB Aztec Collection

*AB Aztec Collection™*  
*The Same Dependable Allan Block System in a*  
*Brand New Centuries Old Look*

Allan Block is always striving to be "Always Better". This can be seen with our new AB Aztec Collection. No need to learn the tricks of a new system, the AB Aztec uses the same installation and engineering as our AB and AB Europa Collections, just with a new smooth, molded-face look that is subtle but impressive.



*AB Aztec Blend™ Pattern*

From the AB Aztec Collection, blend the AB Aztec Classic, AB Aztec Lite Stone, AB Aztec Junior and the AB Aztec Junior Lite (if available) together to create patterned walls.

Table 1

AB Aztec Collection™					
Classic Cut Stone	Name	Setback	Coverage	Weight	Approximate Dimensions
	AB Aztec Classic	6°	1 sq ft. approx. 11 blk per m <sup>2</sup>	75 lbs 34 kg	8 in. H x 12 in. D x 18 in. L 200mm H x 300mm D x 460mm L
	AB Aztec Junior	6°	0.5 sq ft. approx. 22 blk per m <sup>2</sup>	35 lbs 16 kg	8 in. H x 9.5 in. D x 9 in. L 200mm H x 240mm D x 230mm L
	AB Aztec Lite Stone	6°	0.5 sq ft. approx. 22 blk per m <sup>2</sup>	35 lbs 16 kg	4 in. H x 12 in. D x 18 in. L 100mm H x 300mm D x 460mm L
	AB Aztec Junior Lite	6°	0.25 sq ft. approx. 45 blk per m <sup>2</sup>	18 lbs 8 kg	4 in. H x 12 in. D x 9 in. L 100mm H x 300mm D x 230mm

Actual dimensions, weights and setbacks will vary by manufacturer. Check with your local Allan Block Dealer for exact specifications, block and color availability. Cap blocks are also available.





AB Aztec Collection

### *AB Aztec Collection and AB Aztec Blend Patterns*

Inspired by the walls in Cusco, Peru. Offering a pleasant, flowing feel of movement in the look.

Available in beautiful blended colors that offer a contemporary feel, the AB Aztec Collection is a brand new look in retaining walls. Use one block shape or a combination to build impressive patterned walls for outstanding results.



AB Aztec Collection

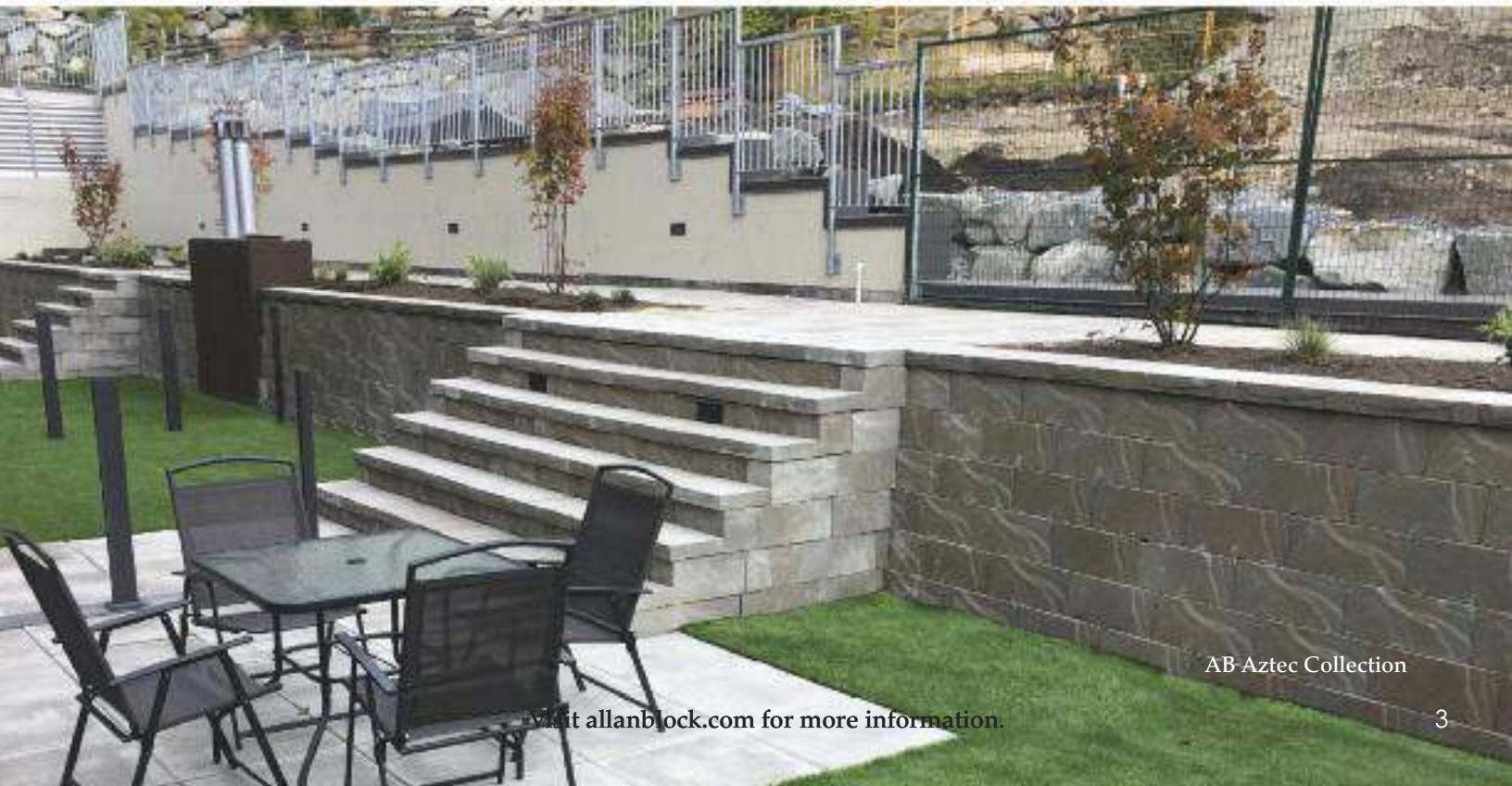

AB Aztec Collection



allanblock.com

**New Product**

Facing Series: Sierra  
Color: Rustic Creek

**AB Fieldstone Collection®**  
**The First "Green" Concrete Retaining Wall System**

AB Fieldstone is our "Green" retaining wall product. This two-piece system has a facing unit and an anchoring unit. When combined make for a new innovative retaining wall block that is lighter-weight and user friendly. Allan Block has opened the door to many benefits that are not only **Green**, but **Natural** and **Friendly** as well.



Anchoring unit - available in two universal sizes and produced with local recycled materials.

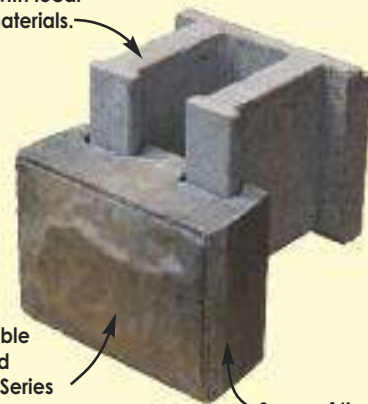

Facing unit - available in different sizes and Series styles. Each Series has varied block faces to ensure a random look, just like you would see in nature.

Some of the facing units are manufactured with a textured side eliminating the need for extra blocks when building corners or ending walls.

Table 2

AB Fieldstone Collection®					
	Name	Setback	Coverage	Weight	Approximate Dimensions
	812 facing unit with SAU	6°	0.7 sq ft. approx. 16 blk per m <sup>2</sup>	60 lbs 30 kg	8 in. H x 13 in. D x 12 in. L 200mm H x 330mm D x 300mm L
	812 facing unit with LAU	6°	0.7 sq ft. approx. 16 blk per m <sup>2</sup>	90 lbs 40 kg	8 in. H x 23 in. D x 12 in. L 200mm H x 585mm D x 300mm L
	824 facing unit with SAU	6°	1.3 sq ft. approx. 8 blk per m <sup>2</sup>	125 lbs 55 kg	8 in. H x 13 in. D x 24 in. L 200mm H x 330mm D x 600mm L
	824 facing unit with LAU	6°	1.3 sq ft. approx. 8 blk per m <sup>2</sup>	185 lbs 85 kg	8 in. H x 23 in. D x 24 in. L 200mm H x 585mm D x 600mm L

Actual dimensions, weights and setbacks will vary by manufacturer. Check with your local Allan Block Dealer for exact specifications, block and color availability. Cap blocks are also available.



SAU - short anchoring unit, LAU - long anchoring unit



Facing Series: Heritage  
Color: Natural



### *AB Fieldstone - Green, Natural and Friendly*

The back of the AB Fieldstone is the anchoring unit which is made from recycled materials. The front of the block is the facing unit which is made to emulate the look of natural stone. By putting them together we have the best of both worlds - a recycled product that maintains a beautiful and distinctive look of natural stone.

The manufacturing process of the facing units allow them to have many differing natural looks, styles and colors, which are called *Series*. There are currently four *Series* to choose from, the Sierra, Cascade, Colonial and Heritage Series, with additional ones in development (see [allanblock.com](http://allanblock.com)).

This user-friendly product has unlimited possibilities.



Facing Series: Colonial and Sierra  
Color: Rustic Creek



Facing Series: Sierra  
Color: Sandstone



allanblock.com

### AB Europa® Collection

The **AB Europa Collection** captures the hand-laid stone effect that brings distinction to any project. The blocks can be used separately or blended together for outstanding results. The unique texture creates a stunning look and gives old world charm to any landscape.



### AB Abbey Blend™ Pattern

From the AB Europa Collection, blend the AB Dover, AB Palermo, AB Barcelona and the AB Bordeaux together to create patterned walls.

Table 3

AB Europa® Collection					
Old World Antique	Name	Setback	Coverage	Weight	Approximate Dimensions
	AB Dover	6°	1 sq ft. approx. 11 blk per m <sup>2</sup>	80 lbs 36 kg	8 in. H x 10.5 in. D x 18 in. L 200mm H x 265mm D x 460mm L
	AB Palermo	6°	0.5 sq ft. approx. 22 blk per m <sup>2</sup>	35 lbs 16 kg	8 in. H x 9.5 in. D x 9 in. L 200mm H x 240mm D x 230mm L
	AB Barcelona	6°	0.5 sq ft. approx. 22 blk per m <sup>2</sup>	40 lbs 18 kg	4 in. H x 10.5 in. D x 18 in. L 100mm H x 265mm D x 460mm L
	AB Bordeaux	6°	0.25 sq ft. approx. 45 blk per m <sup>2</sup>	20 lbs 9 kg	4 in. H x 10.5 in. D x 9 in. L 100mm H x 265mm D x 230mm L

Actual dimensions, weights and setbacks will vary by manufacturer. Check with your local Allan Block Dealer for exact specifications and color availability. Caps and corner blocks are also available.







### *AB Europa Collection and AB Abbey Blend Patterns*

The pleasing aesthetics of the AB Europa Collection make it the best choice when looking to add an old world element to your outdoor living space.

Available in beautiful blended colors with an elegant, time-worn feel, the AB Europa Collection is sure to please. Use one block shape or a combination to build impressive patterned walls for outstanding results.





allanblock.com

## AB® Collection

The **AB Collection** gives a smooth fluid finish to any outdoor living space. Use the blocks individually or blend them together to create patterned walls that will define your space for years to come. Enjoy the beauty and durability of this collection's classic cut stone look that adds distinguished style to any landscape.



### AB Ashlar Blend™ Pattern

From the AB Collection, blend the AB Classic, AB Lite Stone, AB Jumbo Junior and the AB Junior Lite (if available) together to create patterned walls.

Table 4

AB® Collection					
Classic Cut Stone	Name	Setback	Coverage	Weight	Approximate Dimensions
	AB Stones <i>Best Single Block Choice</i>	12°	1 sq ft. approx. 11 blk per m <sup>2</sup>	75 lbs 34 kg	8 in. H x 12 in. D x 18 in. L 200mm H x 300mm D x 460mm L
	AB Jumbo Jr	6°	0.5 sq ft. approx. 22 blk per m <sup>2</sup>	35 lbs 16 kg	8 in. H x 9.5 in. D x 9 in. L 200mm H x 240mm D x 230mm L
	AB Lite Stone	6°	0.5 sq ft. approx. 22 blk per m <sup>2</sup>	35 lbs 16 kg	4 in. H x 12 in. D x 18 in. L 100mm H x 300mm D x 460mm L
	AB Junior Lite	6°	0.25 sq ft. approx. 45 blk per m <sup>2</sup>	18 lbs 8 kg	4 in. H x 12 in. D x 9 in. L 100mm H x 300mm D x 230mm
	AB Classic	6°	1 sq ft. approx. 11 blk per m <sup>2</sup>	75 lbs 34 kg	8 in. H x 12 in. D x 18 in. L 200mm H x 300mm D x 460mm L

Actual dimensions, weights and setbacks will vary by manufacturer. Check with your local Allan Block Dealer for exact specifications and color availability. Caps and corner blocks are also available.





### *AB Collection and AB Ashlar Blend Patterns*

Any outdoor space should be designed to be a functional extension of your home and garden. The AB Collection is the perfect choice for small garden walls up to taller retaining walls.

The modular blocks allow you to create beautiful patterns so you can have the landscape of your dreams with the traditional, clean line look of the AB Collection.

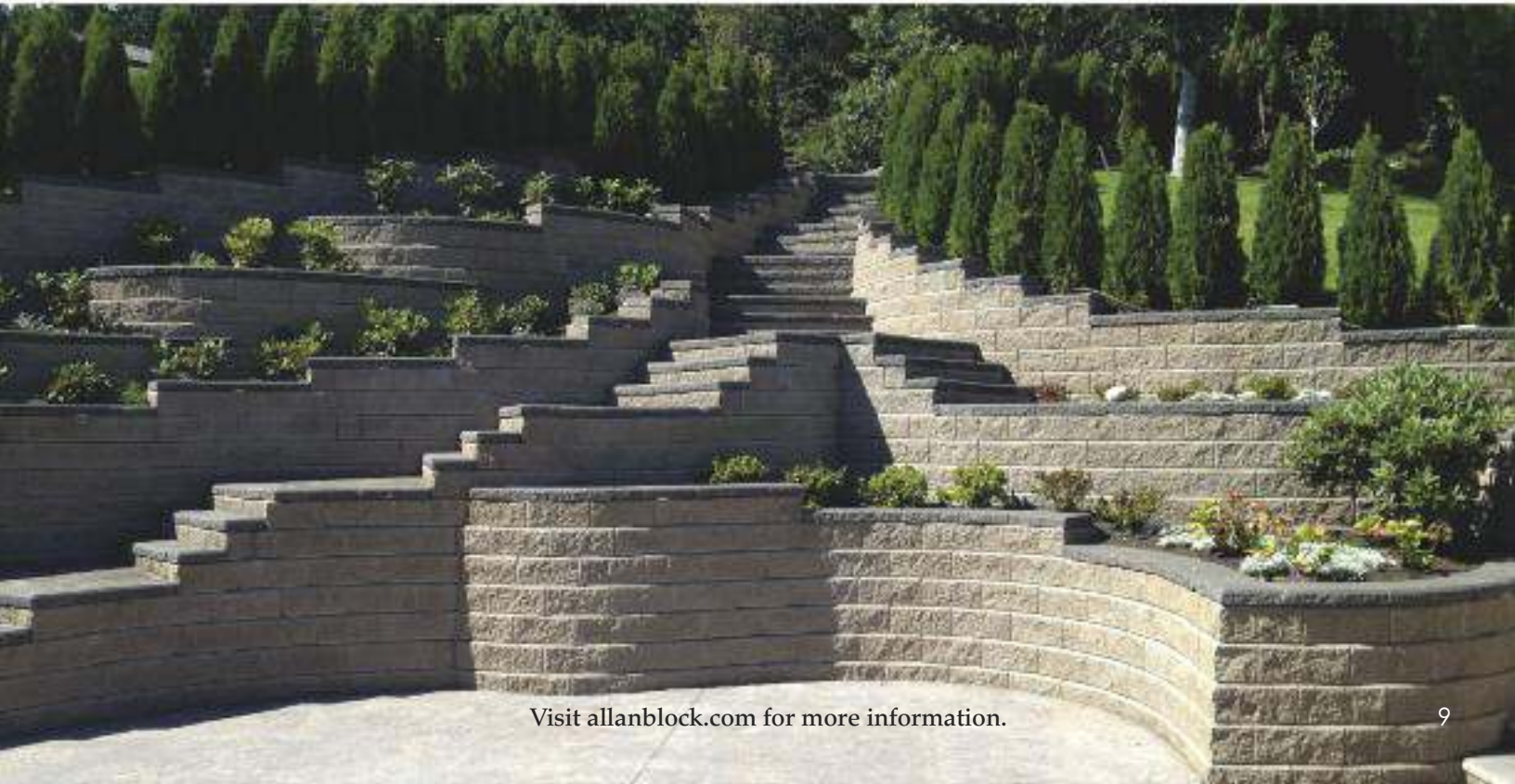

# Plan for Potential



allanblock.com



A detailed site plan drawn to scale will help foresee design and construction challenges and provide an accurate reference for estimating. This will become your working or approved plans for the project.

## Job Site Considerations

### Lot Lines

Your city will have a copy of your lot survey on file. The survey will not only identify property lines, but will provide an accurate scaled template of your site to help with planning.

### Utilities

Buried utility lines are not only dangerous, they may prevent you from locating your landscape project where you want. Call the local utility companies and have these lines marked.

### Permits

Building permits may be required if the wall is above a certain height. Check to see what your local city code requires. An approved engineered wall design or an Allan Block pre-engineered solution may be needed in order to get a building permit. Contact your local AB Dealer for more details.

### Neighbors

It's always nice (and smart too) to let your neighbors know about your project before you begin.

### Soils

**Clay soils put more pressure on a wall than sandy soils because they hold moisture. Identify the soils at your site.**

To identify the soils, a good test is to pick up a small handful of the soil in the palm of your hand and squeeze it to form a ball. Take a sample from at least 12 in. (300 mm) below the surface.



### Clay Soils

Clay soil will stick together to form a ball. Clay soils retain moisture which will add pressure behind the walls. Typically most soils will be classified as clay and can be used in your project. However, they may require additional reinforcement.



### Sandy Soils

Sandy soil, will not stick together because they are granular with no silty fine particles. These soils allow for good drainage and are ideal for building walls.



### Organic Soils

Organic soils will stick together but will not hold once the pressure is released. They should only be used to finish off the top 8 in. (200 mm) of a wall.

**NEVER use organic soils to build the wall.**

# What affects wall design? Consider the possibilities.



## Vegetation and the Environment

Existing trees and other vegetation can be designed into the wall layout as needed. New plantings can be added to enhance the total landscape. Any plantings directly behind the wall need to be done carefully as not to disturb any reinforcement that may have been added when the wall was built.

## The Base or Foundation

**You must build on solid ground.** If your site has soft, wet soils, or if the area was previously excavated, the foundation's soil may need to be replaced with good base materials and firmly compacted.



## Determining Wall Height

A detailed understanding of the site elevations and grade changes are needed to determine wall heights. Starting at the lowest point, mark your grade changes in 1 ft. (0.3 m) increments on the plan. Sketch in the drainage patterns.



## Cut and Fill

If building on a hill or a slope, the placement of your wall will determine how much soil will need to be removed or brought onto the site.

A "cut" site is where you cut into the hillside and remove the soil. You will need to decide ahead of time what will be done with the excess soil.

A "fill" site is where you will need extra soils to fill in behind the entire wall. You will need to plan ahead to have good backfill materials brought onto the site.



Visit [allanblock.com](http://allanblock.com) for more information.

## Reasons for Landscaping

Create Curb Appeal

Add an Outdoor Patio or New Living Area

Build a Raised Garden

Increase Your Usable Space

Feature Water Accents

Beautify Your Entryway

Correct a Drainage Problem

Enhance Your Landscape with Flowing Curves, Stairways or Planters

## Imagine the Possibilities

# Designing a Retaining Wall



allanblock.com



*The first step is to determine if you need a Gravity or Reinforced Wall.*

## Gravity Walls

Gravity walls rely on their own weight and setback to hold up the soil behind them.

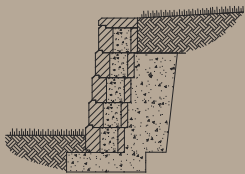

Please note that the gravity wall chart provided has specific heights for specific site and soil conditions. If you are not sure of your site conditions we recommend being conservative with your wall heights or use geogrid in your wall. See our geogrid wall chart on page 25.

## Reinforced Walls

Reinforced walls use layers of geogrid to combine the soil and block together to form a reinforced soil mass.

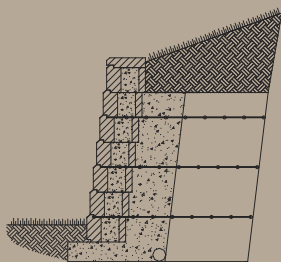

**Chart Example:** A 5 ft. (1.5 m) tall wall in sandy soil with a level surface above can be built with AB Stones of the AB Collection and would typically not require reinforcement, but will require review by a local professional engineer.

*Without exception your wall and landscape will come together with a detailed design.*

Use the chart below to find the maximum height that the wall can be built before reinforcement is required. Typically most soils will be considered clay. For sand conditions outlined in the table the soil must be a clean, granular material. See page 10 for information on soil types and descriptions.

Table 5

Maximum Wall Heights - AB Gravity Walls Residential Applications					
Condition above retaining wall	Soil Type	AB Stones only of AB Collection 12° (Ref)	AB, AB Aztec & AB Europa Collections 6° (Ref)	AB Fieldstone Short Anchoring Unit (SAU) 6° (Ref)	AB Fieldstone Long Anchoring Unit (LAU) 6° (Ref)
Level	Clay	3 ft. 6 in. 1.0 m	3 ft. 2 in. 0.9 m	3 ft. 7 in. 1.1 m	5 ft. 10 in. 1.8 m
	Silty Sand	5 ft. 4 in. 1.6 m	4 ft. 7 in. 1.4 m	5.0 ft. 1.5 m	8 ft. 6 in. 2.6 m
Wall Heights listed are for reference only.					
Surcharge* 100 psf (4.7 kPa)	Clay	1 ft. 8 in. 0.5 m	1 ft. 4 in. 0.4 m	1 ft. 8 in. 0.5 m	4 ft. 1.2 m
	Silty Sand	3 ft. 10 in. 1.1 m	3 ft. 1 in. 0.9 m	3 ft. 7 in. 1.1 m	7.0 ft. 2.1 m
Wall Heights listed are for reference only.					
Slope 3:1	Clay	2 ft. 8 in. 0.8 m	2 ft. 4 in. 0.7 m	2 ft. 8 in. 0.8 m	4 ft. 4 in. 1.3 m
	Silty Sand	4 ft. 8 in. 1.4 m	4 ft. 1 in. 1.2 m	4 ft. 4 in. 1.3 m	7 ft. 4 in. 2.3 m
Wall Heights listed are for reference only.					

Table 5 is based on Clay soil having an internal friction angle of 27° (Ref) or better and a Sandy soil having an internal friction angle of 32° (Ref) or better. All heights based on exposed wall heights and include a cap block. The gravity wall heights shown above do not account for seismic loading. Check with a local engineer for assistance if you are in a seismic area. Final designs for construction purposes must be performed by a local registered Professional Engineer, using the actual conditions of the proposed site. \*The Surcharge loading category above assumes a solid surface such as concrete, asphalt or pavers having a suitable supporting subgrade.

Visit [allanblock.com](http://allanblock.com) for more information.

# Conditions above and behind the wall will determine how tall the wall can be before reinforcement is needed.

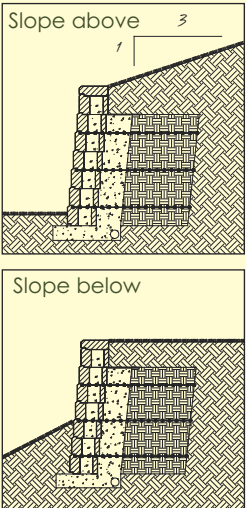
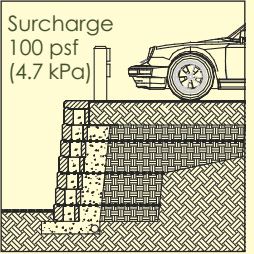
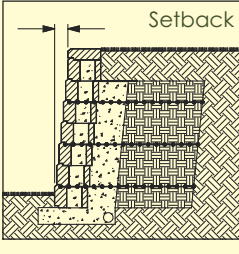
Slopes	Surcharges	Setback
<p>A slope above the wall will add more pressure and weight, while slopes below the wall may make the wall unstable due to sliding or erosion. Avoid slopes greater than 3 to 1 without first consulting a local engineer.</p> 	<p>Any added weight above your wall is called a "surcharge". Patios, swimming pools and driveways are common residential surcharges. Your wall may need additional support if a surcharge is present. For commercial applications contact an engineer. See the <i>Soil Reinforcement Chart</i> on page 25.</p> 	<p>The amount your wall leans into the hill is called "setback". AB blocks come in approximate setbacks of 6° and 12°. The 12° (Ref) setback will provide better leverage and require less reinforcement.</p> 

## When the Wall Needs Reinforcement

Under certain conditions, the block weight and setback alone do not provide enough structural support. Allan Block's Reinforcement Grid™ provides a simple solution by creating a solid structure with more resistance to soil pressure and surcharges. AB Reinforcement Grid is simple to install; just roll it out along the wall on the appropriate courses for residential walls under 6 ft. (1.8 m) tall.



AB Reinforcement Grid is bi-axial (strong in both directions) and can be simply rolled out along the wall. Other geogrids are uni-axial (strong in only one direction) and must be installed running from the front of the block to the back of the excavated area.

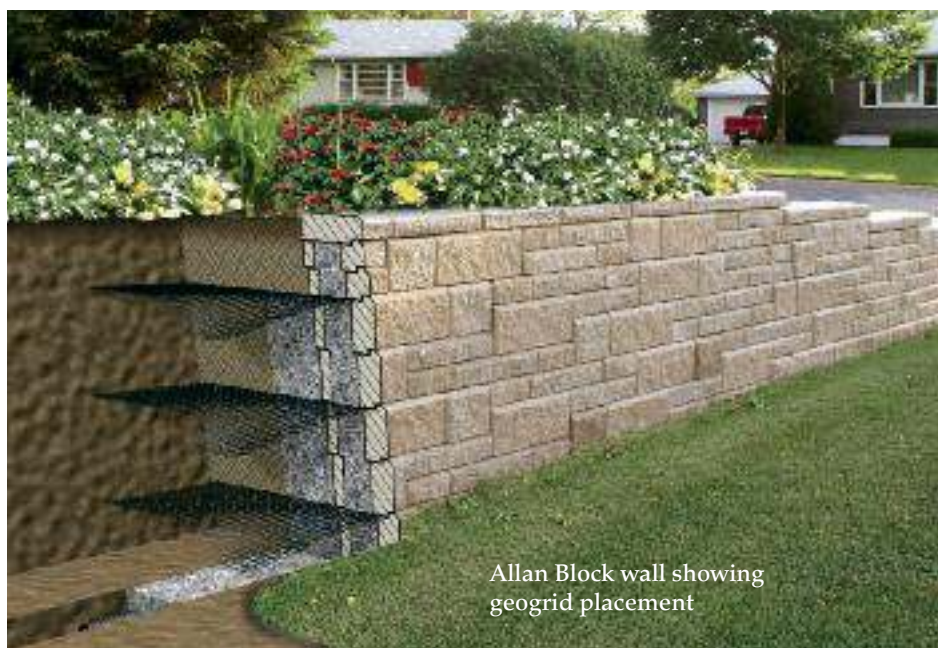

Contact your local Allan Block Dealer for AB Reinforcement Grid and detailed installation instructions.



AB Reinforcement Grid is available in 2 sizes: 3 ft. and 4 ft. rolls that are 50 ft. long (0.9 m and 1.2 m by 15 m). Use the chart on page 25 to find which size you need and how many layers your wall requires.

# Design for Style



allanblock.com

Whether you choose soft curved walls or classic straight walls, Allan Block has the system to satisfy every design.

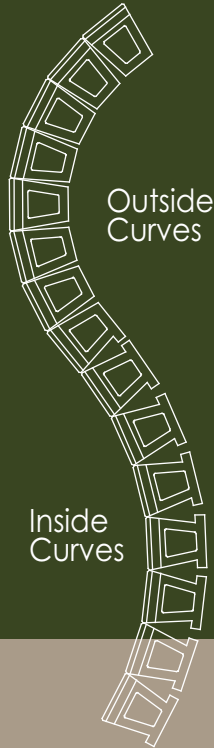

AB Europa Collection  
AB Abbey Blend Pattern

Flowing inside curves are achieved by a consistent spacing between the backs of the blocks as you build.

To build smooth outside curves, remove one or both of the wings on the back of the blocks.



Try to maintain at least 1/4 of the block length offset from the block below as you build curves. Perfect "running bond" is not necessary with Allan Block.



AB Europa Collection  
Outside Corner



AB Europa Collection  
AB Abbey Blend Pattern

Curves accent any landscape, are simple to design and easy to build. Consider how tight or gentle you want the curves to be and choose the block or combination of blocks that are best suited for your design. See the radius chart on page 33 for more information.

## Corners & Angles

### Outside Corners

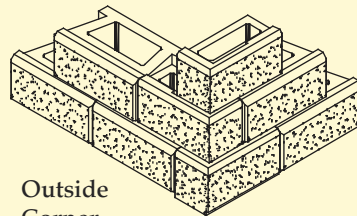

Outside Corner

For the AB, AB Aztec and AB Europa Collections: **Outside Corners** are constructed using Allan Block Corner units and take more time and skill. See page 34 for information on building with corners.

For the AB Fieldstone Collection: **Outside Corners** are constructed using the standard facing and anchoring units. See page 35 for information.

### Inside Corners

Inside corners are easily constructed using standard Allan Block units. By removing part of the lip with a chisel or saw, the blocks can be overlapped for a strong interlock. See page 34 for more information.



Outside Corner

AB Fieldstone Collection  
Facing Series: Sierra  
Color: Rustic Creek

Visit [allanblock.com](http://allanblock.com) for more information.



# Patterned Walls

AB Collection  
AB Ashlar Blend Pattern



Inside and Outside Corners

AB Europa Collection  
AB Abbey Blend Pattern

*Give your landscape a dramatic effect with the AB Ashlar or AB Abbey Blend patterned walls from the Allan Block Collections.*

*Add a whole new dimension to your landscape! Blend the different sized blocks together into your wall and capture the look of hand-laid stone.*

**Helpful Hints**  
Try to build away from corners and avoid small cut blocks at the corners.  
Soft curves are easier to build than angles.

## Angles vs. Curves

**Angles** typically require custom cutting of the blocks. Try to design curves instead. Angled walls are not as stable as curved walls.

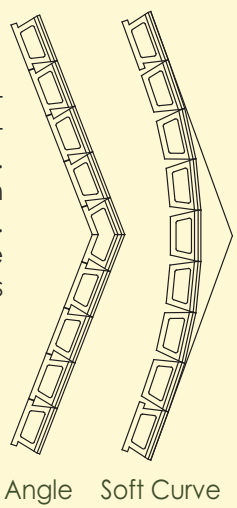

Angle Soft Curve

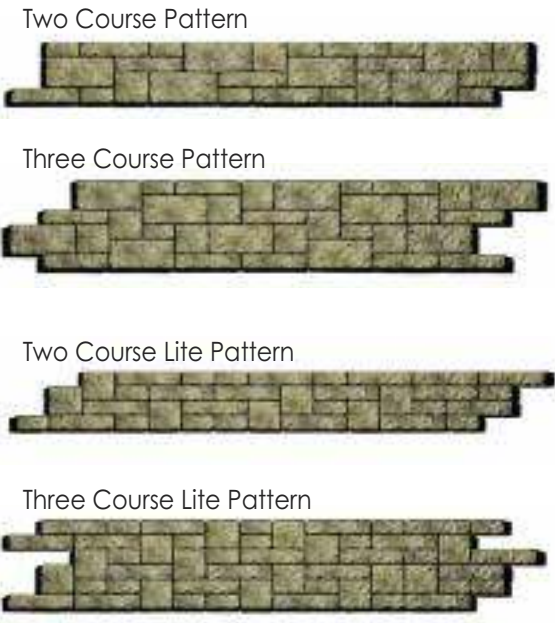

Choose from one of our pre-set patterns to build your wall, or create your own. Walls with curves or that require reinforcement must be constructed with a two course pattern. See page 26 for more information.

# Unlimited Design Options



allanblock.com



AB Europa Collection  
AB Abbey Blend Pattern

## Stair Design

Stairs can be easily designed with flowing curves or with right angles. The simplest stair designs are built using curves. Allow for extra time for laying out and building your stairs. See page 40 for more information.

## Stair Building Basics

Many stair design variations are possible. Stair layout for rise and run needs to be calculated with consideration to the stair tread that best suits your application.

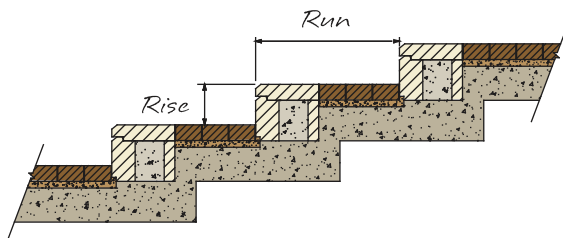
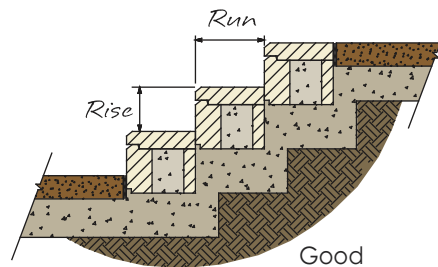

AB Collection

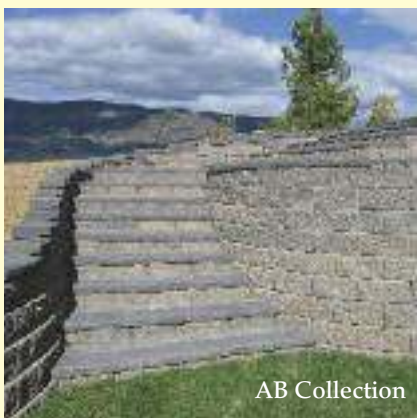

AB Collection

Allan Block's patented front lip provides a built-in edging that not only works with Allan Block Capstones but also with pavers, poured concrete, crushed rock, mulches and flagstones.

Ensure stair treads are secured in place for safe use. In colder climates, salt **CANNOT** be used on the blocks or AB Capstones as it will cause them to deteriorate.



AB Collection

# Create Lasting Value

## *In-Wall Planters and Terracing*

Terraced walls can create more usable space, tame slopes, build raised gardens or can give your yard a more aesthetic look. See page 44 for more information.

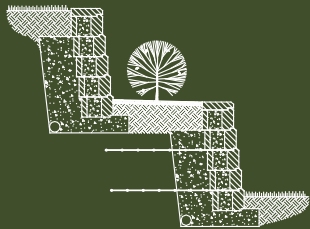

## *Planters*

Bring the ground to the gardener! Create easy garden beds that are easy to access and maintain.



## *Functionality*

Design walls that work with your landscape and add value. Low profile planters can make perfect seating or provide for easy access to gardening.

When designing terraces for planting, it is important to provide enough depth and area to sustain plant growth between the walls. This may require additional blocks to be buried on the upper wall.

## *Plantable Walls*

Plantable walls can be easily incorporated into your design. Planting areas are formed by simply stepping back the wall and planting in the exposed area. Ivy can also be planted at the bottom of the wall to grow up and cover the blocks.

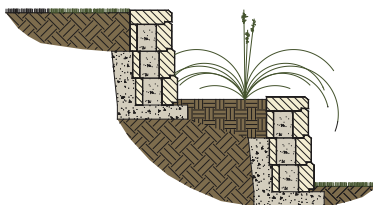

# Water Management



allanblock.com



## Where does the water go?

AB Collection

### Design for Water

The design and performance of most retaining walls are based on keeping the area behind the wall relatively dry. To ensure a quality project, the soils used must not become saturated during construction and the final design must route water away from the back of the wall. Incorporating berms and swales into the final design is an easy way to direct surface water away.

During the design process, develop a thorough understanding of the site and determine where water will come from and how it will be properly managed.

During the building process, stage your materials so surface runoff is not directed improperly. It is also a good practice to cover the infill soils and the entire wall project at the end of each day to prevent water saturation if rain is in the forecast.

Any reinforced wall or walls over 4 ft. (1.2 m) in height or with slopes or other surcharges above the wall will need a toe drain. In all cases wall rock is located within the cores of the block and a minimum of 12 in. (300 mm) behind the block. The toe drain and the wall rock is designed to remove incidental water from behind the wall and is not meant as primary drainage path for above or below grade water management.

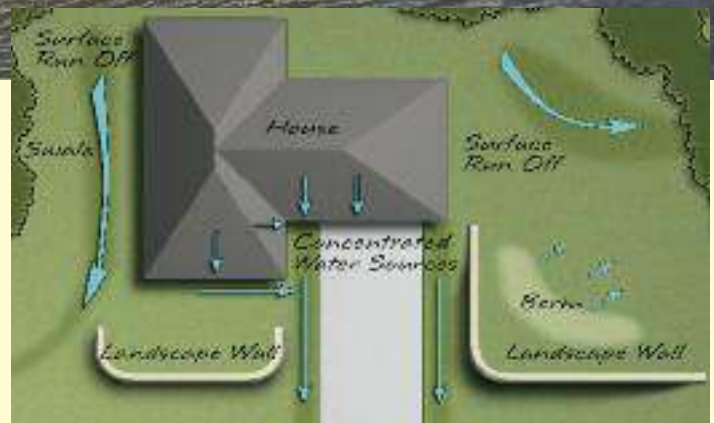

Swales

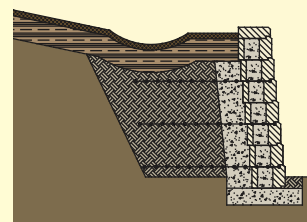

Berms

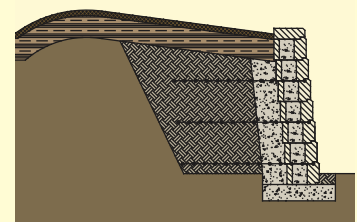

### Typical Drain

Drains must be vented to daylight or connected to a storm sewer system and must be protected from migration of fine material.

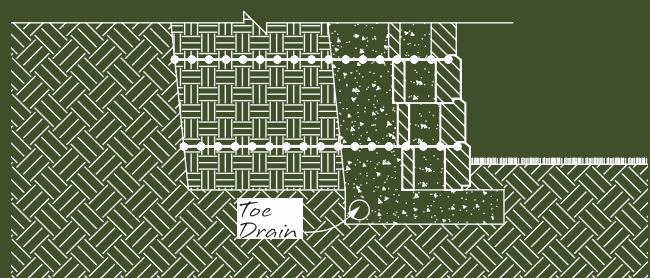

## Grading

During wall layout it is important to evaluate the entire site to determine if water will drain into the area where the wall will be constructed. Temporary grading may be needed to ensure water will not drain towards the construction area.

## Ground Water

Ground water can be defined as water that occurs within the soil. Sources include surface infiltration, water table fluctuation and layers of permeable soils. Ground water movement must be prevented from coming in contact with the wall structure, including the soils behind the wall.

If subsurface or ground water is encountered during construction, consult an engineer to ensure that the water has been accounted for in your design.

## Drain Pipes

Sites with poor draining soils, gravity walls over 4 ft. (1.2 m) tall and all reinforced walls will require a toe drain.

Drain pipes used in toe drain applications must be properly vented a minimum of every 50 ft. (15 m). To accomplish this, vent the drain pipe to daylight or a lower elevation on the site.

When venting to a lower elevation, it is important that all drain locations are properly marked and protected to ensure that the drain pipe is not damaged or plugged. Rodent screens can be used to allow the water to flow through the outlet pipes and keep the pathway clear of debris.

## When Do I Need Drain Pipes?

Follow these rules of thumb:

- All walls taller than 4 ft (1.2 m)
- Reinforced walls
- Sites with poorly draining soils
- Alongside paved areas
- With slopes above the wall
- On multi-tiered and terraced walls
- All commercial and municipal projects

### Vent thru the block face

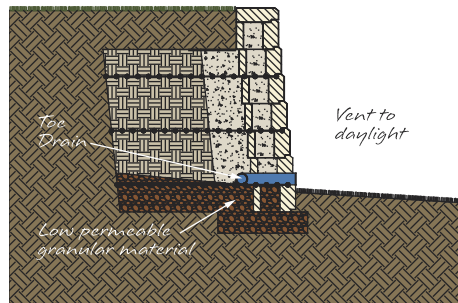

### Vent to a lower grade

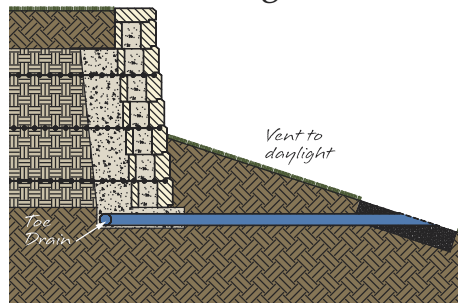

## Concentrated Water Sources

Prior to constructing the wall, review drainage plans and details to identify all potential sources of concentrated water.

Examples that must be accounted for are:

- Driveways
- Slopes above walls
- Grading of site
- Water lines, mains or fire hydrants
- Roof down spouts
- Sump pump outlets
- Irrigation systems

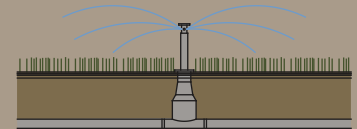

Use a drain pipe to route water from behind the wall. Attach tee fittings at 30 ft. to 50 ft. (9 to 15 m) intervals and direct the drains out through the wall face.



# Getting Ready



allanblock.com

*Always build on solid ground.*

## Remember

*Safety always comes first.*



## Tools & Equipment you may need

**HAND TOOLS** Safety glasses, gloves, dust mask, ear protection, knee pads, 4' level, torpedo level, tape measure, string line, chisel, hand tamper, dead blow hammer, shims, broom, round and square shovel.

**POWER TOOLS** Plate compactor, concrete saw with diamond blade, skid loader, transit/site level.

## Job Site Considerations

### Site Access

When planning your project, make sure you can access your wall site with construction equipment and materials. For sites with restricted access, plan out where you will stage and store your block, wall rock and other materials.



### Rental Equipment

Plate compactors, concrete saws, skid loaders and transit levels are very useful when building a retaining wall. These are available at most equipment rental centers.



### Wall Rock

To build a quality wall, use a clean, granular rock underneath the base course to create a firm foundation for your project. Good drainage and compaction will add to the quality and performance of your finished wall.

We refer to the material used for the base, within and behind the block as "Wall Rock". Wall Rock is a gravel in varying sizes, ideally from 0.25 in. to 1.5 in. (6 to 38 mm), of angular or smooth compactible aggregates with no sands, silts or clay material that would limit the free draining nature of the aggregate. Your AB Dealer will have what you need.



Visit [allanblock.com](http://allanblock.com) for more information.

## Working with Soils

The soils used below and behind the wall are a critical part of the total wall structure. A reinforced retaining wall contains four basic building materials - the AB blocks, wall rock, geogrid reinforcement, and the infill soils surrounding the geogrid layers.

## Soils

Understanding the properties and characteristics of soils is key to building better walls. Different soil types will dictate the amount of time needed for compaction, the amount of reinforcement required, and potentially the cost of the wall.

Granular soils are better to build with than clay soils. Sand and gravel will compact better, drain better, and often will need less reinforcement. Soils are typically defined by a friction angle or measurement of the internal strength of the soil. This angle is approximately the natural angle of repose. As soil falls off a conveyor to make a pile, the angle it creates represents the natural angle of repose. Check with a qualified geotechnical engineer to obtain an accurate soil classification.

## Soil Selection

If the on-site soils are of a very low quality under or behind the wall, you should remove and replace them with stronger soils. Using stronger soils will reduce reinforcement, allow faster compaction and have better long-term performance. Heavy clays and organic soils are both unsuitable in the reinforced zone and should be removed and replaced. Silty sands and sand with clay will require additional care, and attention to water management when placed and compacted.

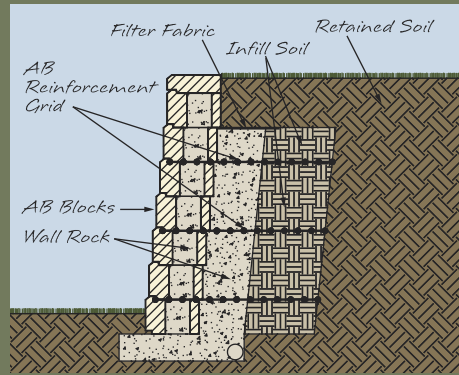

Preferred Granular Infill Material

## Natural Angle of Repose

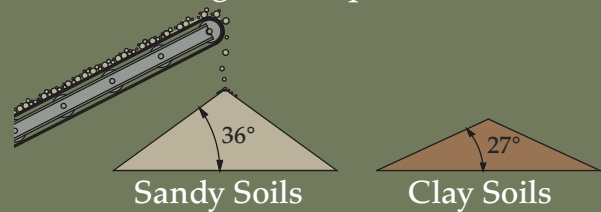

## Compaction

**Proper placement and compaction of the infill soils is critical.** The most important step in getting proper compaction is the placement of the soil in "lifts". Compacting in lifts, or layers, of less than 8 in. (200 mm) will facilitate quality compaction. Placement and compaction in lifts that exceed 8 in. (200 mm) will result in less than adequate soil strength. Compaction equipment must be sized according to the type of material being compacted. Always backfill and compact after each course of block is placed. Consult with a local equipment supplier to ensure that proper compaction equipment is used.

The consolidation zone runs from the back of the block back 3 ft. (0.9 m) into the infill soil. Only walk behind plate compaction equipment is allowed within the consolidation zone. A minimum of two passes with a walk behind plate compactor is required, starting on top of the block and compacting in paths that run parallel with the wall to the back of the excavated area.

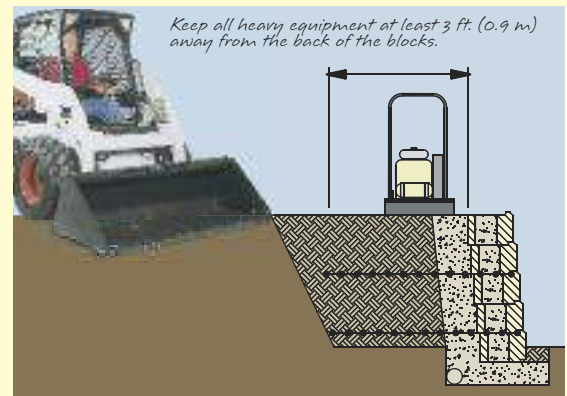
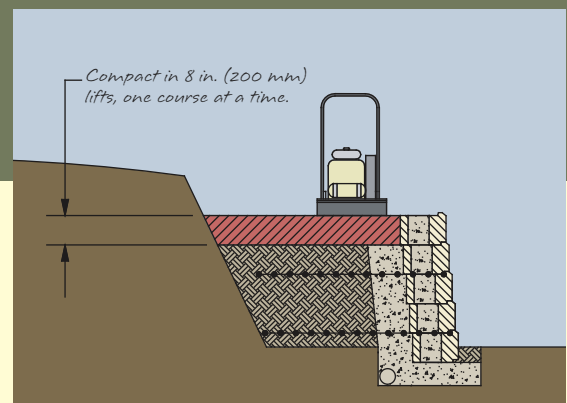

# Basic Installation



allanblock.com

## Building a retaining wall.

### Base Preparation

- To start your layout, place stakes to represent the location of the front of the wall. Using a string line or paint, mark out the entire length. A garden hose is an excellent tool to use when laying out curved walls.
- Excavate the area by removing all surface vegetation and organic materials from the area. **These cannot be used as backfill material.**
- If reinforcement is needed excavate behind the wall to accommodate the design length of the geogrid. Refer to your approved plans for exact length.
- Starting at the lowest point, dig a base trench the length of the wall. For walls where the base trench steps up a slope see page 38 for more information.
- Dig a base trench 24 in. (600 mm) wide the length of the wall.\*\*
- The depth of the trench will be 6 in. (150 mm) plus an additional 1 in. (25 mm) for each 1 ft. (300 mm) of wall height for the amount of buried block that is needed.\*\*
- Compact the base trench making a minimum of two passes with a walk behind plate compactor.
- **Foundation soils at the bottom of the base trench must be firm and solid.** If the soils are made up of heavy clay or wet soils, or the areas have been previously excavated, remove this material and replace with a granular material, compacting in 8 in. (200 mm) lifts or less.

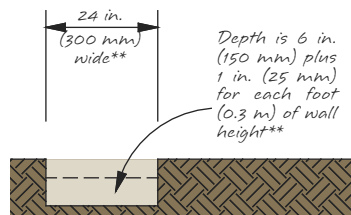

\*\* For walls under 4 ft. (1.2 m) dig the base trench 18 in. wide (460 mm) and 4 in. deep (100 mm) plus additional to account for the amount of buried block needed.

### Base Material

- A drain pipe is required for any reinforced wall, gravity walls over 4 ft. (1.2 m) tall or sites with poor drainage. Place the drain pipe at the lowest possible point toward the back of the trench and vent to daylight every 50 ft. (15 m). See approved plans for location and specifications. See page 19 for more information.
- Place a minimum of 6 in. (150 mm) of wall rock in the base trench and rake smooth.
- Compact the wall rock making a minimum of two passes with a plate compactor.
- Check the entire length for level, and adjust as needed.





## Install Base Course - AB and AB Europa Collection

See page 29 for AB Fieldstone walls.

- Begin the base course at the lowest wall elevation. For more information on stepping up the base course see page 38.
- Place all blocks with the raised front lip facing up and forward on the base material in the center of the base trench.
- Check and adjust each block for level and alignment as it is installed. Check the blocks for level frequently from side-to-side and front-to-back. Verify the proper position of all the AB blocks by examining a string line across the back of the blocks or by sighting down the back of the raised front lip.
- Make minor adjustments by tapping the AB blocks with a dead blow hammer or by placing up to 0.5 in. (13 mm) of coarse sand under the blocks.
- Irregularities in the base course become larger as the wall stacks up. Careful attention to a straight and level base course will ensure a quality finished wall.

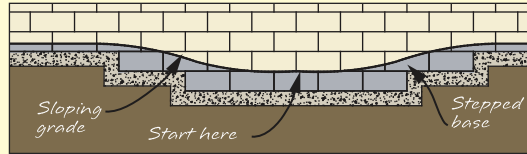

## Backfilling and Compaction

- Fill in the area in front of the blocks with on-site soils. This will keep the base course blocks from shifting while filling and compacting.
- Fill the hollow cores of the base course and 12 in. (300 mm) behind the block with wall rock to the height of the block.
- Use infill or approved on-site soils to backfill behind the wall rock in lifts of no more than 8 in. (200 mm).
- Use a plate compactor to consolidate the wall rock directly behind the block then compact in a path parallel to the wall, working from the back of the block to the back of the excavated area with a minimum of 2 passes. See page 21 for additional details on compaction.
- Check the base course for level and adjust as necessary.
- Every course after the first course requires compaction starting on the block.

## Additional Courses

See page 26 for building patterned walls.

- Remove all excess material from the top surface of all blocks. This can be done when installing the next course of block, by sliding the block into place.
- **If reinforcement is needed go to page 24 to continue the installation process.**
- Stack the next course of blocks so that the vertical seams are offset from the blocks below by at least 1/4 the length of the block.
- Check each block for level and alignment and make adjustments as needed.
- Fill the hollow cores and 12 in. (300 mm) behind the block with wall rock to the height of the block.
- Use infill or approved on-site soils to backfill behind the wall rock in lifts of no more than 8 in. (200 mm).
- From the 2nd course and above use a plate compactor to compact directly on the blocks as well as the area behind the blocks. Compact in lifts of 8 in. (200 mm) or less.
- Repeating these steps, complete the wall to the desired height. On the last course, fill behind the blocks with organic soils in place of infill or approved on-site soils. This will assist in any plantings above the wall and also to direct water from running behind the blocks. See page 54 for information on finishing wall options.

Running Bond



Stack the blocks in running bond or offset by at least 1/4 of the block

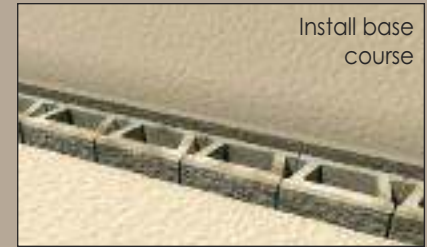
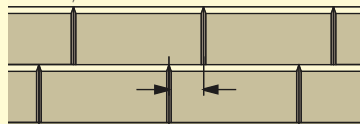

Install base course

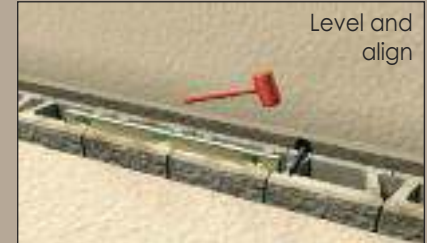

Level and align



Backfill wall rock and infill soils



Compact

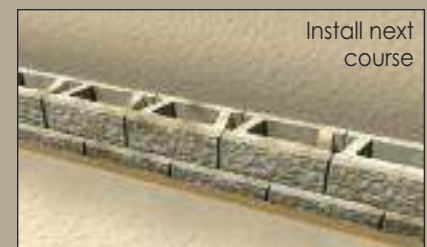

Install next course

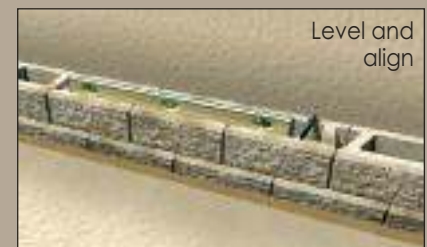

Level and align



Backfill and compact

# Geogrid Installation



allanblock.com

*Install geogrid on every other course as needed.*

## Install Reinforcement

- Once the base course is complete, begin installing the first layer of AB Reinforcement Grid. When using the AB, AB Aztec or AB Europa Collection begin by placing the edge of the geogrid against the back of the raised front lip and rolling it out along the wall. For AB Fieldstone, place the edge of the geogrid in the middle of the facing unit. Refer to your approved plans for exact size and location.
- Stack the next course of blocks so that the vertical seams are offset from the blocks below by at least 1/4 the length of the block.
- Sight down the wall line to check for alignment. Blocks may be adjusted slightly to form straight lines or smooth flowing curves.
- Pull on the back of the geogrid to remove any slack. If necessary, stake it in place. Never drive or compact directly on the geogrid. This will cause damage to the geogrid.



Install AB Reinforcement Grid

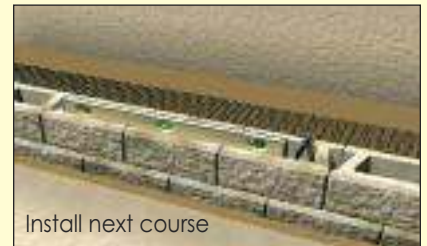

Install next course

## Backfilling and Compaction

- Install wall rock in the block cores and 12 in. (300 mm) behind the block. Use infill or approved on-site soils to backfill behind the wall rock to the height of the block.
- The wall rock and infill soils behind the wall must be properly compacted using a plate compactor. Compact in lifts of 8 in. (200 mm) or less, this time starting on the block and working in a path that runs parallel to the block and towards the back of the excavated area. **Always make a minimum of two passes with a plate compactor. Compaction should be continued to achieve solid, movement-free soil.**
- Remove all excess material from the top surface of all blocks. This prepares a clean, smooth surface for placement of the next course.

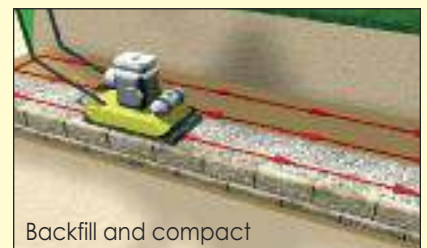

Backfill and compact

## Additional Courses

- Continue installing your next courses of block using the steps shown above. Per your approved plans, install geogrid on every other course of the wall.
- Using these steps complete the wall to the desired height. On the last course, fill behind the blocks with organic soils in place of infill or approved on-site soils. This will assist in any plantings above the wall and also to direct water from running behind the blocks. See page 54 for information on finishing wall options.

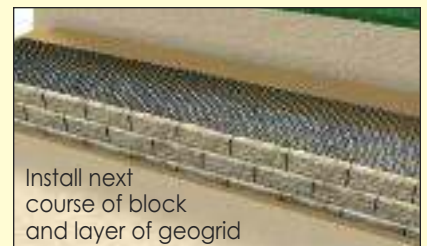

Install next course of block and layer of geogrid

## Reinforcement Chart

Match your wall to the conditions below to find which width and the number of layers of AB Reinforcement Grid you will need. To determine the number of rolls needed, multiply the length of your wall (in feet) by the number of layers needed, and then divide by 50 (the length of a roll of AB Reinforcement Grid). Typically most soils will be considered clay, for sandy conditions outlined in the table the soil must be a clean, granular material. See page 10 for information on soil types and descriptions.

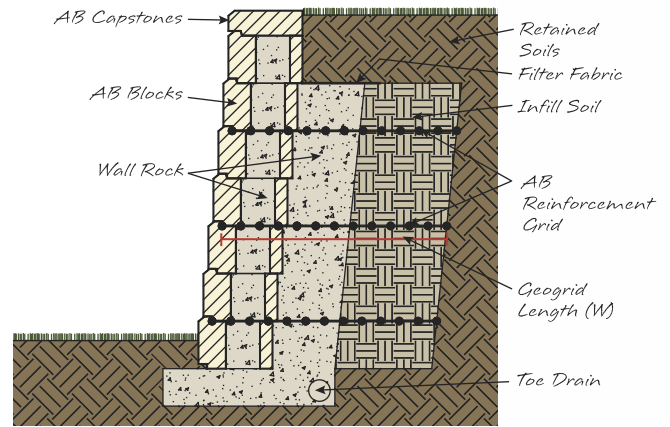

Table 6

Soil Reinforcement Chart for Residential Wall Applications									
CONDITION ABOVE WALL	WALL HEIGHT**	AB Stones of the AB Collection only				AB, AB Aztec, AB Europa and AB Fieldstone Collection (excl. AB Stones)			
		CLAY SOIL		SANDY SOIL		CLAY SOIL		SANDY SOIL	
		No. of Layers	Width (W)	No. of Layers	Width (W)	No. of Layers	Width (W)	No. of Layers	Width (W)
Level	3ft (0.9 m)	0	0	0	0	0	0	0	0
	4ft (1.2 m)	2	3 ft	0	0	2	3 ft	0	0
	5ft (1.5 m)	3	3 ft	0	0	3	4 ft	3	3 ft
	6ft (1.8 m)	4	4 ft	4	4 ft	4	4 ft	4	4 ft
Surcharge* 100 psf	2ft (0.6 m)	1	3 ft	0	0	1	3 ft	0	0
	3ft (0.9 m)	2	3 ft	0	0	2	3 ft	0	0
	4ft (1.2 m)	2	3 ft	0	0	2	3 ft	2	3 ft
	5ft (1.5 m)	3	3 ft	3	3 ft	3	3 ft	3	3 ft
	6ft (1.8 m)	4	4 ft	4	4 ft	4	4 ft	4	4 ft
Slope 3:1	3ft (0.9 m)	2	3 ft	0	0	2	3 ft	0	0
	4ft (1.2 m)	2	3 ft	0	0	2	3 ft	2	3 ft
	5ft (1.5 m)	3	4 ft	0	0	3	4 ft	3	3 ft
	6ft (1.8 m)	4	4 ft	4	4 ft	4	4 ft	4	4 ft

\*\* Wall heights are for reference only.

### Example

Using a block from the AB Collection, a 5 ft high wall (1.5 m) built in sandy soil with a level surface above the wall requires three layers of geogrid, 3 ft wide (0.9 m), but will require review by a local professional engineer.

### Larger Geogrid Rolls

Large roll geogrids are strongest along the roll or machine direction and are cut to the design length. They are best suited for walls over 6 ft. (1.8 m) high.



### AB Reinforcement Grid™

AB Reinforcement Grid is biaxial which means it has the same strength in both directions and can be simply rolled out along the wall. It is available in 3 ft. and 4 ft. rolls and is 50 ft. long (0.9 m and 1.2 m by 15 m) and is best used for residential walls under 6 ft. (1.8 m) tall as outlined in the table above.

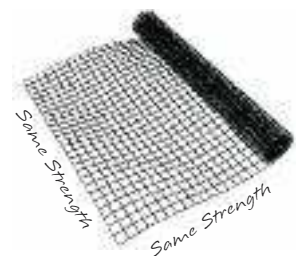

When placing geogrid along curving walls, the geogrid should follow the back of the lip. Simply slit the geogrid with a utility knife and either feather out or overlap to follow the curve. See page 36 for more information.

Outside Curves

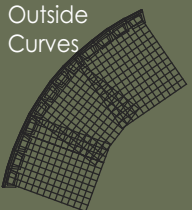

Inside Curves

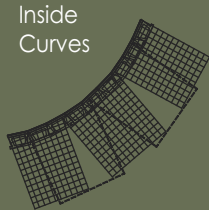

When placing geogrid at corners, simply lay the geogrid into the corner and cut to fit with a utility knife. See page 37 for more information.

Inside Corners

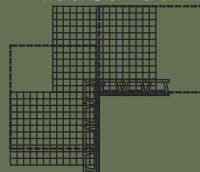

Outside Corners

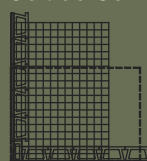

**REINFORCEMENT GRID™**



Visit [allanblock.com](http://allanblock.com) for more information.

# Patterned Walls



allanblock.com

*Add distinction to your landscape.*

AB Collection  
AB Ashlar Blend Pattern

## *Excavate and Install Base Course*

**The base course should always use a full course of full-sized blocks. This will speed the leveling and installation of the first course.**

- Refer to page 22 for a detailed description on how to install the base course. Basic steps include: site prep and excavation, installing base material, base course, wall rock, backfill materials and compacting.

## *Install Reinforcement*

- Check your approved plans for exact size and course location for the AB Reinforcement Grid. See page 25, 36 & 37 for more information on using geogrid.
- Install the first layer of geogrid by placing the edge of the geogrid against the back of the raised front lip and rolling it out along the wall.

## *Install the Multiple-Course Pattern*

- The example shown here uses a 2 course pattern. See page 28 for more information on pattern options.
- Stack the first course of the pattern on top of the geogrid and the base course.
- Check blocks for level, and make adjustments as needed. Pull on the back of the geogrid to remove any slack. If necessary, stake in place.
- Install the wall rock in the block cores and 12 in. (300 mm) behind the blocks to the height of the blocks.
- Compact inside the block cores using a shovel handle. Check blocks for level. See page 27 for more information on compaction in the block cores.
- Use infill or approved on-site soils to backfill behind the wall rock in 8 in. (200 mm) lifts or less. The top of the blocks will not always match up with each lift of soil. Check blocks for level.



Bi-Axial AB Reinforcement Grid™



AB Collection  
AB Ashlar Blend Pattern



Install geogrid



Install first course of pattern on top of geogrid



Install wall rock

- Using a plate compactor, compact the wall rock and infill materials behind the block in 8 in. (200 mm) lifts or less. Compact directly behind the blocks in a path parallel to the wall, working from the back of the wall to the back of the excavated area. Always make a minimum of two passes with a plate compactor.
- Install the remainder of the 2 course pattern. Install wall rock in the block cores and behind the blocks as before so they are level with the top course of the blocks. Use infill or approved on-soils to backfill behind wall rock. Check blocks for level. If using a custom pattern, remember to offset the vertical seams by at least 1/4 of the block whenever possible.

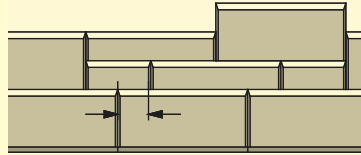

Offset by at least 1/4 of the block

- With the first multiple-course pattern completed, use a plate compactor to compact the wall rock in the block cores and directly behind the blocks. The first pass of the plate compactor should be directly over the top of the block cores.
- Compact in a path parallel to the wall, working from the front of the block to the back of the excavated area. Make a minimum of two passes with a plate compactor. Check blocks for level.

**NOTE: Keep all heavy equipment at least 3 ft. (0.9 m) away from the back of the wall.**

### Install the Second Multiple-Course Pattern

- Refer to your approved plans to determine if reinforcement will be required. If so, repeat the previous process to install geogrid between the patterns.
- Install the next pattern section as done in the previous steps. Each additional pattern will need to be offset from the pattern below to avoid a repetitive look. Remember to offset the vertical seams by at least 1/4 of the block whenever possible.
- Two course patterns should be selected for most projects. Three course patterns can be used for gravity walls or to top off a reinforced wall where geogrid is not required within the top three courses.

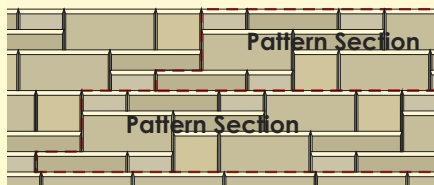

### Ending and Topping off the Wall

- Finishing a patterned wall is the same as finishing a standard wall. See page 54 for finishing wall options. The only requirement is that a multiple course pattern must be completed so that the top course of the blocks forms a level surface.
- On the last course, fill behind the blocks with organic soils in place of infill or approved on-site soils. This will assist in any plantings above the wall and also to direct water from running behind the blocks.

### Compacting Patterned Walls

Compaction in the block cores needs to be done regularly when working with patterned walls. This can be done by using the end of a shovel to compact the wall rock, adding additional rock if necessary.



At each 8 in. (200 mm) lift, compact the block cores with the end of a shovel, and the area directly behind the block with a plate compactor per the procedures described in this guide.

At the conclusion of each pattern, the top of the wall will be level. Run the plate compactor over the top of the blocks to consolidate the wall rock. Place geogrid if required, and begin the next pattern.



Compact behind blocks



Finish pattern, level and align

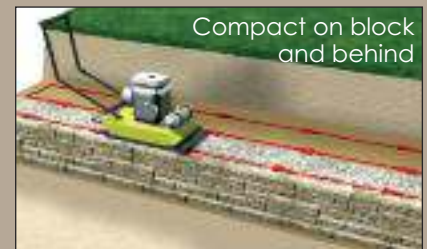

Compact on block and behind



Install next layer of geogrid



Install next section of pattern

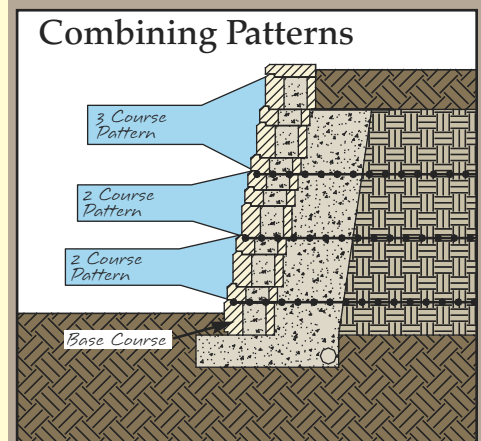

# Patterned Walls Cont.

## Tips for Building Patterned Walls

Patterned walls resemble hand-laid stone walls, and will require a certain level of detail and craftsmanship to construct. Some custom fitting of blocks will be required. Plan on taking a little extra time to build, particularly when building one for the first time.

## Ending Patterned Walls

Patterned walls may be ended with step-down or turn-ins. When ending a patterned wall you will need to modify the pattern and randomly adjust as necessary to create the look desired.

## Curves

When building curves, the 2 course pattern is easier to work with than the 3 course pattern. To build tighter inside or outside curves see page 33.

## Additional Construction Tips

- When building an AB Ashlar Blend or an AB Aztec Blend wall, if an AB Junior Lite or AB Aztec Jr Lite block is not available, the AB Lite Stones or AB Aztec Lite Stones must be cut to produce 2 AB Half Lites. Pre-cut the desired number of blocks to help speed installation.
- Offset each new pattern from the pattern below to maintain the "random" appearance.
- With walls that have numerous inside and outside curves, use a 2 course pattern to ease the installation process.

## Wall Patterns

The AB Collection, AB Aztec Collection and the AB Europa Collection can be used to create a variety of pre-set and random patterns. A pre-set pattern is repeated every two or three courses of block. A single course consists of a full size block, approximately 8 in. (200 mm) high. Random patterns used on a reinforced wall require a level surface every 2 courses for proper installation of geogrid. Check your approved plans for geogrid placement.

**Note: Walls with curves should always use the 2 course pattern to minimize cutting and fitting. For walls requiring geogrid use the 2 course pattern to allow for proper geogrid placement.**

## Ending Patterned Walls



## Cutting A Block In Half

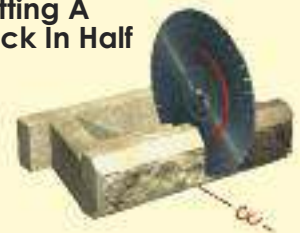

## Standard Patterns - Uses all blocks in the collection.

Patterns are 10 ft. sections (3 m)



AB Europa Collection	AB Collection	AB Aztec Collection
6 AB Dover	6 AB Classic	6 AB Aztec Classic
4 AB Palermo	4 AB Jumbo Jr.	4 AB Aztec Jr.
8 AB Barcelona	8 AB Lite Stone	8 AB Aztec Lite Stone
8 AB Bordeaux	8 AB Jr. Lite*	8 AB Aztec Jr. Lite*



AB Europa Collection	AB Collection	AB Aztec Collection
10 AB Dover	10 AB Classic	10 AB Aztec Classic
10 AB Palermo	10 AB Jumbo Jr.	10 AB Aztec Jr.
10 AB Barcelona	10 AB Lite Stone	10 AB Aztec Lite Stone
4 AB Bordeaux	4 AB Jr. Lite*	4 AB Aztec Jr. Lite*

\* Use an AB Lite Stone or AB Aztec Lite Stone cut in half to create an AB Half Lite if AB Jr. Lite or AB Aztec Jr. Lite is not available.

## Lite Patterns - Uses the small blocks in the collection.

Patterns are 10 ft. sections (3 m)



AB Europa Collection	AB Collection	AB Aztec Collection
7 AB Palermo	7 AB Jumbo Jr.	7 AB Aztec Jr.
15 AB Barcelona	15 AB Lite Stone	15 AB Aztec Lite Stone
12 AB Bordeaux	12 AB Jr. Lite*	12 AB Aztec Jr. Lite*



AB Europa Collection	AB Collection	AB Aztec Collection
14 AB Palermo	14 AB Jumbo Jr.	14 AB Aztec Jr.
19 AB Barcelona	19 AB Lite Stone	19 AB Aztec Lite Stone
18 AB Bordeaux	18 AB Junior Lite*	18 AB Aztec Jr. Lite*

\* Use an AB Lite Stone or AB Aztec Lite Stone cut in half to create an AB Half Lite if AB Jr. Lite or AB Aztec Jr. Lite is not available.

**Note: Maximum recommended gravity wall height for Lite Patterns is 3 ft (0.9 m).**

**Note: A base course of full size blocks (AB Classic or AB Dover) needs to be included. For each 10 ft. (3.0 m) of wall length you will need 7 full size blocks. For 10 ft. (3.0 m) of wall length for AB Capstones, you will need 7 AB Caps.**



allanblock.com

# AB Fieldstone



## Green, Natural and Friendly.

Facing Series: Cascade  
Color: Rustic Creek

### Install Base Course

- Refer to page 22 for complete details and proper steps for base preparation and installing the base material.
- **Begin at the lowest wall elevation** by placing the AB Fieldstone facing units on the base material towards the front of the trench, leaving room for the AB Fieldstone anchoring unit. When anchoring unit is installed the block assembly is in the center of the trench. Check each unit and adjust for level and alignment. The facing units can be randomly flipped upside down to give different facing appearances.
- For proper placement of the anchoring units, use a brick hammer or shovel to create a small trench to allow for the lip.
- Install the anchoring units into the receiving slots of the facing units with the lip facing down in the trench just created. Make adjustments to ensure anchoring units are installed reasonably level with the facing unit. **The anchoring units should never be installed higher than the facing unit.** Except for special applications like corners, each anchoring unit should match up with one facing unit.
- A drain pipe is required for any reinforced wall, gravity walls over 4 ft. (1.2 m) tall or sites with poor drainage. Place the drain pipe at the lowest possible point toward the back of the trench and vent to daylight every 50 ft. (15 m). See approved plans for location and specifications. See page 19 for more information.

### Install Wall Rock and Backfill Materials

- Fill the hollow cores and a minimum of 12 in. (300 mm) behind the wall with wall rock. Install the wall rock to be level or below the receiving notch of the anchoring unit.
- Use approved soils to backfill behind the wall rock and in front of the base course.
- Use a plate compactor to consolidate the area behind the blocks.
- **Compact in lifts of 8 in. (200 mm) or less.**

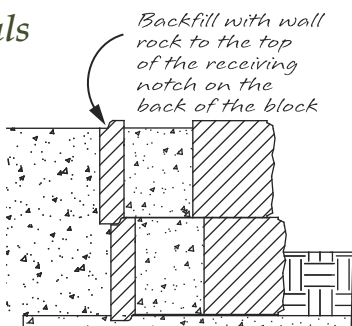

Install facing unit



Level and align



Install anchoring units



Backfill and compact

Visit [allanblock.com](http://allanblock.com) for more information.

## Install Additional Courses

- Remove all excess material from the top surface of the AB Fieldstone units. This should include running a brush or broom across the receiving slot to remove any debris.
- If reinforcement is needed, check your approved plans for exact size and course location. Refer to page 24 for complete AB Reinforcement Grid installation.
- For faster installation and alignment of the second course, install the first AB Fieldstone facing unit and AB Fieldstone anchoring unit at the same time. Make adjustments so that the vertical seams are offset from the blocks below by at least 3 in. (75 mm) or  $\frac{1}{4}$  the length of block.
- Install the rest of the facing units using the first block as a placement guide.
- Place anchoring units into the receiving slots of the facing units. Slide the two-piece assembly so that the lip of the anchoring unit is placed into the receiving slot of the block on the course below. **Each anchoring unit should match up with one facing unit.**
- Check and adjust for level and alignment of the facing units.
- Fill the hollow cores and a minimum of 12 in. (300 mm) behind the wall with wall rock. Install the wall rock behind the anchoring unit to be level or below the receiving slot or approximately 0.5 in. (12 mm) below the top of the anchoring unit.
- Use approved soils to backfill behind the wall rock.
- **From course 2 and above use a plate compactor to compact directly on the blocks as well as the area behind the blocks. Compact in lifts of 8 in. (200 mm) or less.**
- Remove excess material from the top surface and repeat steps to complete the wall to the height required. See page 54 for information on ending walls with turn-ins.

## Finishing an AB Fieldstone Wall

Filter fabric is used on top of the top course of blocks and below the caps to cover the back of the AB Fieldstone anchoring units. This will allow plantable soil to be placed flush against the cap unit.

- Place a strip of filter fabric along the top of the AB Fieldstone anchoring units on the top course of wall. Position so that the fabric starts at the back of the AB Fieldstone facing unit and goes over the AB Fieldstone anchoring unit and down along the back of the anchoring unit.
- Be sure to leave the top surface of the facing unit exposed so that the cap sealant can be placed on the facing unit.
- Finish the wall with AB Capstones. Place the first capstone on the wall to include a 1.5 - 2 in. (40 - 50 mm) overhang.
- Run a string line the length of wall to mark placement of additional capstones. To get a consistent point, use the 45° chamfers at the end of each cap as alignment points for string line.
- Use a flexible masonry adhesive, NP1 or equivalent, to secure the capstones in place. Put a small bead of sealant along the sides of the caps as well.
- Backfill behind the last course and behind the AB Capstone with impermeable fill to allow for planting up to the back of the wall.

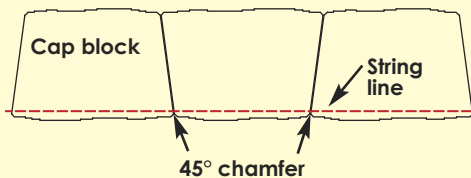

**Note:** To help hold the filter fabric in place while backfilling, place a spot of sealant between the fabric and the anchoring unit.

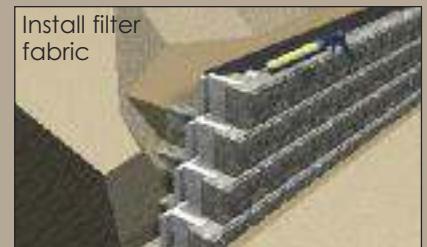
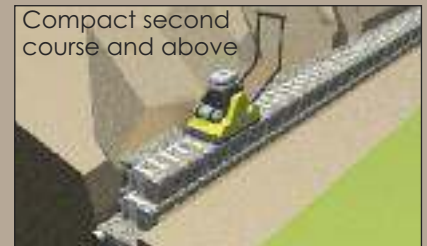



## AB Fieldstone Anchoring Units

AB Fieldstone is a multi-piece retaining wall system where each block assembly consists of a facing unit and an anchoring unit. These universal anchoring units, short anchoring unit (SAU) and long anchoring unit (LAU), are made of recycled materials and are used with the 812 and 824 facing units.

See page 12 for the Maximum Gravity Wall Height Chart.



## What Makes Retaining Walls Work

Retaining walls are typically built and used to hold back soil for many different types of applications. The size of the actual retaining wall unit is important. With a larger block footprint a taller gravity wall can be built that can safely retain the pressure from the soil behind it. The short anchoring unit (SAU) with either facing unit develops a block assembly that is approximately 13 inches (325 mm) deep. The long anchoring unit (LAU) with either facing unit develops a block assembly that is approximately 24 inches (600 mm) deep. Use the following general guidelines to determine which anchoring unit is most appropriate.

Facing unit (812 & 824)  
with short anchoring  
unit (SAU).



All anchoring units  
are made of recycled  
materials.

Facing unit (812 & 824)  
with long anchoring  
unit (LAU).



The **short anchoring unit (SAU)** is used for lower height gravity walls and reinforced walls. Walls taller than those listed in the Maximum Gravity Wall Heights Chart on page 12 will need geogrid reinforcement for additional stability. Refer to page 24 for general reinforcement requirements and instructions.

The **long anchoring unit (LAU)** may provide the solution for projects that require taller gravity wall heights where space is limited behind the wall by property lines, right of way issues, underground utilities or existing structures.

For walls over 4 ft. (1.2 m) in height, terraced applications, or slopes below the wall you will generally need to contact a local engineer for assistance in obtaining a permit prior to construction. Refer to the Maximum Gravity Wall Heights Chart on page 12 using your soil and site conditions to find the maximum height a wall can be built before reinforcement will be needed.

# Curved Walls



allanblock.com

*Flowing curves accent any landscape.*

AB Collection

## Building Curves

Curved and serpentine walls are simple to build. Allan Block's patented design allows for easy installation of both inside and outside curves. **Most curves can be built with no cutting involved.** For walls requiring geogrid, see page 36.

- Try to maintain an offset of the vertical seams by at least  $\frac{1}{4}$  of the block length from the courses below for both inside and outside curves. Cutting a block in half or using the half width blocks - AB Jumbo Jr. from the AB Collection, AB Aztec Jr. from the AB Aztec Collection or AB Palermo from the AB Europa Collection, will assist in creating a proper offset.
- Before constructing your wall, layout the design using a garden hose or paint. Measure the radius of each curve and refer to the radius chart. Select blocks that will fit your design or adjust your design to fit the blocks you have selected. As a rule, gentle sweeping curves produce more aesthetically pleasing walls.

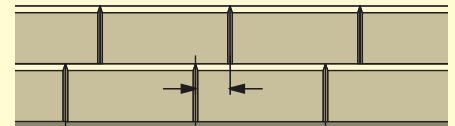

Offset by at least  $\frac{1}{4}$  of the block

## Inside Curves

- To build a flowing inside curve, keep the front of the blocks tight together and fan out the blocks keeping the space consistent between the backs of the blocks.



Inside Curve

## Outside Curves

- To build smooth outside curves, remove one or both of the "wings" from the back of the blocks and tighten the radius of the curve. To obtain a clean break, hit the back of the wings with a hammer or for the AB Fieldstone anchoring units, use a hammer and chisel in the existing score line.

AB, AB Aztec or AB Europa Collection blocks



Remove wings for outside curves

Outside Curve



Remove wings for outside curves

AB Fieldstone anchoring units

## Note:

An AB Fieldstone 812 assembly is recommended for building curved walls. The 824 assembly will work in large gradual curves only.



## Determining the Radius

- The tightest or smallest radius at the top of the wall is:  
 For the **AB, AB Aztec or AB Europa Collection**  
 Full size block is 4 ft. (1.2 m), half width block is 2.5 ft. (0.8 m).  
 For the **AB Fieldstone Collection**  
 The 812 assembly with a short anchoring unit is 5.25 ft. (1.6 m).
- Curved walls have a greater setback, which causes a coning effect to occur; which in turn creates the need for a larger radius at the base course. The final height of the wall will determine what the minimum radius at the base course must be. Use the **Radius Chart** to determine what the minimum recommended radius of the base course of the wall needs to be, so the top course of the wall will not be less than 4 ft. (1.2 m).

## Starting the Curve

From the point of where the curve will start, measure straight back from the wall the required amount (shown in the Radius Chart) and drive a stake into the ground. This will be the center of the curve. Attach a string line to the stake the length of the radius and rotate it around to mark the location of the base course. Install the blocks with the front of the blocks lining up with the mark.

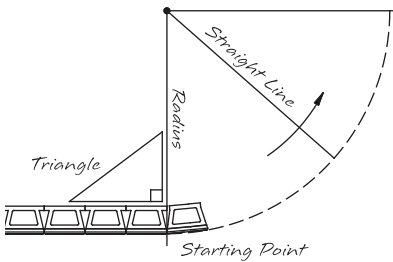

Attach a string line to the stake the length of the radius and rotate it around to mark the location of the base course. Install the blocks with the front of the blocks lining up with the mark.

- To transition the curve back into a straight wall or another curve, lay out the curve and the first couple blocks of the next section. Adjusting 1 or 2 of the blocks will help in the transition of the next section of wall.



AB Fieldstone Collection  
Facing Series: Cascade  
Color: Rustic Creek

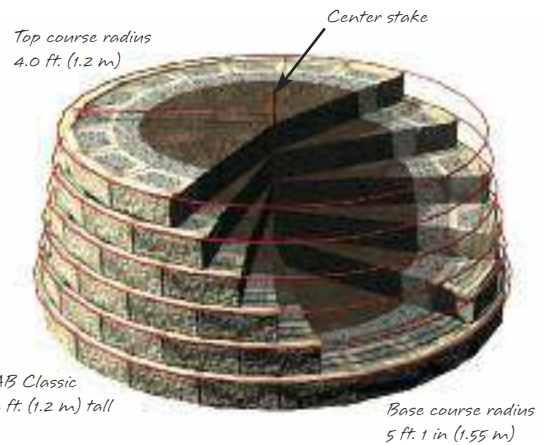

Table 7

AB Radius Chart for Base Course				
Setback	Wall Height			
	3 ft 0.9 m	4 ft 1.2 m	5 ft 1.5 m	6 ft 1.8 m
AB Stones 12° (Ref)	5 ft. 3 in.	5 ft. 6 in.	5 ft. 9 in.	6.0 ft.
	1.6 m	1.7 m	1.75 m	1.8 m
Radii listed are for reference only.				
AB Classic, AB Life Stone, AB Aztec Classic, AB Aztec Lite Stone, AB Dover and AB Barcelona, 6° (Ref)	4 ft. 11 in.	5 ft. 1 in.	5 ft. 4 in.	5 ft. 6 in.
	1.5 m	1.55 m	1.62 m	1.7 m
Radii listed are for reference only.				
AB Fieldstone w/short anchoring unit (SAU) 6° (Ref)	6 ft. 5 in.	6 ft. 7 in.	6 ft. 10 in.	7.0 ft.
	1.95 m	2.0 m	2.1 m	2.13 m
Radii listed are for reference only.				
AB Jumbo Jr., AB Jr Lite, AB Aztec Jr, AB Aztec Jr. Lite, AB Palermo, and AB Bordeaux 6° (Ref)	3 ft. 5 in.	3 ft. 10 in.	4 ft. 3 in.	4 ft. 7 in.
	1.0 m	1.16 m	1.28 m	1.40 m
Radii listed are for reference only.				

Use this chart to find the minimum recommended radius at base of the wall. The AB Fieldstone 824 units are to be used in straight walls or gradual curves only. Note all radius lengths, dimensions and setbacks are approximate.

## Building Tighter Curves with the AB, AB Aztec or AB Europa Collection

- Use the AB Jumbo Jr, AB Aztec Jr or the AB Palermo whenever possible to build tighter curves within the wall.
- When using full size blocks, it may be necessary to remove parts of the bottom notch to fit the blocks closer together.

### Cutting The Bottom Notch For Tighter Inside Curves

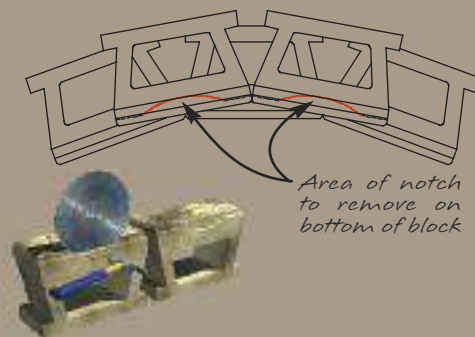

### Cutting The Bottom Notch For Tighter Outside Curves

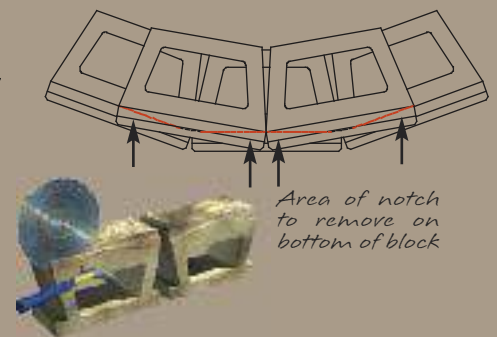

# Corners



allanblock.com

*Gain usable space  
and create new  
living areas.*

AB Europa Collection  
AB Abbey Blend Pattern

## *AB, AB Aztec or AB Europa Collection Corners*

Whenever possible we recommend using curves instead of corners for a smooth flowing look to your landscape. Our example uses an AB Jumbo Jr, but can be used with any block.

### *Inside Corners*

Standard blocks are easily modified to build inside corners. You will need a concrete saw with a masonry blade to make the necessary cuts (a good chisel will work too).

- Using your saw or chisel, remove the raised lip from one block, and 1/3 from the left side of another. Set them in place at the beginning of the base course.
- Locate the adjoining wall so that the raised lip on the modified block is lined up with the raised lips on the opposite wall. Finish installing the entire base course in both directions.
- Modify two more blocks, this time remove the raised lip from one block, and the right third from another. Use these blocks to start the second course.
- Continue the process to the top of the wall, alternating as you go.
- Cut caps at 45 degree angles to complete the inside corner and give the wall a custom finished look.

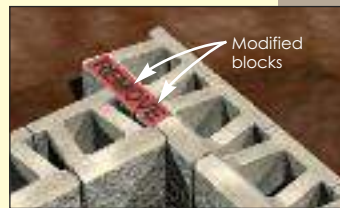

### *Outside Corners*

AB Corner Blocks are all you need to make an outside corner. Always build your walls by starting at the corners and working out. AB Corner Blocks are manufactured with a 12° (Ref) setback. With some minor adjustments, the blocks can work with any setback. See AB Tech Sheet #298 at allanblock.com for more details.

- Set the first corner block in place and install the two perpendicular base courses. Level, backfill and compact.
- Place an alternating corner block on the second course and set the entire second course of block in both directions. Level, backfill and compact again.
- Repeat as often as needed to the top of the wall.
- Cut caps at 45 degree angles to complete the outside corner and give the wall a custom finished look.



## Corners with the AB Fieldstone Collection

### Inside Corners

By alternating the block's placement on each course of the wall, an inside corner can be installed. The 824 facing units are ideal for this task, but 812 facing units are acceptable. For walls requiring geogrid, see page 24.

- To create a 90° inside corner, begin by placing an AB Fieldstone facing unit (A) at the corner. Then lay a second facing unit (B) perpendicular to the first. This second unit (B) must extend past the back of the first facing unit (A). Continue laying out the rest of the base course working from the corner out in both directions. Install the anchoring units.
- On additional courses alternate the placement of the facing units. Remove the lip from the anchoring unit, where the anchoring unit sits on the facing unit below as needed.
- Cut caps at 45 degree angles to complete the inside corner and give the wall a custom finished look.

### Outside Corners

Some of the AB Fieldstone facing units are manufactured with a textured side that compliments the facing unit. Besides being used as a standard block, these blocks can be used to create a corner. To create a left or right hand corner simply flip the facing unit as needed to change the direction. For walls requiring geogrid, see page 24.



Inside and Outside Corner

- Whenever possible, begin your wall at the corner. Install a corner facing unit with the textured end facing out at the corner. Install an additional facing unit perpendicular to create a corner. Install a bead of flexible concrete adhesive between them to hold in place during construction (optional). Install additional facing units in both directions to continue down the wall. Check for level. (Step 1)
- Starting at the corner and working out in both directions, use anchoring units to span the first two facing units in each direction. (Step 2) Both of these anchoring units will need to be modified slightly. On the base course and above remove the wing from one anchoring unit. From course two and above, remove part of the lip off the other anchoring unit so that it fits on top of the course below. (Step 3) See page 49 for information on modifying an anchoring unit.
- Use half of an anchoring unit on either side of the spanning anchoring units to get pattern back to each facing unit having its own anchoring unit. (Step 4)
- Align the lip and notch of the anchoring units in each direction to ensure proper placement of next wall course.
- Cut caps at 45 degree angles to complete the outside corner and give the wall a custom finished look.

### Inside Corners

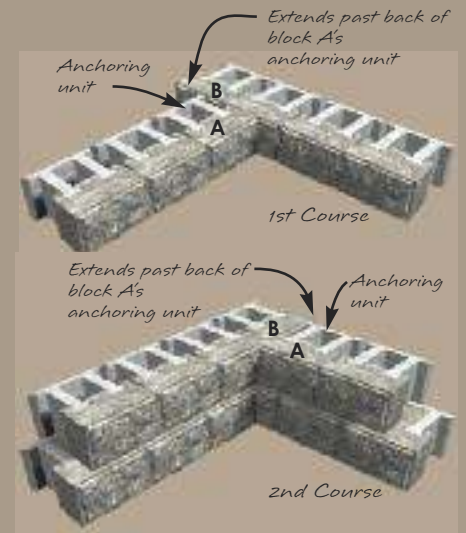

### Outside Corners

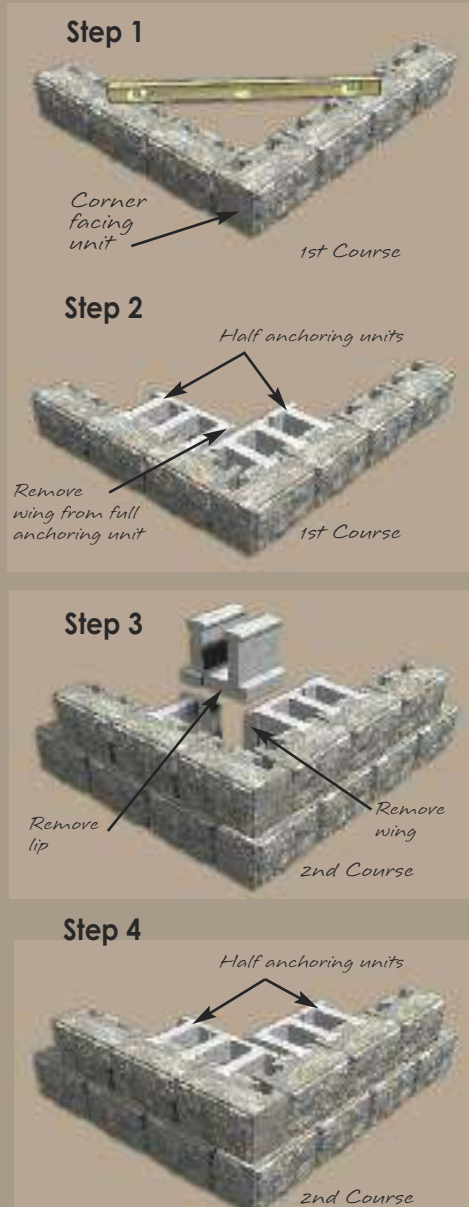

# Curves with Geogrid



allanblock.com

*Gentle sweeping curves create aesthetically pleasing walls.*

AB Collection

## Working with Inside Curves and Geogrid

Geogrid needs to have 100% coverage around any curve. To achieve this, additional layers need to be installed above the course where the geogrid is required to fill voids that are created.

- Roll out the AB Reinforcement Grid behind the wall, keeping the edge of the geogrid tight against the front of the blocks. Voids will appear between the pieces at the back. Trim the geogrid to fit along the front lip of the blocks.
- Mark the blocks or take note of the areas where the voids are in the geogrid placement.
- On the next course of block, **place geogrid over the marked areas covering the voids.**
- On patterned walls, fit the grid through the coursing as best as possible to fill the void from the course below.

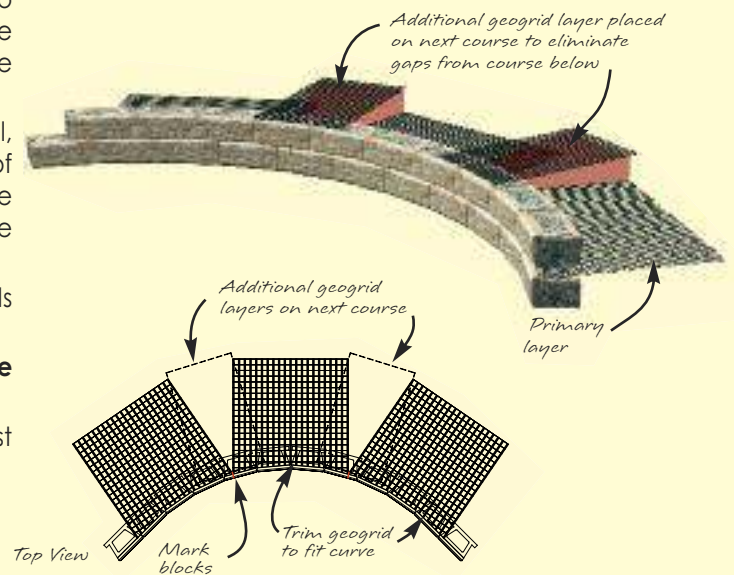

## Working with Outside Curves and Geogrid

- Roll out the AB Reinforcement Grid around the curve. Trim to fit along the front lip of the blocks.
- Lift the section of geogrid that overlaps and place infill material to separate. Geogrid layers need to be separated by a 3 in. (75 mm) layer of infill or approved on-site soils.
- **Never compact directly on the geogrid.**
- Geogrid must cover the entire curved area.

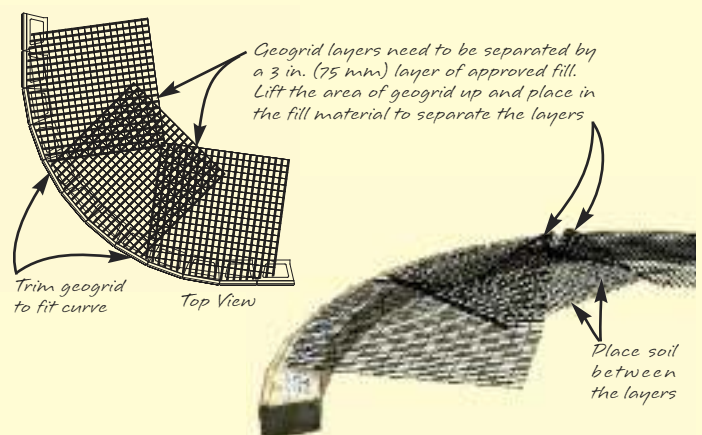

# Corners with Geogrid

## Installing Geogrid on Inside 90° Corners

On inside corners additional geogrid is required to extend past the end of the wall 25% of the completed wall height.

- Roll out the AB Reinforcement Grid behind the blocks, keeping the edge of the geogrid tight against the front lip of the blocks. Extend the geogrid past the inside corner by at least 25% of the wall height in one direction.
- On the next course of block where geogrid is required extend the geogrid past the inside corner in the opposite direction. Never place geogrid directly on top of another layer of geogrid.

### EXAMPLE:

Finished wall height is 6 ft. (1.8 m), divide by 4 which equals 1.5 ft. (0.45 m).

The length the geogrid will need to extend past the corner is 1.5 ft. (0.45 m).

## Installing Geogrid on Outside 90° Corners

Each side of the corner must be reinforced independently from each other.

- Roll out the AB Reinforcement Grid to the outside corner in one direction. Never place geogrid directly on top of another layer of geogrid.
- On the next course of block where geogrid is required, lay the next layer of geogrid perpendicular to the previous layer. Using AB Reinforcement Grid you will not need a layer of geogrid on every course due to its bi-axial strength.

For more information on corner construction see page 34.



## Geogrid with Inside 90° Corners

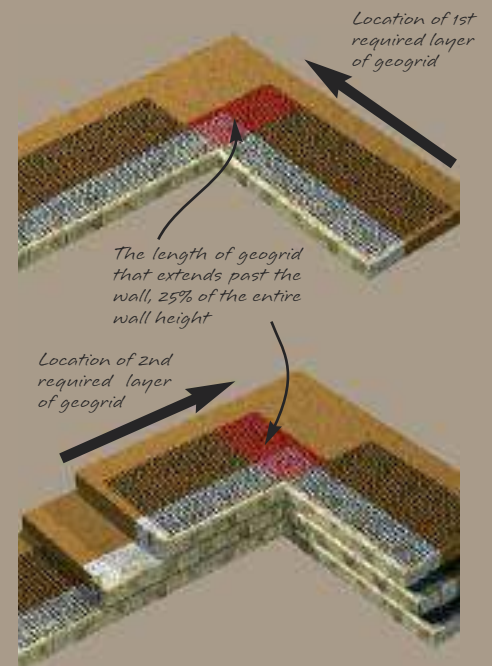

## Geogrid with Outside 90° Corners

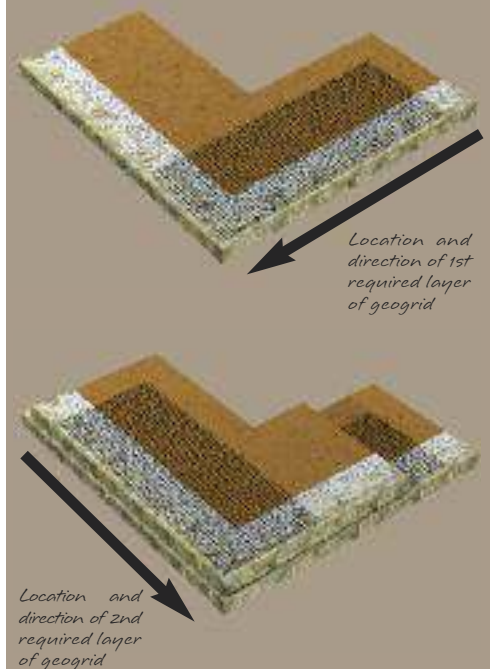

# Stepping up the Base



allanblock.com



AB Collection

**Allan Block walls are versatile with proven performance.**

## Building Step-Ups into the Slope

- When building step-ups, begin the base course at the lowest wall elevation.
- Dig a base trench that is 24 in. (600 mm) wide.\*\*
- The depth of the trench is determined by allowing for 6 in. (150 mm) plus an additional 1 in. (25 mm) for each 1 ft. (300 mm) of wall height for the amount of buried block that is needed. The trench also needs to extend into the slope far enough to bury one full block.\*\*
- If a slope is present below the wall, contact a local engineer for assistance.
- Compact and level the base trench making a minimum of 2 passes with a plate compactor.
- Place the drain pipe at the lowest possible point toward the back of the trench.
- Place a minimum of 6 in. (150 mm) of wall rock in the base trench and check for level. Compact the base material, making a minimum of two passes with a plate compactor.
- Excavate the second step-up making sure to accommodate for the base material and buried block. Compact and level the step-up area.
- Place the base course of blocks on the base material and check for level.
- Fill the hollow cores and 12 in. (300 mm) behind the block as well as the base area of the next step up with wall rock then backfill with infill or approved on-site soils. **Make sure that the blocks and the base of the next step-up are level.**
- Compact the wall rock directly behind the block and the next step up area a minimum of two passes with a plate compactor.
- Repeat these steps to the top of the grade.
- Keep in mind the block at each step-up must be completely buried to maintain the proper base depth and to prevent wall failure due to erosion.

\*\* For walls under 4 ft. (1.2 m) dig the base trench 18 in. wide (460 mm) and 4 in. deep (100 mm) plus additional to account for the amount of buried block needed.

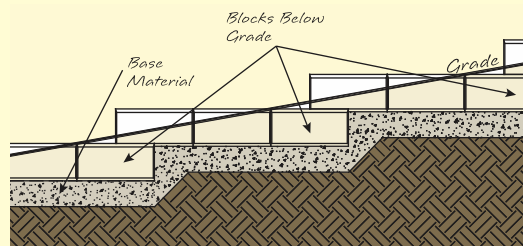



## Building Step-Ups with AB Fieldstone 824 Assembly

Step-ups are most stable when the upper block has sufficient bearing on the lower block. The length of the 824 assembly (if available) provides the flexibility to make this block ideal for this application. If using the 812 assembly, see page 38.

- Build the wall up to the step-up location. Excavate for next step up.
- Install wall rock, level and compact. Compaction of the base material where the step-up will be installed is very important to ensure the wall does not settle. Make a minimum of 2 passes with a plate compactor.
- Create the step-up by placing an AB Fieldstone 824 assembly so it is installed on at least 6 in. (150 mm) of the block below and spans out onto the base material creating the next course. Install an AB Fieldstone 812 assembly next to the 824 assembly to complete the step up.

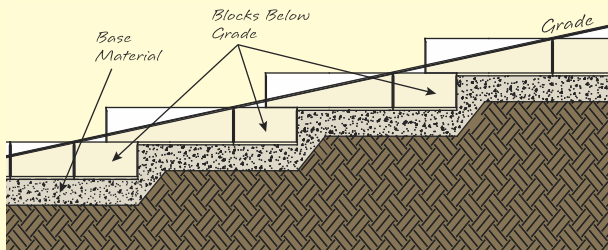

- Fill the hollow cores and 12 in. (300 mm) behind the block as well as the base area of the next step up with wall rock then backfill with infill or approved on-site soils. **Make sure that the blocks and the base of the next step-up are level.**
- Compact the wall rock directly behind the block and the next step up area a minimum of two passes with a plate compactor.
- Repeat these steps to the top of the grade.
- Keep in mind the block at each step-up must be completely buried to maintain the proper base depth and to prevent wall failure due to erosion.

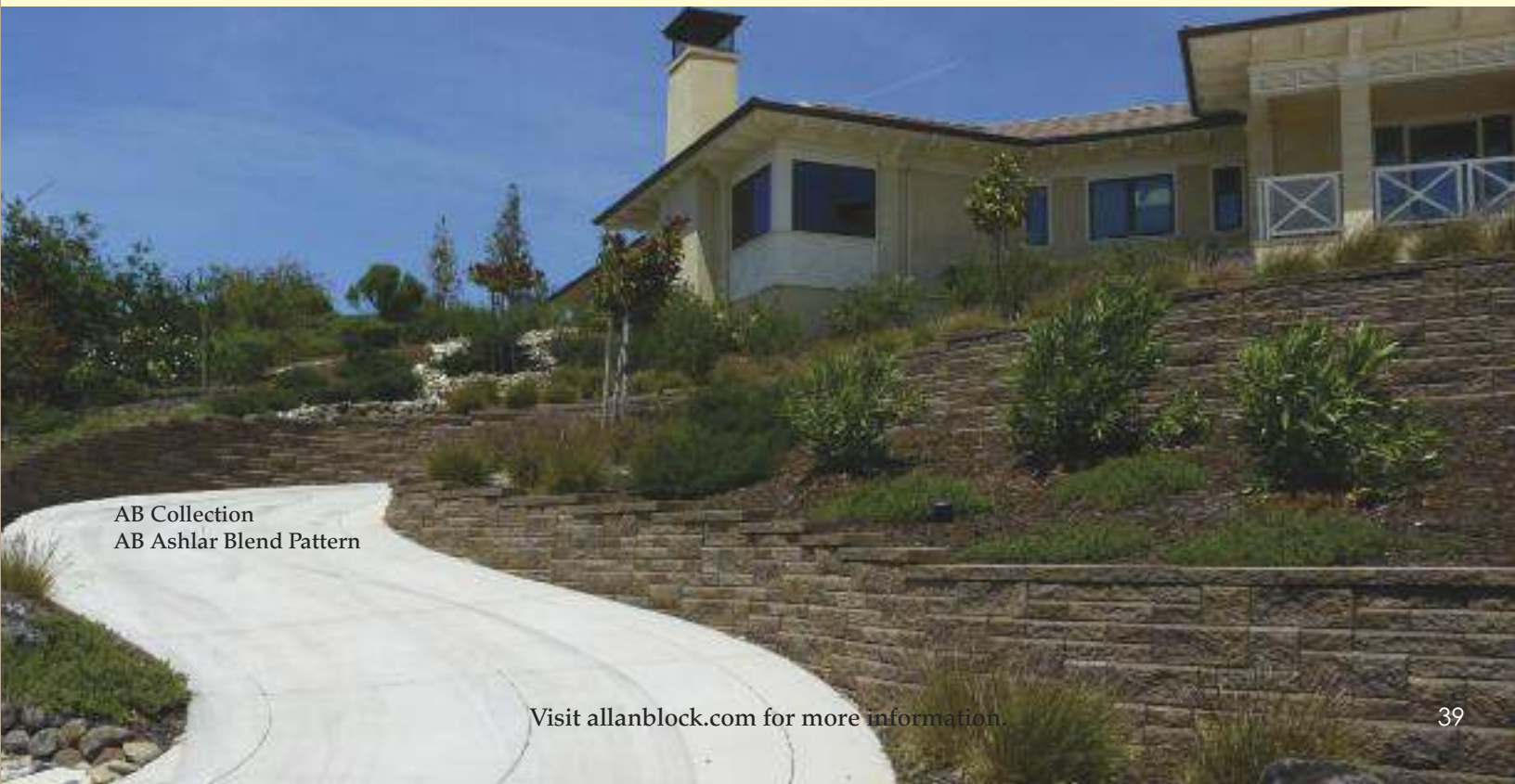

# Stairways



allanblock.com

## Plan, design and build steps into your wall.

AB Europa Collection

### Allan Block Wall Systems offer a variety of options for stairways.

Stairs can be designed with flowing curves or straight lines. Curved sidewalls create a softer, natural look. Straight sidewalls and corners offer a crisp, traditional style; however they require AB Corner Blocks and take more time and custom cutting to build.

### How Many Steps?

To find the number of steps needed, measure the total rise of your slope in inches and divide by 8 in. (200 mm) - the approximate height of a block.\*

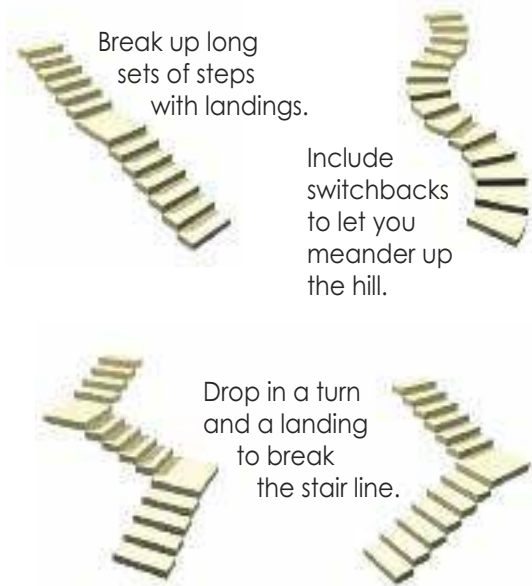
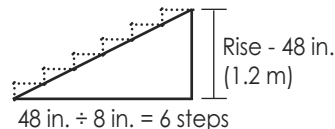

\* Check with your local Allan Block Dealer for exact specifications



AB Collection

### Tackle Your Slope

Match your stairway design to the natural grade of your slope.

- On steep slopes, keep the blocks tight together. With Allan Block, you get an 8 in. rise and a 12 in. run. (200 mm rise and a 300 mm run).\*
- On gentle slopes, add pavers or other materials to increase the depth of the tread and length of the run.
- Landings can soften a long stairway and provide an easy way to tie sets of steps together.

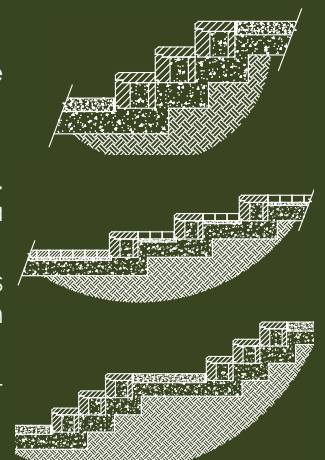

## Take Time to Build In Quality

Building stairs and steps requires careful planning, flexibility on the job site and an eye for detail. Be sure to allow adequate time for layout and building of stairs.

### Determine Stair Riser Locations

Once the number of steps has been determined and the type of stair tread has been selected, excavate the stair location based on the rise and run.

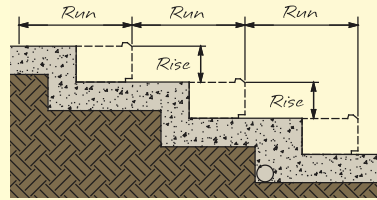

- Mark the center of the stairway where the base stair riser will be placed. In this example the first stair riser is the continuation of the base course of the wall that the stairs are being built into.
- Each stair riser will need a minimum of 6 in. (150 mm) of base material under it that extends a minimum of 6 in. (150 mm) behind the AB block.
- **Make adjustment as needed so that the finished height of the first riser is not more than 8 in. (200 mm) high with stair tread material and final grading in place.**

### Excavate the Base Trench and Stair Location

- From the base stair riser location mark the remainder of the stair risers and remove the soil to meet the base material requirements. If more soil was removed than necessary during excavation, replace it with wall rock during the building process. Any excavated soils that are replaced will need to be properly compacted. **If organic or wet soils are present in the base trench they must be removed and replaced with granular material.**
- After the stair location has been excavated, you will prepare your base and base course just like any other wall. Use the information on page 22 to dig a base trench to the appropriate size.
- Compact the base trench making a minimum of two passes with a plate compactor.
- If a drain pipe is required in your project, continue the placement of the pipe in the trench for the base course. See page 22 for more information on placement.
- Place a minimum of 6 in. (150 mm) of wall rock in the base trench and rake smooth.
- Compact the wall rock making a minimum of two passes with a plate compactor.
- Check for level, and adjust as needed. See page 22 for more information.

### Install the Base Course

- Place the blocks with the raised front lip facing up and in the center of the trench.
- Check each block for level from side-to-side and front-to-back. Verify the proper position of the base course by examining a string line across the back of the blocks. Make adjustments as necessary.
- Fill in the area in front of the blocks with on-site soils. This will keep the base course blocks from shifting while filling and compacting.
- Fill the hollow cores and at least 12 in. (300 mm) behind the blocks or more to accommodate the next stair riser with wall rock.



### Always check local code requirements before building any type of stair application.

The steps shown here are general guidelines for building stairways. By understanding the basic installation elements, stairways can be easily incorporated into the wall installation.



Visit [allanblock.com](http://allanblock.com) for more information.

### Salt for Ice Removal

In northern climates the use of salt on stair tread materials made of concrete is NOT recommended as the salt will cause the block to deteriorate. Use sand instead.

### Drain Pipe

If drain pipe is being used on your project, continue it behind the stairs at the lowest point of elevation. Do not interrupt the drain pipe at stair locations.

# Stairways Cont.

- Use infill or approved on-site soils to fill in any additional areas behind the wall rock. The stair tread area must be level with the top of the base course of blocks.
- Use a plate compactor to compact the wall rock starting directly behind the block and working in a path parallel to the wall, working from the back of the block, over the stair tread area, to the back of the excavated area. Always compact in 8 in. (200 mm) lifts or less. See page 21 for details on compaction.

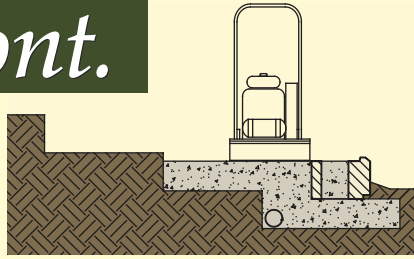

## Install First Stair Riser

- Measure the distance for the placement of the first stair riser making sure that the blocks are parallel with the base course in front. Place the blocks on top of the compacted stair tread area making sure to allow for 6 in. (150 mm) of wall rock behind the blocks.
- To ensure the blocks will be level with the corresponding wall, place a block on the wall as a reference point and level from that block to the blocks being used for the stair treads.
- Level and adjust as necessary.
- To curve the wall out from the stair location, break the wings off the backs of the blocks and place them tight together, following the layout on your approved plans.

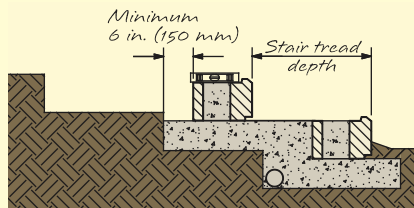

## Backfill and Compact

- Fill in the area in front of the first stair riser with a small amount of wall rock. This will keep the blocks from shifting while filling and compacting.
- Fill the hollow cores and at least 12 in. (300 mm) behind the blocks or enough to accommodate the next stair riser with wall rock.
- Then compact and level the wall rock as previously done.



## Additional Steps

- Repeat these steps for each stair riser.
- Once all the steps are in place, install the selected stair tread material to finish your stairway.

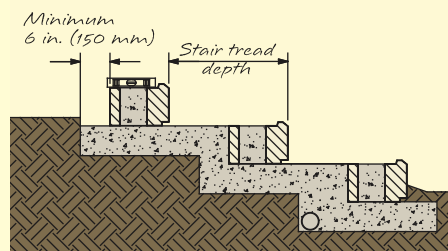

## Stair Tread Options

- Allan Blocks patented front lip provides a built-in edging that works well with AB Capstones, pavers and poured concrete.
- When using a rigid dimension tread material such as AB Capstones or pavers, carefully plan the stair dimensions to reduce the amount of cutting required. Ensure stair treads are secured in place with a high strength flexible masonry adhesive for safe use.

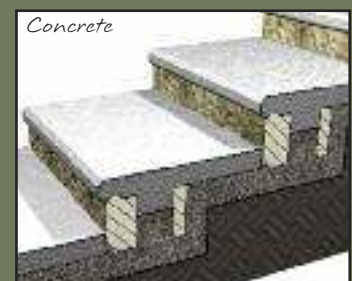

## Stair Applications

Additional stair designs and technical information explaining the construction process is available on our website at [allanblock.com](http://allanblock.com) or from your local Allan Block Dealer.

**Remember to always check the local building codes before construction.**



[allanblock.com](http://allanblock.com)



AB Collection

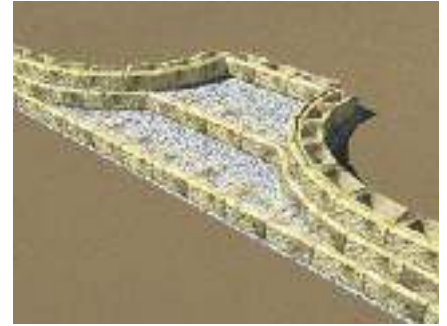

AB Europa Collection

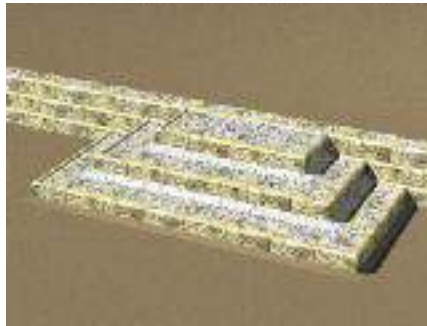

# Unlimited Design Options

AB Europa Collection  
AB Abbey Blend Pattern

Visit [allanblock.com](http://allanblock.com) for more information.

# In-Wall Planters/Terraces



allanblock.com

*In harmony  
with nature.*



AB Europa Collection  
AB Abbey Blend Pattern

## Design the Shape for Beauty and Function

Consider what will fill the space between terraced walls. Will it be used for plantings, filled with decorative rock or covered with sod? Terraced walls provide built-in edging that minimizes trimming and maintenance. Design the shape of terraced walls to compliment the surrounding architecture and landscape.

Landscape designs are often more attractive when they include smaller, terraced, or in-wall planters rather than one large wall. Terraced walls can create more usable space, build raised gardens, help prevent erosion and add interest to your landscape.



AB Collection  
AB Ashlar Blend Pattern

One  
Large Wall



In-Wall Planter

AB Collection  
AB Ashlar Blend Pattern



AB Collection  
AB Ashlar Blend Pattern

*Straight walls*  
create a formal,  
structured look.



*Flowing curves*  
have a more nat-  
ural feel, provide  
planting areas  
and create a  
softer look.

AB Collection

Irrigation is often included when incorporating a planter. Ensure that your plan includes provisions for water management.

## Always Build on Solid Ground

- The most important element in building terraces is soil compaction. Building on poor, uncompacted soil will result in settling of the upper walls. Although lower terraced walls are typically built on solid ground, upper walls are often built on soils that have been disturbed in the construction process. To ensure the stability of these soils, they should be removed down to solid ground and carefully reinstalled and compacted.

## Improper Compaction - Upper Wall Settles

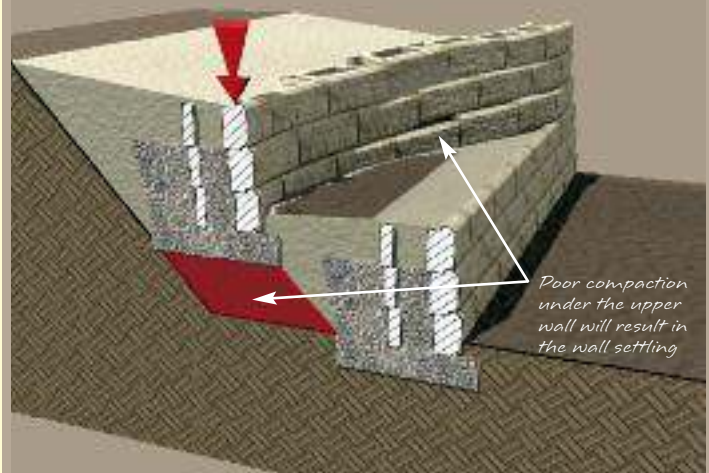

- To achieve proper compaction there are two different methods that work well. One way is to remove soft or poor soil and replace them with wall rock and compact in 8 in. (200 mm) lifts. Another way is to compact the soils in shorter lifts. When using infill or approved on-site soils, we recommend no more than a 4 in. (100 mm) lift. Good compaction is the key to minimizing settlement over time.

## Proper Compaction - Upper Wall Performs

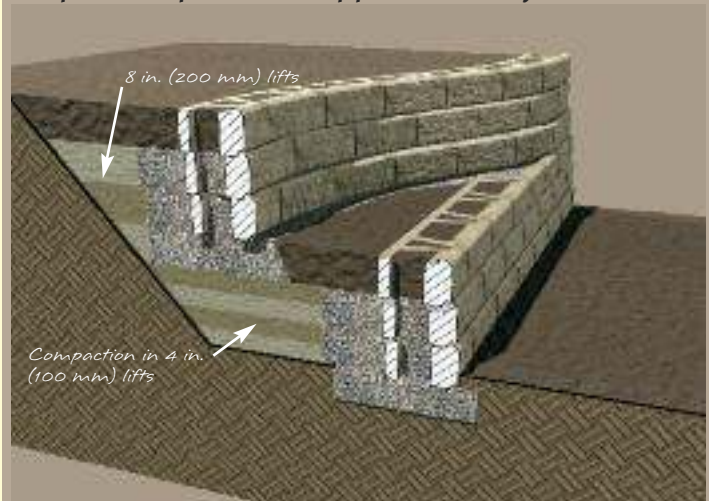

### Other areas that will require engineering are:

- Slopes above or below the walls
- Walls closer than 2 times the height of the lower wall
- Presence of ground water
- Surcharges
- Bad soils

## Terraces and Structure

Building a series of walls on a slope requires careful planning. Follow this simple set of rules:

When the walls are spaced far enough apart they are engineered as two independent walls.

- The height of the upper wall should be less than or equal to the height of the lower wall.
- The distance between the walls must be at least twice the height of the lower wall.

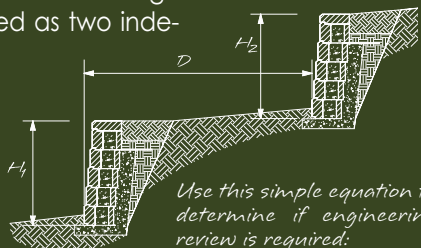

As the upper wall moves closer to the lower wall, it adds pressure (surcharge) to the lower wall.

The lower wall will need to be engineered to account for the added weight and pressure, and extra reinforcement may be required.

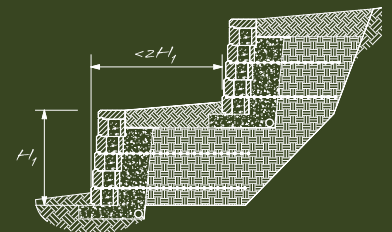

# Water Features



allanblock.com

*Beautiful landscapes made easy by design.*

AB Collection

## *Water in the Landscape*

### *Water Features Turn an Ordinary Landscape into a Peaceful Oasis*

They can provide a soothing retreat and a beautiful focal point within your overall landscape. Water features can attract birds and other wildlife. The sound of trickling water creates a place of quiet serenity and a sense of privacy.

### *Ponds and Fountains Bring the Landscape to Life*

Landscape water features can also be active and exciting, like a waterfall cascading over a natural rock formation. The sight and sounds of water-in-motion, flowing, spilling or cascading, can be a dramatic landscape enhancement. Splashing fountains... shimmering pools... no matter how simple or elaborate, water features can add a new dimension to your landscape.

### *Installation Notes*

- Flexible plastic liners provide built-in support for ponds.
- Plastic liners can be used for free-form ponds and water features. However, these features will transfer water pressure to the surrounding walls. Your retaining wall design must account for the added pressure.



AB Collection



AB Collection

## Pond with a Hard Liner

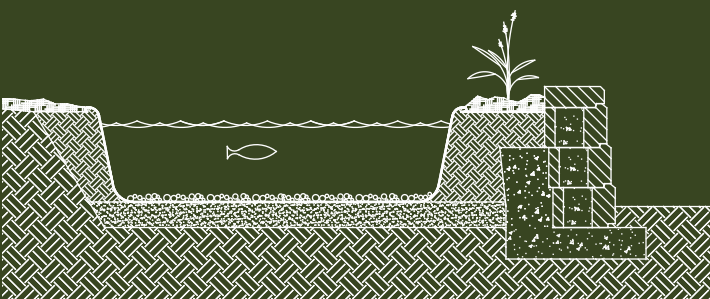

## Pond with a Soft Liner

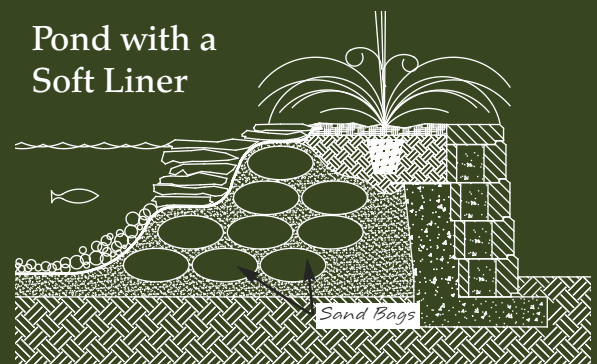

Sand Bags



# Lighting

*Accent your landscape with distinction.*



AB Europa Collection

## Lighting

### Lighting Adds a Dramatic Effect to Allan Block Walls

Lighting brings new possibilities to any landscape. Add a dramatic look with ground mounted lighting or illuminate stairways and pathways with recessed lighting. Allan Block walls with decorative lighting fixtures provide not only a distinctive design, but adds safety and security to the landscape.

Allan Block's hollow core design makes it easy to add lighting into any wall. Simply run the wiring directly behind the AB blocks (follow local electrical codes) to the light locations. Use a masonry saw to cut out sections of the block to accommodate the lighting fixture and run the wiring through the blocks out to the light fixture.

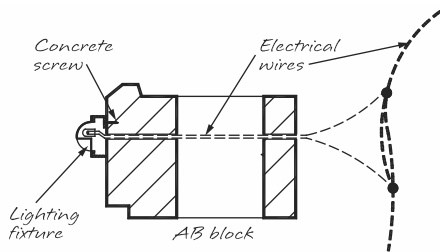

## Lighting Options



Cast a soft pool of light with a wall mounted light fixture.



Add soft general lighting with a recessed light fixture.

Illuminate pathways and garden accents with a pathway light fixture.

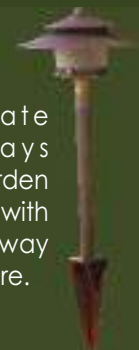

Silhouette accented landscape features with a bullet light fixture.



# Step Downs



allanblock.com

*End your wall with ease.*

AB Collection

## Stepping Down

One of the unique benefits that sets Allan Block apart from other wall systems is a great variety of options for ending and stepping down walls. With Allan Block, you can turn wall ends into the hillside with smooth flowing curves, corners or simple step downs. No other wall system gives you as many choices for finishing off your wall project.

For a gradual step down, use the half-high blocks - AB Lite Stone from the AB Collection, AB Aztec Lite Stone from the Aztec Collection or AB Barcelona from the AB Europa Collection.



For a full course step down, use the AB Corner Blocks from the AB, AB Aztec or AB Europa Collection or for AB Fieldstone see page 34 for details.



For a step down that doubles as a planter, turn the wall in 2 or 3 blocks after a corner.



Create a soft ending to the wall by using an inside curve while stepping down.



## Turn-ins

The simplest and easiest method of ending an Allan Block wall is to use smooth flowing curves that turn back into the hillside.

For a graceful, flowing end to the wall, curve the wall to create a plantable area that can soften the look of the wall.



For a natural flow into the landscape curve the wall back into the hillside.



### Tip:

The benefits of curving the wall back into the hillside include:

- less time & expense to build
- no corner blocks
- superior erosion control
- attractive design



### Tip:

Walls with ends that turn back into the hillside help prevent erosion behind the wall.

For a dramatic end to the wall, use a corner to turn the wall back into the hillside. See page 38 for information on stepping up the wall.

## Step Downs with AB Fieldstone

Creating a step down is similar to building an outside corner as it uses the same facing units that are manufactured with a textured side and has the same placement of the anchoring units.

- Install the facing units up to the step down location. Install the facing unit with the textured end perpendicular to create a corner, with the textured face placed to face out.
- Split an anchoring unit in half. Take one half and remove the bottom lip and place in the facing unit that was used to create the step down. See below for details on modifying an anchoring unit.
- The next anchoring unit will be installed in the first two facing units that lead up to the step down. **This anchoring unit will span two facing units.** One of the wings of this unit will need to be removed to allow placement.
- Use the other half of the previous anchoring unit in the next slot to get pattern back so each facing unit has its own anchoring unit.
- Use a flexible masonry adhesive to secure the corner units in place.



Modify half an anchoring unit by removing lip to secure the facing unit.

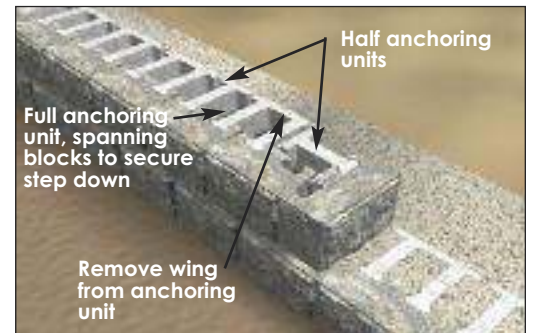

Install the half of an anchoring unit.



## Modifying Anchoring Units for AB Fieldstone

- Removing the “wings” of the blocks will be needed on projects with curves, corners or step downs. For smooth outside curves, remove one or both of the “wings” from the back of the anchoring units and tighten the radius of the curve. Break wings off with a hammer and chisel in the existing score line to obtain a clean break.
- When working with corners and/or stepping down a wall, split an anchoring unit in half to tie the corner together. Split the block by using a hammer and chisel to make a break down the center of the block.
- On some projects you will need to modify the bottom lip of the block to fit on the course below. Use a hammer and chisel and tap along the lip to remove.

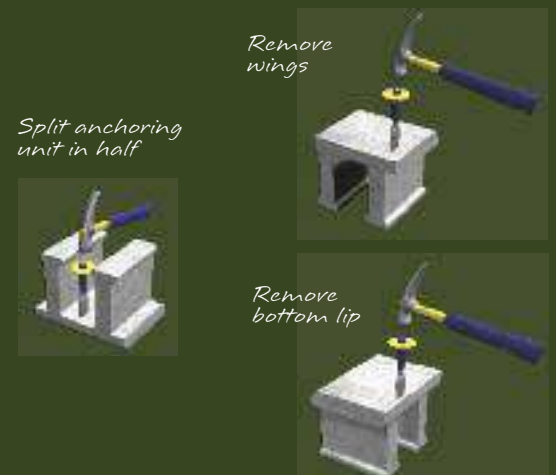

# Parapets and Posts



allanblock.com

*Creating Outdoor Spaces Has Never Been Easier*

AB Fieldstone Collection  
Sierra Series

## Parapets

The AB Fieldstone Collection can be used to build beautiful retaining wall structures and is versatile enough with its two-piece design, to build free standing parapets for patio enclosures, seating walls, fencing or planters. Finish off the top of a retaining wall or raised patio with a seamless transition, or build it on its own on an existing surface.

There are 2 options for building parapet walls:

**Standard** - where the AB Dogbones connect the facing units together. Easily build corners and parapets with posts. Offers the smallest width, for straight walls only.

**Wider** - where the AB Dogbones act as anchors in the wall rock allowing any size width to be created. Works well for straight and curved walls.

## AB Dogbone Units

AB Dogbone units are half the height of the AB Fieldstone facing units and require a minimum of two per facing unit on installation. We recommend installing one at the bottom and one at the top of the facing unit in a staggered effect with wall rock in between.

## Standard Parapets with Corners

Standard parapets are built so the AB Dogbone units connect the back of the AB Fieldstone facing units on either side of the parapet, connecting the two sides together. Corners are easily created and finishing the end is done by installing a post. The facing units can be randomly flipped upside down to give different facing appearances. For curves, see the wider parapets section.

- Starting at the location of the corner, install an 812 corner facing unit (A) on the outside of the parapet wall. Place an 812 facing unit perpendicular against the outside corner unit (B) to create the corner. Ensure the textured side of the corner unit is facing out. Place a bead of flexible concrete adhesive between units to hold in place during construction (optional).
- Build out the parapet wall in both directions with 812 and/or 824 facing units in the pattern and length desired.
- Place one dogbone unit in the facing unit (B) to assist with placement of the inside parapet wall.

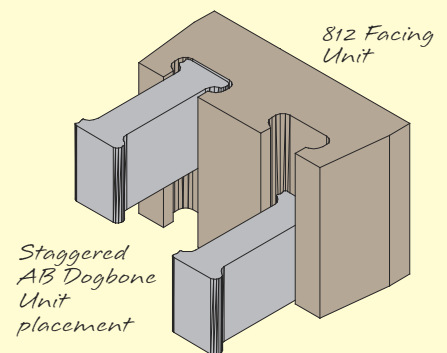

## Standard Parapets

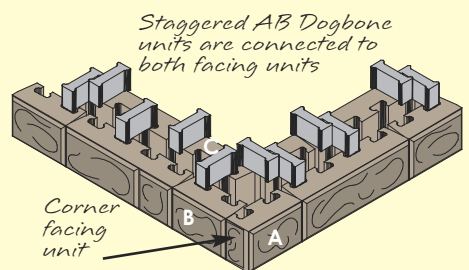

Parapet graphics are to show facing unit and AB Dogbone placements. All parapet installations need to include wall rock in cores.

- Install the first facing unit (C) to start the inside parapet. Align the first receiving slot of the facing unit to slide onto the dogbone unit (C). This will connect and align the outside (B) and inside (C) parapet walls.
- To create the inside corner, one facing unit will need to be cut to ensure the receiving slots for the dogbone units line up. To find this space, place the next facing unit to match up with fifth receiving slot from the corner in the opposite direction as the previous block placed (D).
- Install a dogbone unit in the fifth receiving slot between the outside and inside facing units just installed. Adjust alignment of facing unit so back slots line up properly so dogbone unit connects the two units together.
- Measure the space and cut an 812 facing unit to finish inside corner (E).
- Build out the parapet wall in both directions with 812 and/or 824 facing units in the pattern and length desired. Ensure all facing units are level.
- Start placement of the staggered dogbone units. Place one dogbone unit per each facing unit the length of the wall. Adjust alignment of facing units as needed for proper alignment and the dogbone unit connects the facing units together.
- Carefully install wall rock in a 4 in. lift (100 mm) to the height of the lower dogbone units the length of the entire wall. External jigs or supports may be required.
- Place second dogbone unit in each facing unit on top of the wall rock and level with or just below the top of the facing unit. Ensure each facing unit has a minimum of two dogbone units. Finish course by installing wall rock in a 4 in. lift (100 mm) to the top of the facing unit the entire length of the wall.
- On additional courses, use the same process as above, but reverse the direction of the outside corner block and the cut block on the inside of the corner. This ensures the seams from the block do not line up with the next course - locking the courses together.
- Repeat this process to height desired finishing at a post.

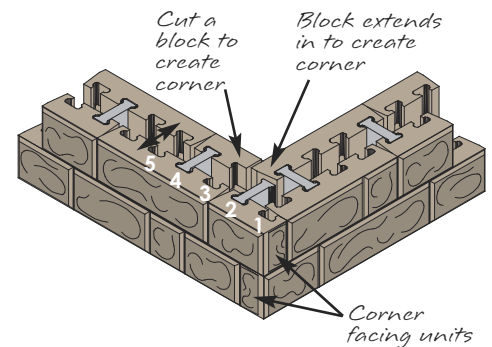
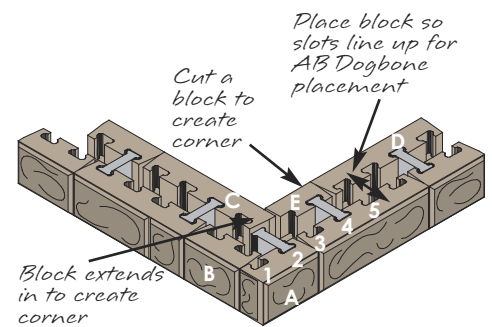

## Posts

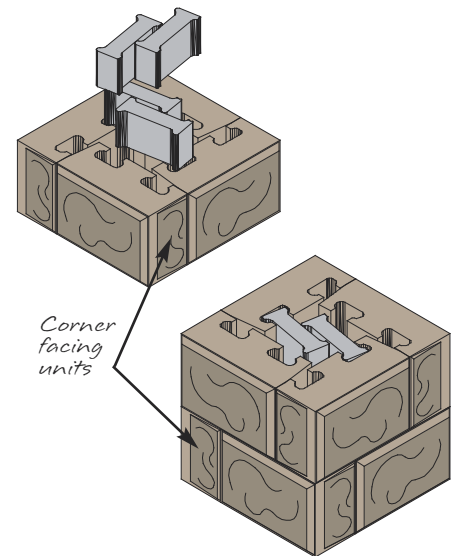

## Posts

Stand alone posts are built using four corner facing units per course. These blocks have a textured side as well as a face. Wider posts can be built by adding cut or full length 812 facing units between each corner facing unit.

Every facing unit needs to have one AB Dogbone unit to secure it in place. Place a bead of flexible concrete adhesive between units to hold in place during construction (optional). Fill posts with wall rock in 4 in. (100 mm) lifts to allow for staggered placement of AB Dogbone units.

## Posts and Standard Parapets

When building posts within the wall or ending a wall, corner facing units are not necessary where the wall meets the post as the textured side will not be visible. If the last post course extends above the parapet height, four corner facing units will then be needed.

On alternating courses, where a parapet wall meets a post, you will need to cut an 812 facing unit in half to offset from the seams below to allowing for proper AB Dogbone installation.

## Posts and Standard Parapets

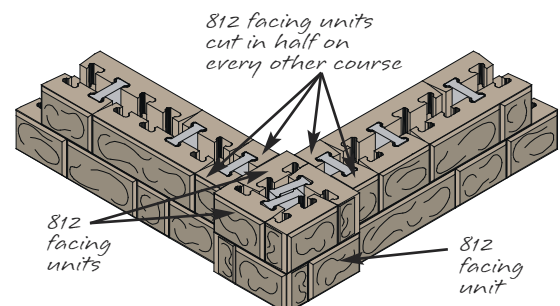
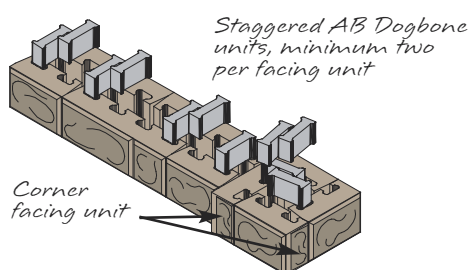

Parapet graphics are to show facing unit and AB Dogbone placements. All parapet installations need to include wall rock in cores.

# Parapets and Posts Cont.

## Wider Parapets - Example 1

Building wider parapets will use some of the same installation details as a standard parapet. A minimum of two AB Dogbones units are needed per facing unit. Depending on the width chosen, cutting a block may be necessary to create the end of a wider parapet. Here are two examples on how to end the parapet wall.

- Starting at an end of the parapet, install two 812 corner facing units perpendicular to each other, textured side facing out. Place a bead of flexible concrete adhesive between units to hold in place during construction (optional).
- Place 812 and/or 824 facing units running down both sides of the parapet to the length desired. To finish, repeat previous step using two 812 corner facing units, textured sides facing out, to finish the first course. Ensure all facing units are level.
- Start placement of the staggered dogbone units. Place one dogbone unit per each facing unit the entire length of the wall. Dogbone units will not connect the facing units together.
- Carefully install wall rock in a 4 in. lift (100 mm) to the height of the lower dogbone units the length of the entire wall. External jigs or supports may be required.
- Place second dogbone unit in each facing units on top of the wall rock and level with or just below the top of the facing unit. Ensure each facing unit has a minimum of two dogbone units. Finish course by installing wall rock in a 4 in. lift (100 mm) to the top of the facing unit the entire length of the wall.
- On additional courses, use the same process as above, but reversing the corner blocks placement to stagger the seams from the course below. The facing units can be randomly flipped upside down to give different facing appearances.
- Repeat this process to height desired.

## Wider Parapets - Example 2

Wider parapets can be created by adjusting how the end is built. In this example one facing unit will need to be cut at the end of every course.

- Starting at an end of the parapet, install two 812 corner facing units side by side, textured side facing out, to create the end (A). Place a bead of flexible concrete adhesive between units to hold in place during construction (optional). Install facing units running down both sides of the parapet in the pattern and length desired. Ensure all facing units are level.
- Install dogbone units in 4 in. (100 mm) lifts, as shown on page 50.
- On next course, change the corner facing units placement by using two 812 corner facing units (B) and an 824 facing unit (C). The 824 facing unit (C) will need to be cut to fit. Place a bead of flexible concrete adhesive between units to hold in place during construction (optional).
- Repeat this entire this process to height desired.

## Wider Parapets with Corners

Follow the standard parapet instructions on page 50 for facing unit placement to create the corner. When possible, always start the project at the corner. A minimum of two dogbones units are needed per facing unit, secure corner with a flexible concrete adhesive to hold in place during construction (optional).

- Space out parapet to the width desired. Place dogbone units and wall rock as done previously in 4 in. lifts (100 mm) to top of facing unit. Dogbone units will not connect the facing units together. External jigs or supports may be required.

## Wider Parapets - Example 1

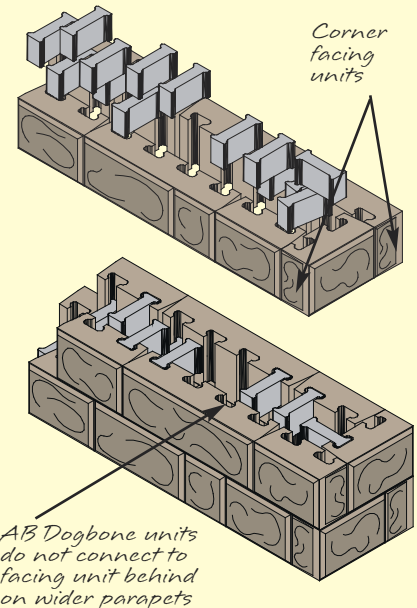

## Wider Parapet - Example 2

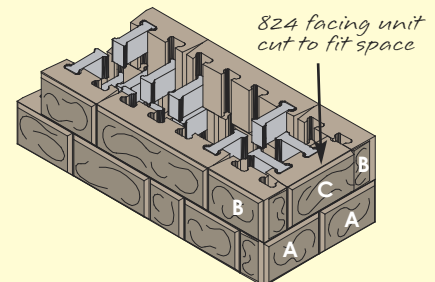

## Wider Parapets with Corners

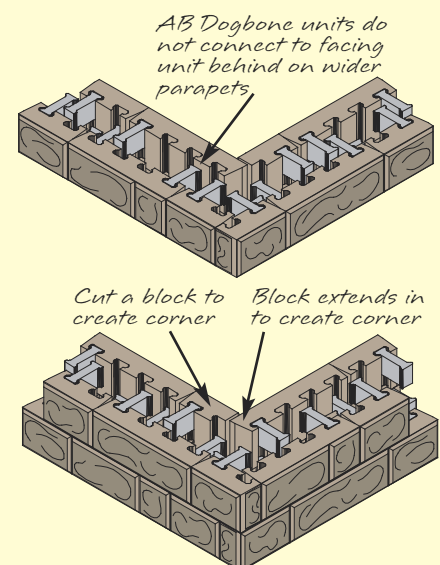

Parapet graphics are to show facing unit and AB Dogbone placements. All parapet installations need to include wall rock in cores.

## Wider Curved Parapets

Curved parapets can easily be incorporated with any wider parapet application. For curved parapets to work, the walls need to have a wider spacing between them to fit the AB Dogbone units and allow the turn of the curve. The back slots of the facing units will not line up through the curve so using a standard parapet width is not possible. A minimum of two AB Dogbone units are needed per facing unit.

- To create the curve, start on one side of the parapet and install the 812 facing units in the direction of the curve or serpentine. Keep the front of the facing units tight together. If building a tighter curve, start on the outside curve side of the wall to limit any gaps that could appear. Install entire length of this side of the parapet wall, ensuring all facing units are level.
- Install one dogbone unit in the first facing unit in the curve to determine placement of back side of parapet. Place the back of an 812 facing unit against the end of the dogbone unit or spaced away farther to determine width of the parapet. Dogbone units will not connect the facing units together on curves.
- Once the spacing between the facing units is determined, measure between the backs of the two facing units and/or create a jig (piece of wood cut to size) to easily determine spacing of facing units for the rest of the wall.
- Install the remaining facing units to create the back side of the curved parapet wall using the measurement or spacing jig the length of the wall.
- Start placement of the staggered dogbone units. Place one dogbone unit per each facing unit the length of the wall. Dogbone units will not connect the facing units together. Adjust and align facing units as needed to fit.
- Carefully install wall rock in a 4 in. lift (100 mm) to the height of the lower dogbone units the length of the entire wall. External jigs or supports may be required.
- Place second dogbone unit in each facing units on top of the wall rock and level with or just below the top of the facing unit. Ensure each facing unit has a minimum of two dogbone units. Finish course by installing wall rock in a 4 in. lift (100 mm) to the top of the facing unit the entire length of the wall.
- If ending a curved parapet at a post or vertical end, cutting facing units to create the transition may be required.
- Install additional courses in same process, offset from the course below. The facing units can be randomly flipped upside down to give different facing appearances.

## Retaining Walls and Parapets

If installing a parapet on top of an AB Fieldstone retaining wall, stack facing units so they are staggered from the blocks below so the seams are offset from the course below creating a clean transition.

Use a course of long anchoring units (LAU) on the top course of the retaining wall to create a level surface to build the parapet on for easy installation.

## Capping Parapets

Check with your local distributor for available options to cap the top of the parapets based on the width installed. Secure in place with a flexible concrete adhesive. Using a capping option that is slightly wider than the parapet is recommended. The extra overhang will create a nice finished effect.

## Curved Parapets

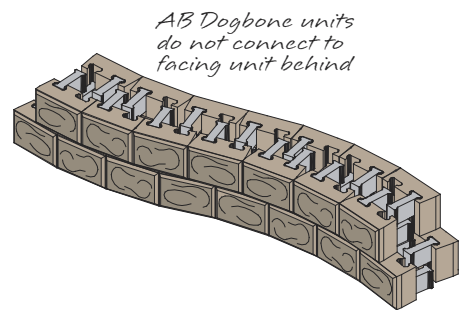
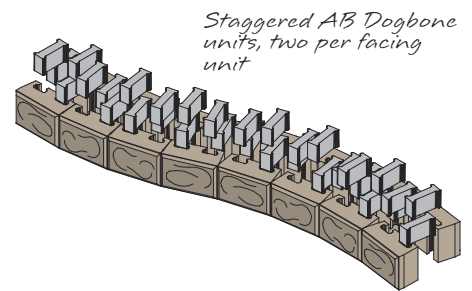

Parapet graphics are to show facing unit and AB Dogbone placements. All parapet installations need to include wall rock in cores.

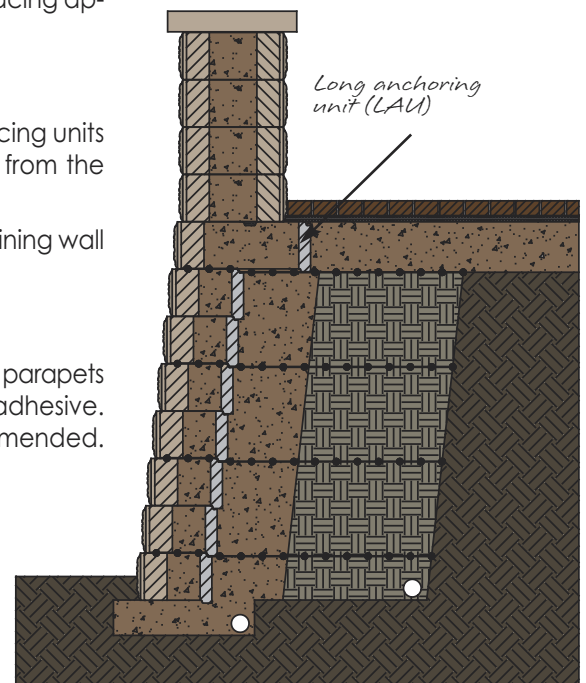

# Finishing Options

**Finish your wall with style.**



allanblock.com

AB Collection

## Capping Walls

Allan Block Capstones are available to finish the top of the wall. The raised front-lip provides a perfect built-in edging where you can simply use rock, mulch, grass or planting soil to complete the wall with an attractive, natural look. See page 30 for information on capping AB Fieldstone walls.

## Capping Curves

- Place two caps on top of the wall, spaced so a third cap will fit tightly between their widest point.
- Set another cap on top of the first two caps and mark where they overlap on the bottom of the center cap.
- Remove the center cap and cut along the marks.
- Set the middle cap back in place so the three fit tightly together.
- Repeat as often as needed to cap the entire curve.
- It is a good idea to secure caps with a high strength flexible masonry adhesive once they are all cut.



## Capping Corners

- Cut caps at 45° angles to complete the outside corner.
- It is a good idea to secure caps with a high strength flexible masonry adhesive once they are all cut.

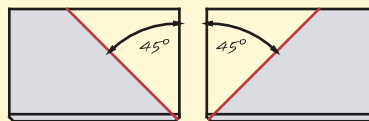



## Capping Tighter Curves

- Place two caps on the wall with the back of each cap tight together. A gap will appear in the front.
- Measure the distance of the gap between the 2 caps (x) at the front of the wall.
- Measure out this distance (x/2) on the back of each of the cap and mark.
- Draw a line from the mark to the front corner.
- Use a masonry saw to cut each cap.

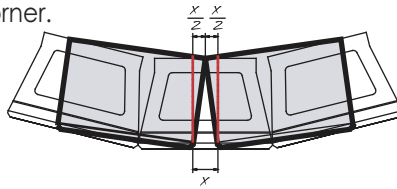

Finish your wall with plantings or mulch in place of caps.

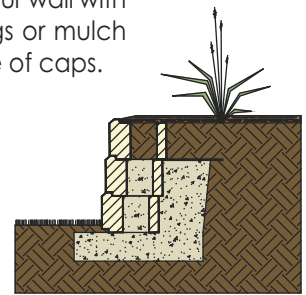

## Finishing Walls with Plantings or Mulch

- Allan Block's patented raised front lip provides a built-in edging for landscape rock, mulch, grass or soil.



AB Collection - with mulch



AB Fieldstone Collection - with caps



AB Collection - with rocks

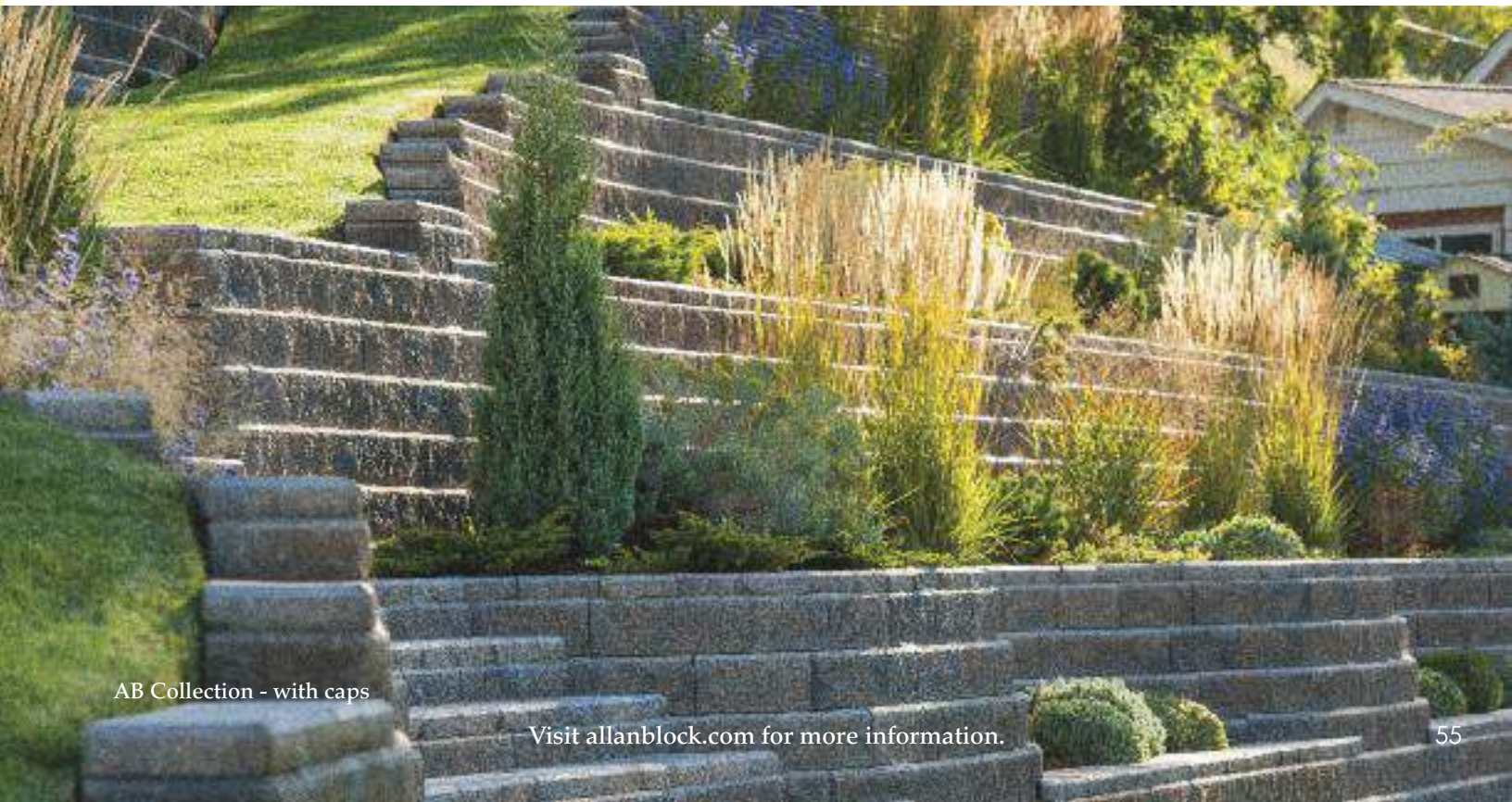

AB Collection - with caps

# Construction & Inspection Checklist



allanblock.com

To ensure that the basics of the retaining wall project are covered, use the following construction and inspection checklist. For a thorough procedure use this list as a guide to prepare your project specific checklist and to review the most common points. It may also be used during the bidding process or a pre-construction meeting to ensure that all special provisions are complied with. Always check the local building codes, document any changes to the plan in writing, and notify the wall design engineer with any concerns on water management.

## Review wall design plans for:

### A. Compliance of site to latest site plan

- Does the site plan and wall layout coincide with current site conditions?
- Have all slopes above and below the walls been taken into account on the plans?
- Do the section drawings match the topography of the job-site?
- Have site utilities been accounted for?
- Are there any recommendations for changes to the site plans to accommodate the wall?

### B. Review of reported soil conditions with on-site soils engineer

- Are on-site soils consistent with soil parameters used in wall design?
- Does the site show indications of multiple types of soil, and has this been accounted for?
- Is there evidence of landfill areas on site?
- Has the owner contracted with a geotechnical engineering firm for overall / global stability outside the wall design envelope (H tall by the greater of 2H or  $H_e + L$  long)?

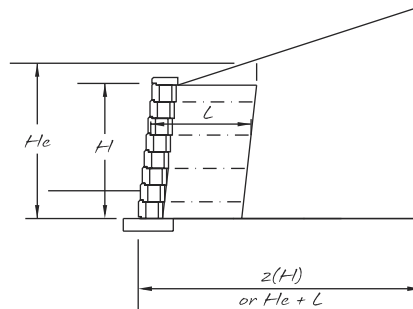

### C. Review of above-grade water management with project civil engineer

- Has surface runoff been accounted for in the site design?
- Will this site be irrigated?
- If storm drains become inoperable where will the water migrate to?
- During renovation of land will temporary drainage be an issue?

### D. Review of below grade water management with wall design engineer and general contractor

- How and where will drain pipe be installed?
- Is it possible to vent drain pipe to daylight?
- Is venting to a storm drainage system an option?
- Will outlets be located and protected from blockage or damage?

### E. Surcharges

- Have all surcharges been accounted for?
- During construction are there any temporary surcharges that should be accounted for?

## Review Construction Details and Procedures:

- Mark station points for top and bottom of wall elevation and change in wall direction.
- Identify changes in grid lengths, location of grids, and types of grid to be used.
- Determine and locate proper base size for each section of wall.
- Verify that the correct type and color of block has been ordered and delivered to the job.
- Verify that the foundation soil and retained soil conform to design requirements.
- Verify that infill soil meets design standards.
- Verify that compaction testing will be performed, who is responsible, at what intervals of locations along the wall, and what coordination will be required.
- Determine what method will be used to verify construction materials, methods, and sequence of construction. (ie: written documentation of as built, full time inspector on site, photographic documentation.)
- Wall contractor is responsible for quality control of wall installation per the approved plans. The owner or owner's representative is responsible for engineering and quality assurance of the project.

## Estimating the Number of Blocks Needed

Allan Block makes it easy to estimate materials. Use the **Estimating Charts** below to quickly estimate the amount of block and capstones that will be needed for your retaining walls up to 6 ft. (1.8 m) high.

You can also use our **Estimating Software** or **Residential Retaining Walls App** to calculate the block as well as the amount of base materials, drain pipe and AB Reinforcement Grid needed to complete the project. Call or visit your local Allan Block Dealer or go to [allanblock.com](http://allanblock.com) to **download the FREE Estimating Software or Apple's App Store for our App.**

<b>AB Fieldstone Collection®</b>						
Approx. number of 812 facing units needed						
Wall Height	Wall Length					
	5 ft (1.5m)	10 ft (3.0m)	20 ft (6.0m)	30 ft (9.0m)	40 ft (12.0m)	50 ft (15.0m)
1 course 8 in. (200 mm)	5	10	20	30	40	50
2 course 16 in. (400 mm)	10	20	40	60	80	100
3 course 24 in. (600 mm)	15	30	60	90	120	150
4 course 32 in. (800 mm)	20	40	80	120	160	200
5 course 40 in. (1.0 m)	25	50	100	150	200	250
6 course 48 in. (1.2 m)	30	60	120	180	240	300
To switch to AB Fieldstone 824 facing units, simply divide the number shown above in half.						
Capstones	4	8	15	23	30	38
Note: Capstones add 3.5 in. (90 mm) to your total wall height.						

## Patterned Walls

For the **AB, AB Europa and AB Aztec Collections** see page 28 for a detailed chart on the amount of block needed.

For patterned walls using the **AB Fieldstone Collection** with a 50/50 mix, divide the number shown above in half for the amount of 812 units then divide this number in half again for the amount of 824 units needed.

<b>AB® Collection, AB Aztec Collection™ or AB Europa® Collection</b>						
Approx. number of full-size blocks needed (AB Stones, AB Classic, AB Aztec Stones, AB Aztec Classic, AB Dover)						
Wall Height	Wall Length					
	5 ft (1.5m)	10 ft (3.0m)	20 ft (6.0m)	30 ft (9.0m)	40 ft (12.0m)	50 ft (15.0m)
1 course 8 in. (200 mm)	4	7	14	21	28	35
2 course 16 in. (400 mm)	7	14	28	41	55	69
3 course 24 in. (600 mm)	11	21	41	62	82	103
4 course 32 in. (800 mm)	14	28	55	82	109	137
5 course 40 in. (1.0 m)	18	35	69	103	137	171
6 course 48 in. (1.2 m)	21	41	82	123	164	205
To switch to half-width blocks (AB Jumbo Jr, AB Aztec Jr. or AB Palermo), simply double the numbers shown above.						
Capstones	4	7	14	21	28	35
Corner Blocks	1 for each course that steps down. 1 for each course with a corner.					
Note: Capstones add 4 in. (100 mm) to your total wall height. Corners should alternate with left and right hand blocks.						

<b>Approx. number of half-high blocks needed (AB Lite Stone, AB Aztec Lite Stone or AB Barcelona)</b>						
Wall Height	Wall Length					
	5 ft (1.5m)	10 ft (3.0m)	20 ft (6.0m)	30 ft (9.0m)	40 ft (12.0m)	50 ft (15.0m)
2 courses 8 in. (200 mm)	7	14	28	41	55	69
3 courses 12 in. (300 mm)	11	21	41	62	82	103
4 courses 16 in. (400 mm)	14	28	55	82	109	137
5 courses 20 in. (500 mm)	18	35	69	103	137	171
6 courses 24 in. (600 mm)	21	41	82	123	164	205
7 courses 28 in. (700 mm)	24	48	96	143	191	239
To switch to half-width blocks (AB Jr Lite, AB Aztec Jr Lite or AB Bordeaux), simply double the numbers shown above.						
Capstones	4	7	14	21	28	35
Note: Capstones add 4 in. (100 mm) to your total wall height.						

Most municipalities require permits for walls over 4 ft. (1.2 m). Contact your local AB Dealer, city building official or a local engineer for assistance.

For projects taller than 3 ft. (0.9 m), we recommend using the larger sized blocks or building patterned walls. For information on determining the best block choice for your project go to [allanblockblog.com](http://allanblockblog.com).

# AB Courtyard Collection®



allanblock.com



AB Courtyard

*NEW Pre-Designed  
Patio Packages!*

## Create Elegant, Beautifully Textured Walls

The **AB Courtyard Collection** is a versatile two-sided patio wall system that can enhance the beauty of your landscape and backyard. Use the walls and posts/pillars to add privacy or separation between landscape elements. The timeless beauty and the simplicity of use make this a product of choice.

Combine AB Courtyard, Allan Block retaining walls and pavers to create stunning landscapes. The interlocking blocks easily fit together without mortar or pins. Simplicity, quality and lasting value, you get it all with the AB Courtyard Collection.



AB Courtyard

Download the  
AB Courtyard  
Estimating  
App Today



AB Old Country Courtyard

From patio enclosures, kitchens, to simple weekend projects, the AB Courtyard Collection allows you to easily create beautiful and durable stone-like structures. **Check out our new pre-designed Patio Packages that offers a complete design and layout package.** This versatile system can meet any design need. Create elegant and stylish surrounds with old world charm for any landscape.

See our website for complete details or ask your local dealer today for a copy of the **AB Courtyard Collection Installation Guide**. Visit our YouTube channel for installation videos.

Visit the  
Allan Block  
Channel



## AB Courtyard Patio Packages

Choose from one of our 12 pre-design **Patio Packages** to assist with your backyard layout. There are several to choose from so you can choose the one that works best for your space. All of the projects will easily fit in a 12 ft by 19 ft space (3.6 m by 5.8 m). **Find detailed instructions and complete installation videos for all the packages in our AB Courtyard Estimating App or our website at [allanblock.com](http://allanblock.com).**



*Create your outdoor room using the AB Courtyard Collection from Allan Block.*



### Merlot

The Merlot package offers a large flowing space with soft curves to allow for a defined border with built in seating on the walls. The curves can be created as cozy nooks or use the whole space as an extension of your home entertaining.

See How-to Sheet #510.



### Pinot

The Pinot package offers a intimate outdoor gathering area. A curved wall offers built-in seating and a modern feel to your surroundings. With clean lines and a warm, comfortable private space, it will soon be your new favorite hangout.

See How-to Sheet #525.



### Sonoma

The Sonoma package offers a warm and comfortable setting for friends and family to gather. With a large open space and an inviting bench that together, welcomes your guests for some open-air dining.

See How-to Sheet #535.





allanblock.com

AB Courtyard



AB Courtyard



AB Courtyard

***Create New Outdoor Rooms to Enjoy with Family and Friends.***



AB Old Country Courtyard  
AB Europa Wall behind

## *Retaining Walls, Courtyard and Pavers*

The Allan Block line of retaining wall products and the AB Courtyard Collection work perfectly together in matching colors and textures to create beautiful raised patios. Find your favorite paver style to finish it off to create an outdoor area with elegant style.



AB Europa Collection  
with AB Old Country Courtyard

***Allan Block has the system to satisfy every design.***



AB Collection  
with AB Courtyard

## *The Possibilities are Endless*

Allan Block has been used in thousands of unique applications throughout the world. For more information visit our web site at [allanblock.com](http://allanblock.com) for a full library of photos and instructional materials.

Contact your local AB Dealer for product availability. Our distinctive products and experienced people can make your vision a reality.



AB Collection  
with AB Courtyard



When you purchase Allan Block, you can feel confident that the Allan Block family of products have been created and engineered to deliver complete landscape solutions.

Visit our website at [allanblock.com](http://allanblock.com) for the latest information, product and color availability, and more.



[allanblock.com](http://allanblock.com)



Retaining Walls - Residential or Commercial



"Green" Retaining Walls - Residential or Commercial



Courtyard/Patio Walls



Fencing/Sound Barriers

Available At:



[allanblock.com](http://allanblock.com)

